

**Organizational Structure
Department of Health and Family Services
Division of Public Health**

March 2007

Fiscal / Budget Mgmt
Grants Monitoring
Contract Monitoring
Public Health Info
Webpage
Education / Training
Communications
Distance Learning
IT Network Security
Workforce Dev.

Personnel, Mail, Fleet
Printing, Forms, Records
Purchasing, Invoicing
Space
Telecommunications
IT Liaison
Performance Based Contracts
Division Receptionist
Desktop Support

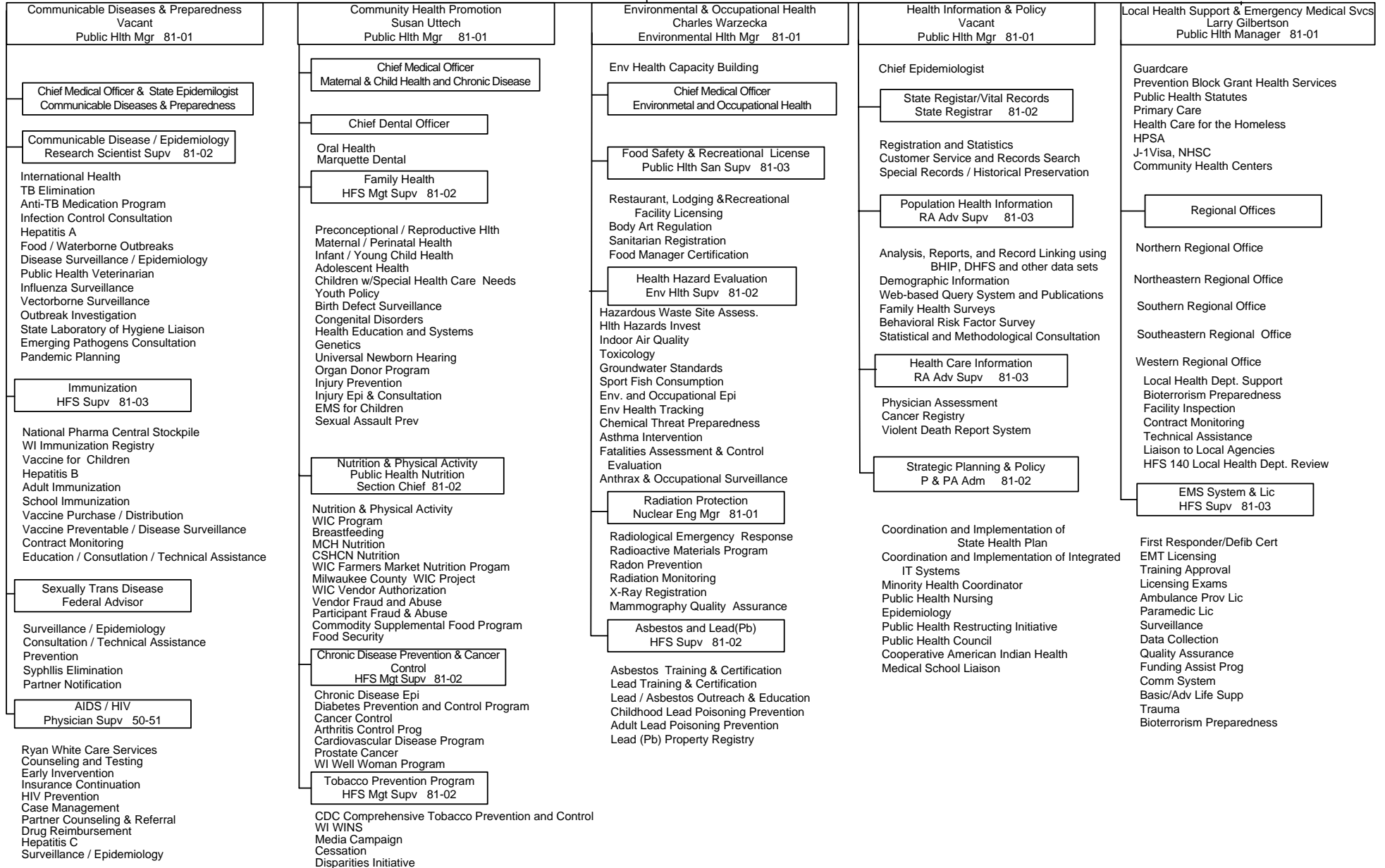
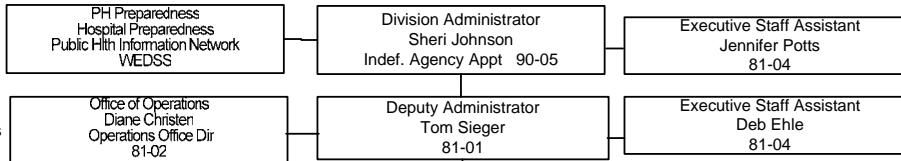

Division of Public Health Administrator's Office

March 2007

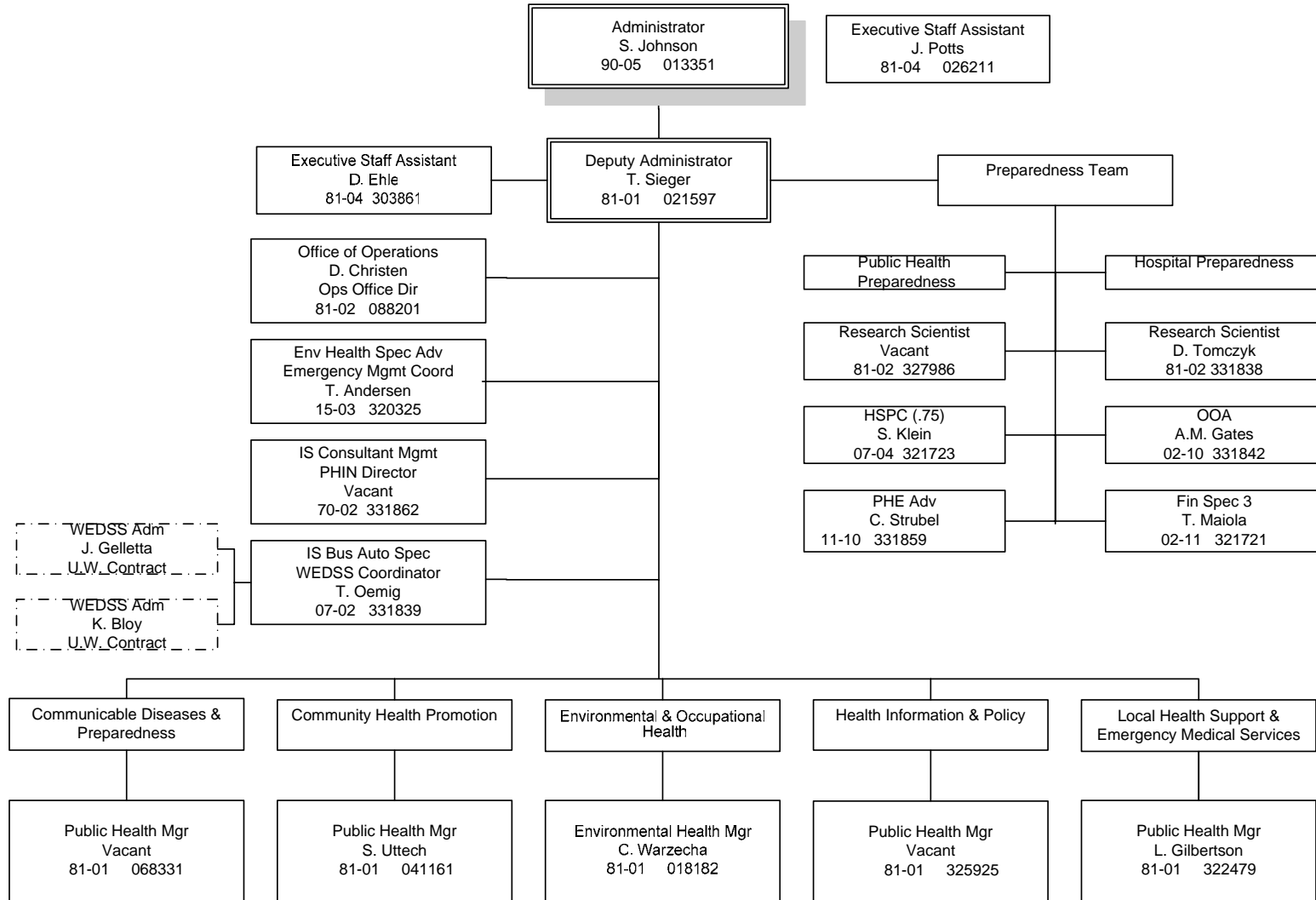

**Division Of Public Health
Office of Operations**

March 2007

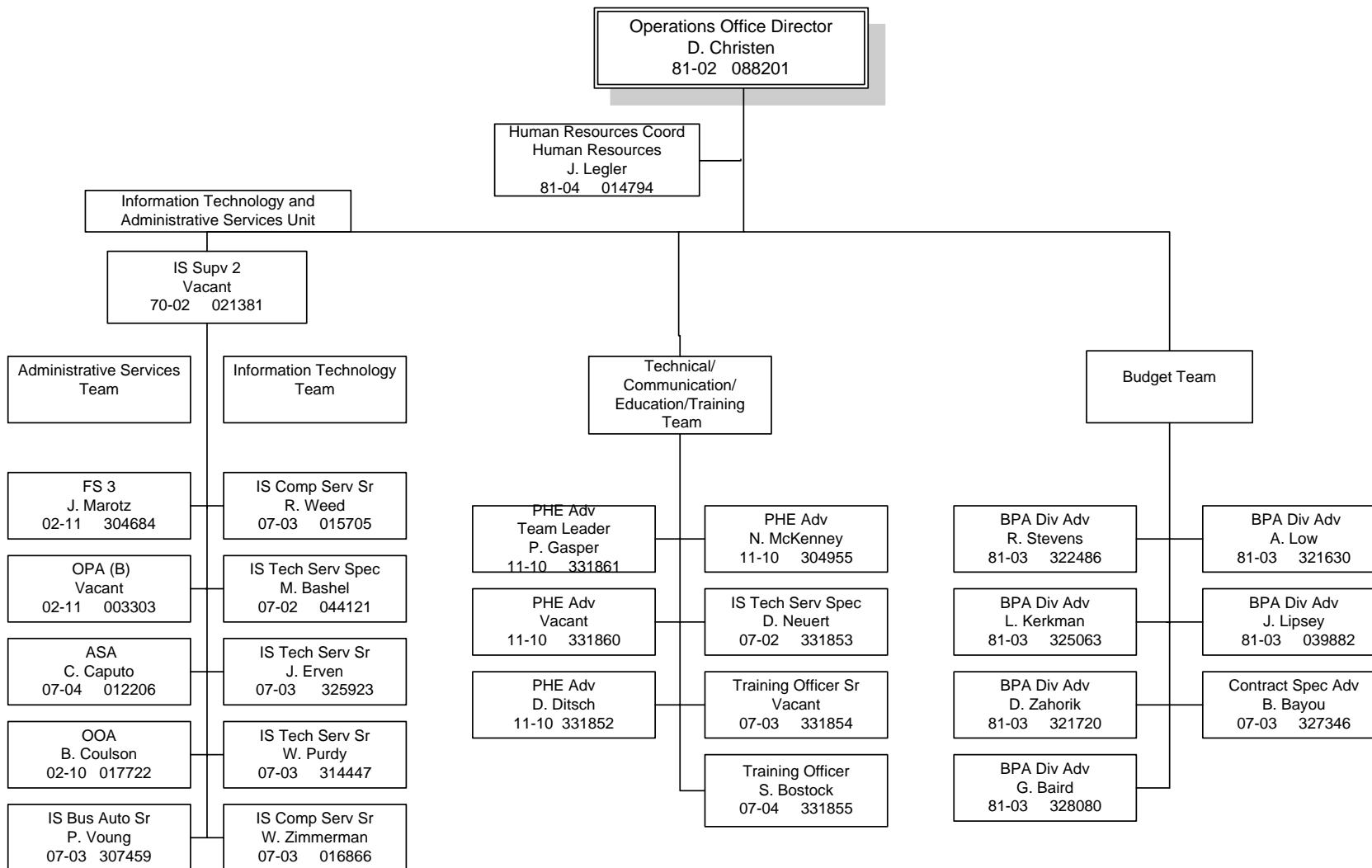

**Division of Public Health
Bureau of Communicable Diseases & Preparedness
Sexually Transmitted Disease Section**

March 2007

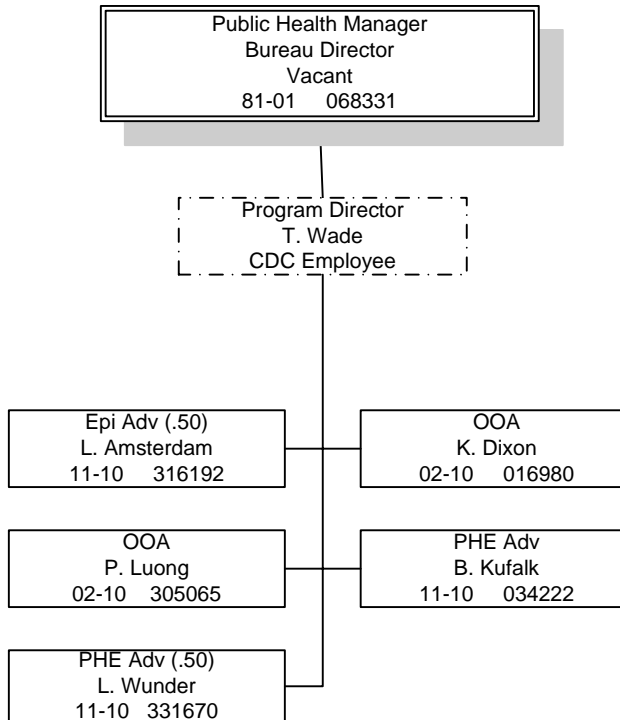

**Division of Public Health
Bureau of Communicable Diseases & Preparedness
AIDS / HIV Section**

March 2007

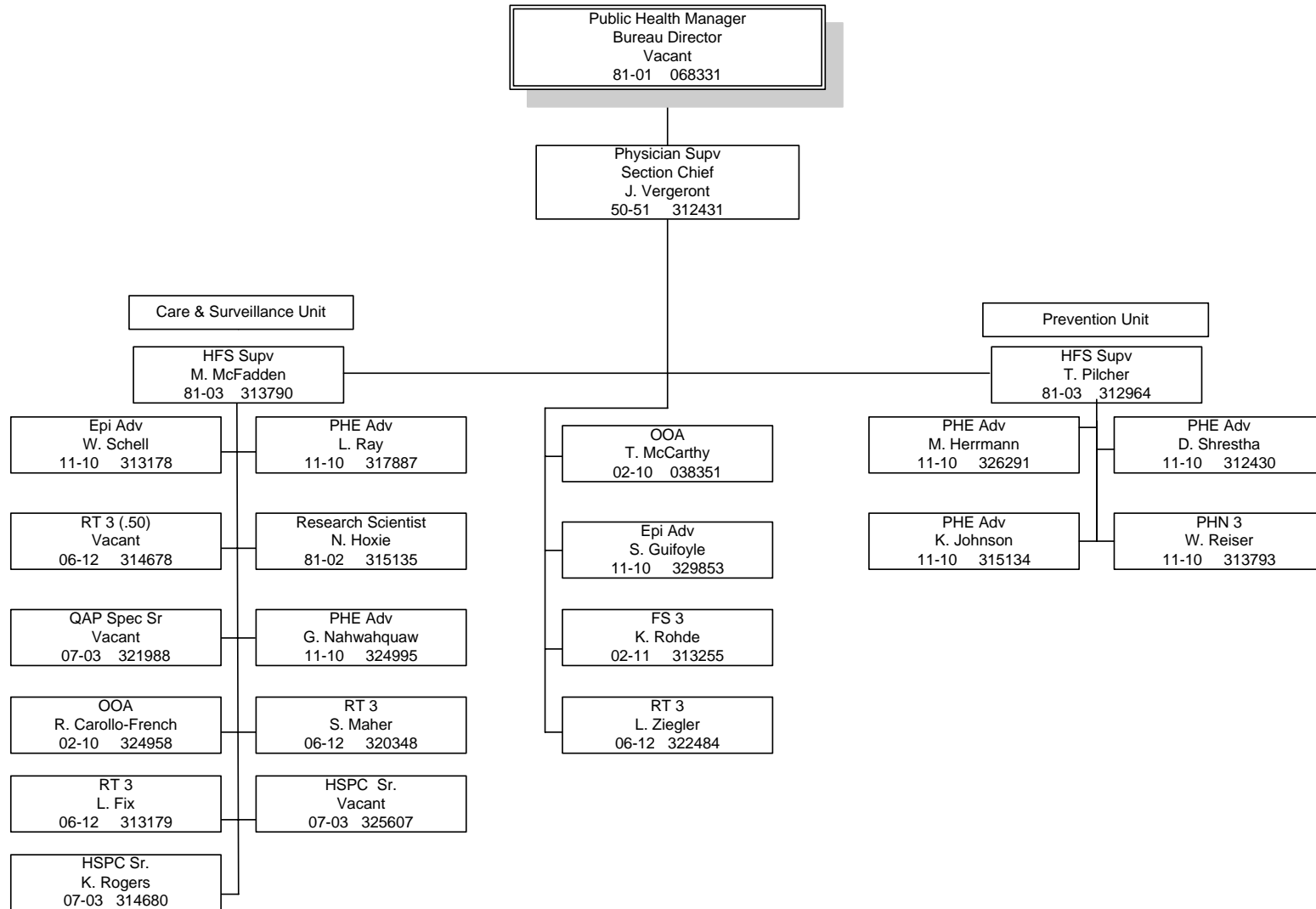

**Division of Public Health
Bureau of Communicable Diseases & Preparedness
Communicable Disease Epidemiology Section**

March 2007

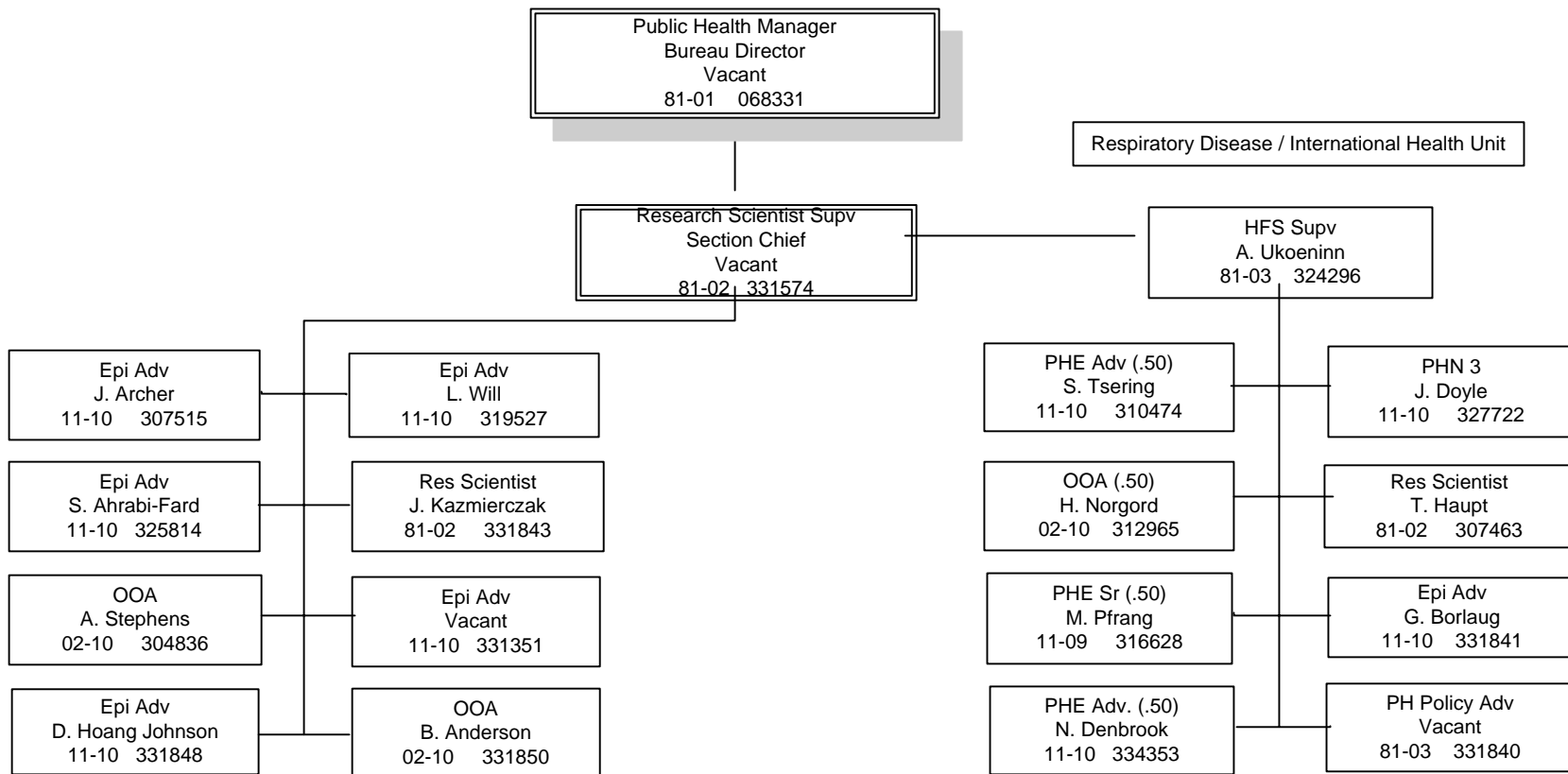

**Division of Public Health
Bureau of Communicable Diseases & Preparedness
Bureau Director's Office**

March 2007

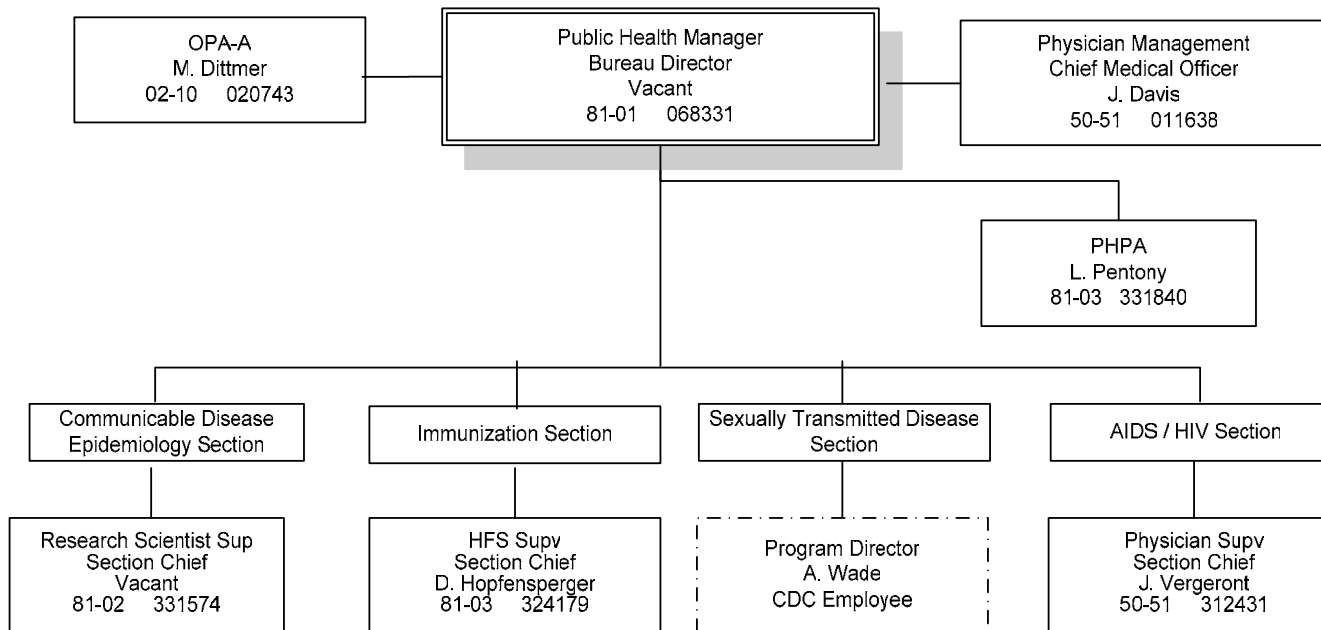

**Division of Public Health
Bureau of Communicable Diseases & Preparedness
Immunization Section**

March 2007

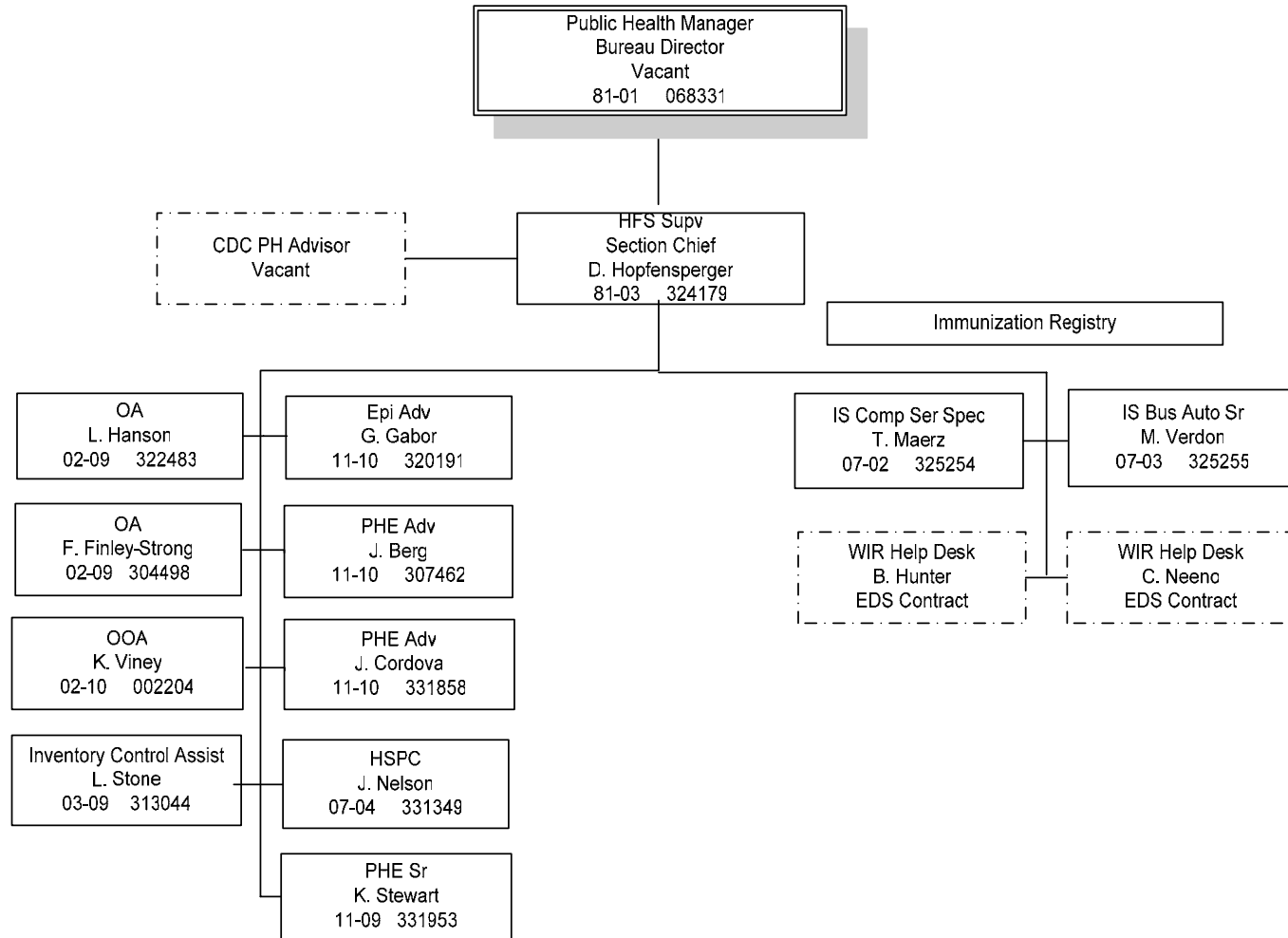

**Division of Public Health
Bureau of Community Health Promotion
Tobacco Prevention Section**

March 2007

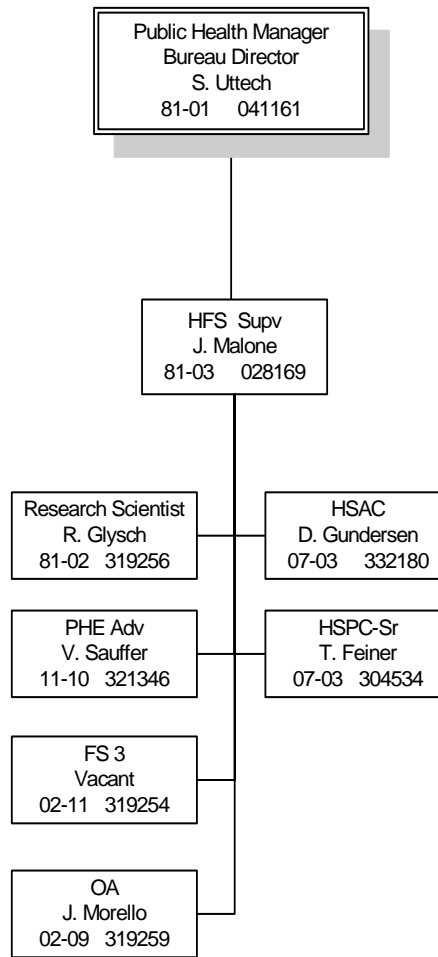

**Division of Public Health
Bureau of Community Health Promotion
Chronic Disease Prevention and Cancer Control Section**

March 2007

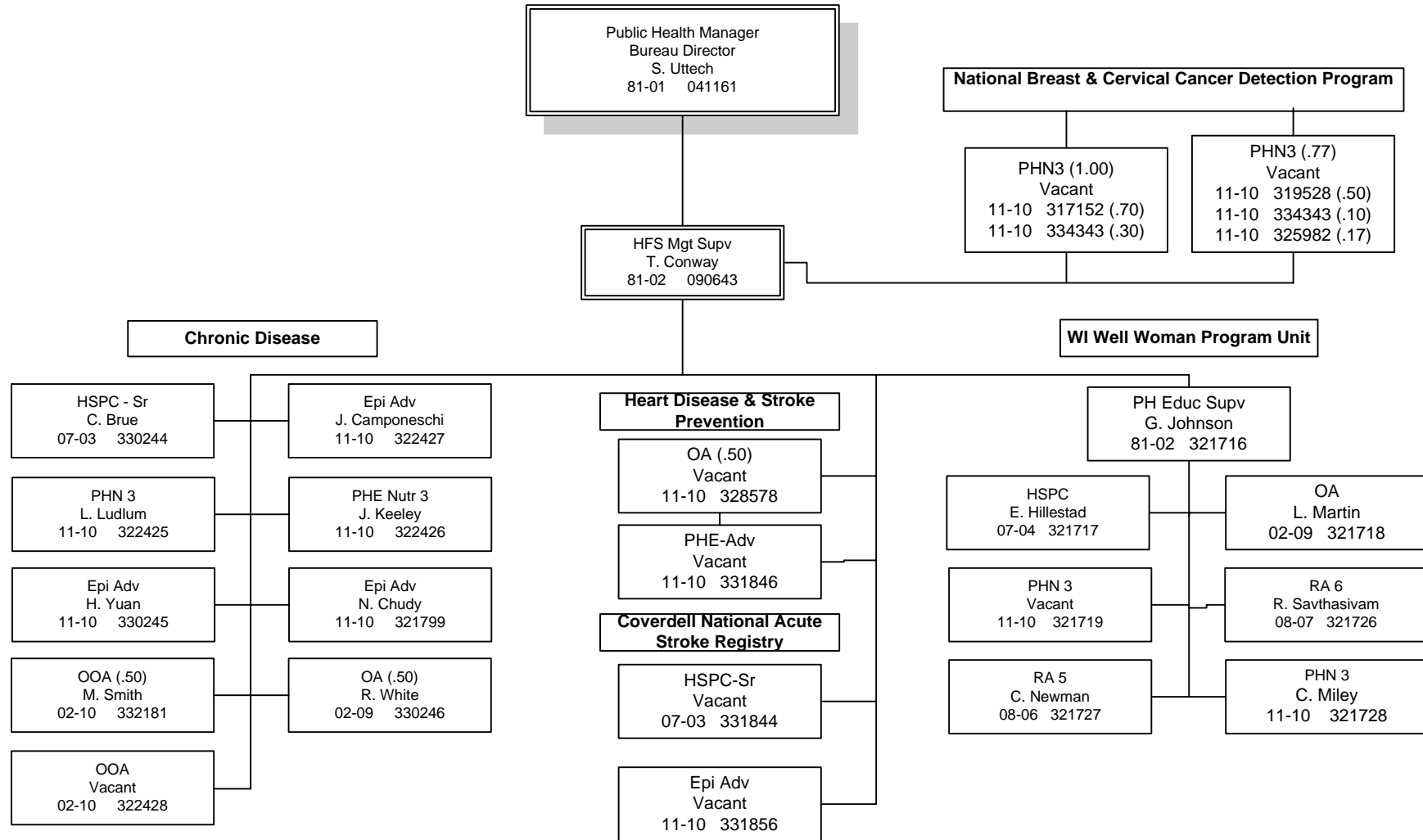

**Division of Public Health
Bureau of Community Health Promotion
Bureau Director's Office**

March 2007

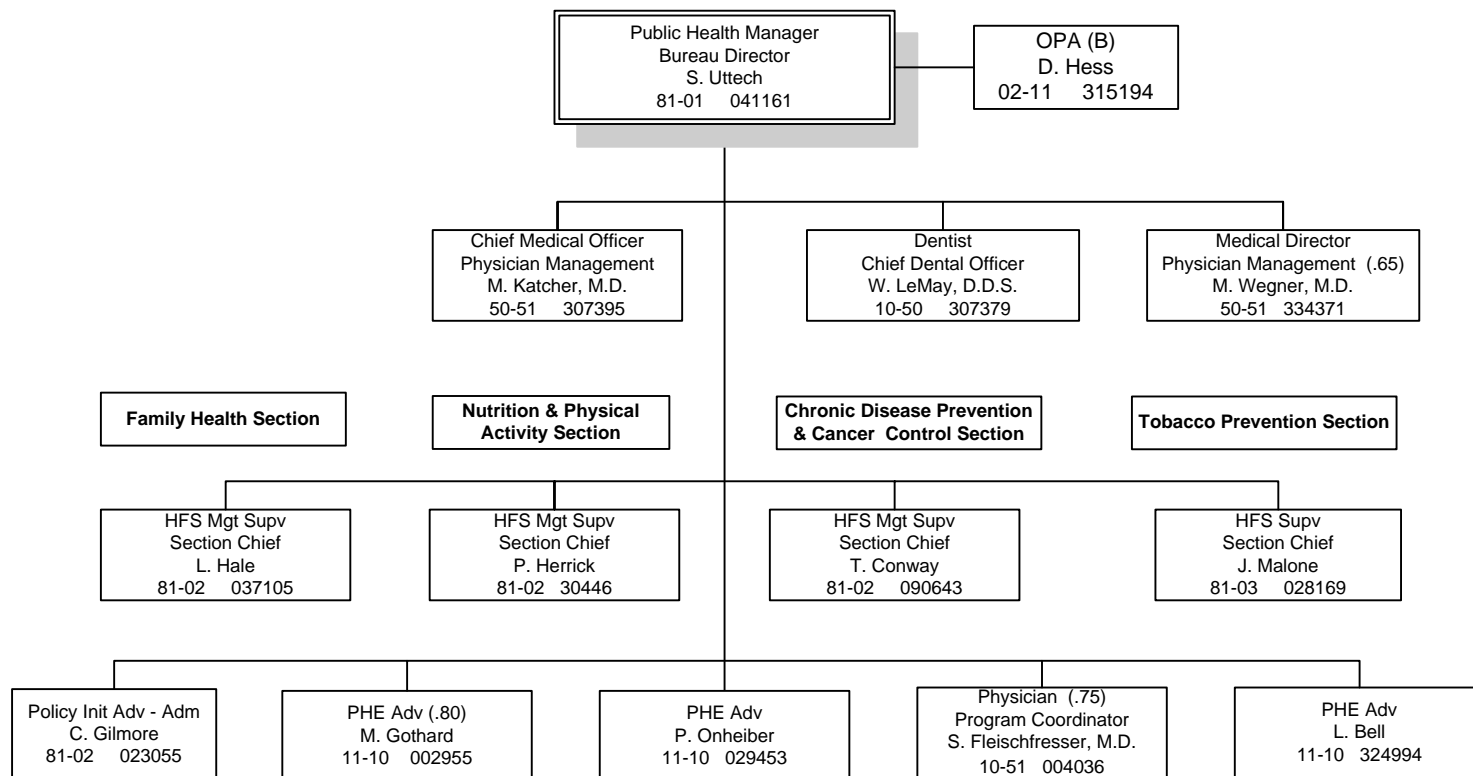

**Division of Public Health
Bureau of Community Health Promotion
Family Health Section**

March 2007

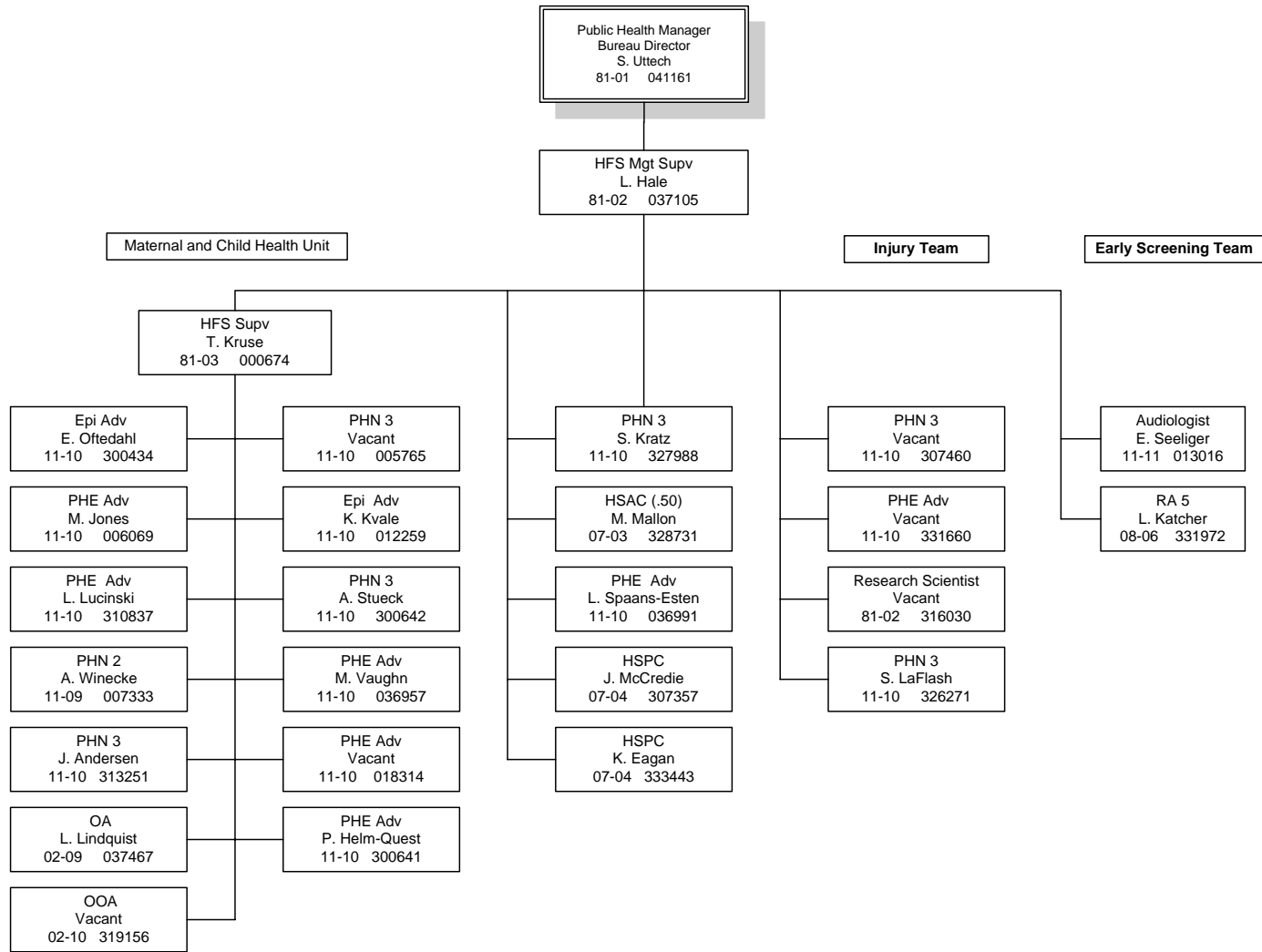

**Division of Public Health
Bureau of Community Health Promotion
Nutrition and Physical Activity Section**

March 2007

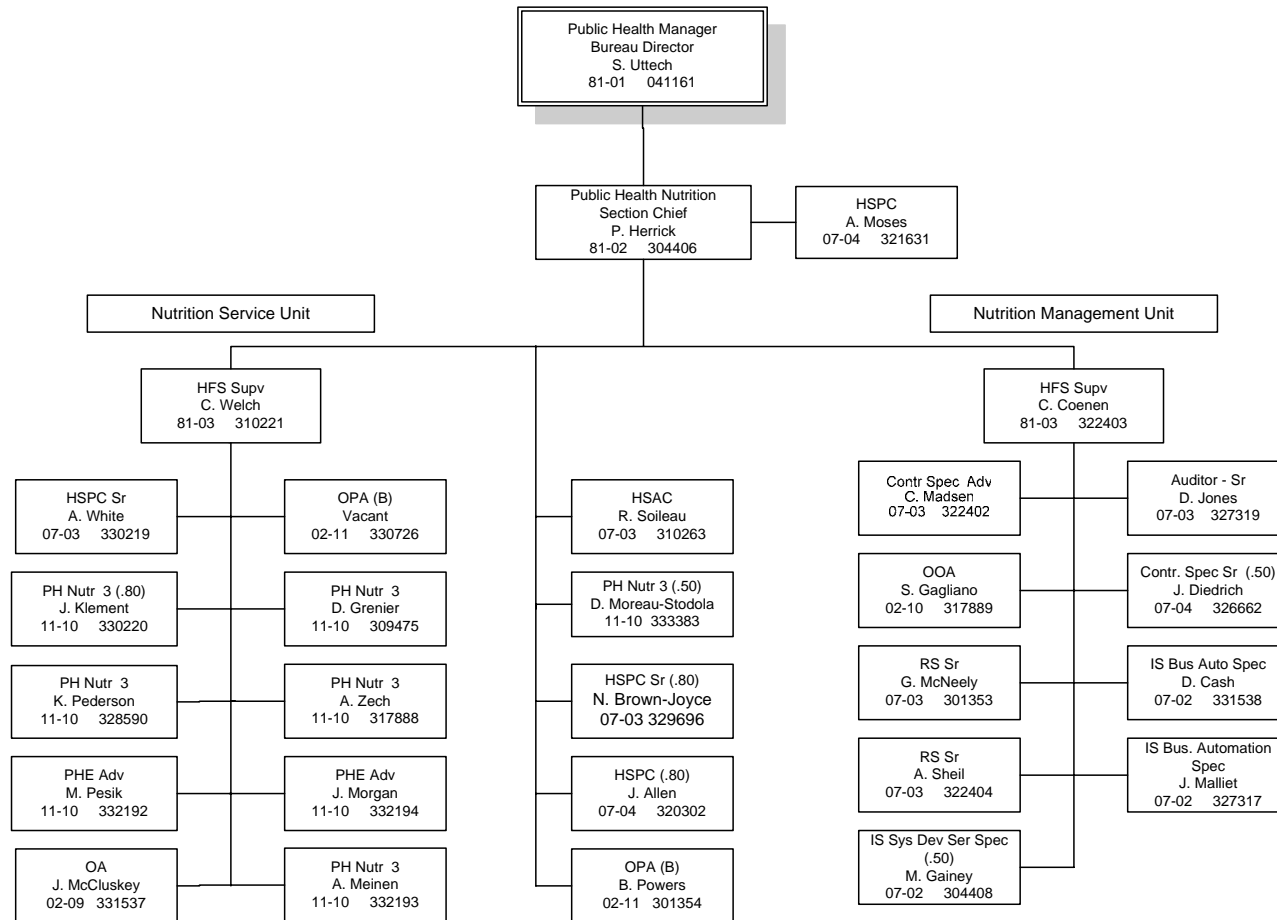

**Division of Public Health
Bureau of Environmental and Occupational Health
Radiation Protection Section**

March 2007

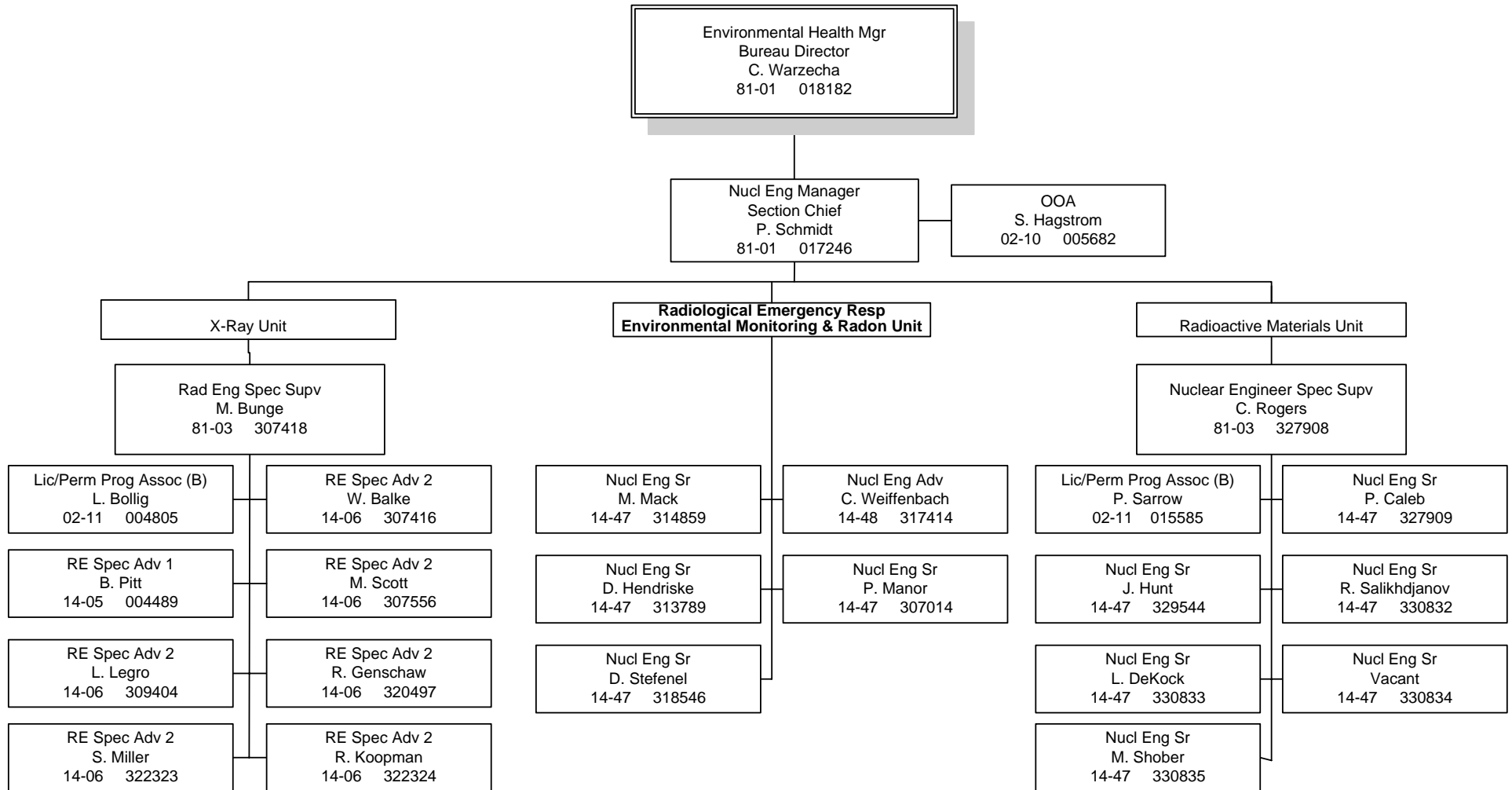

**Division of Public Health
Bureau of Environmental & Occupational Health
Bureau Director's Office**

March 2007

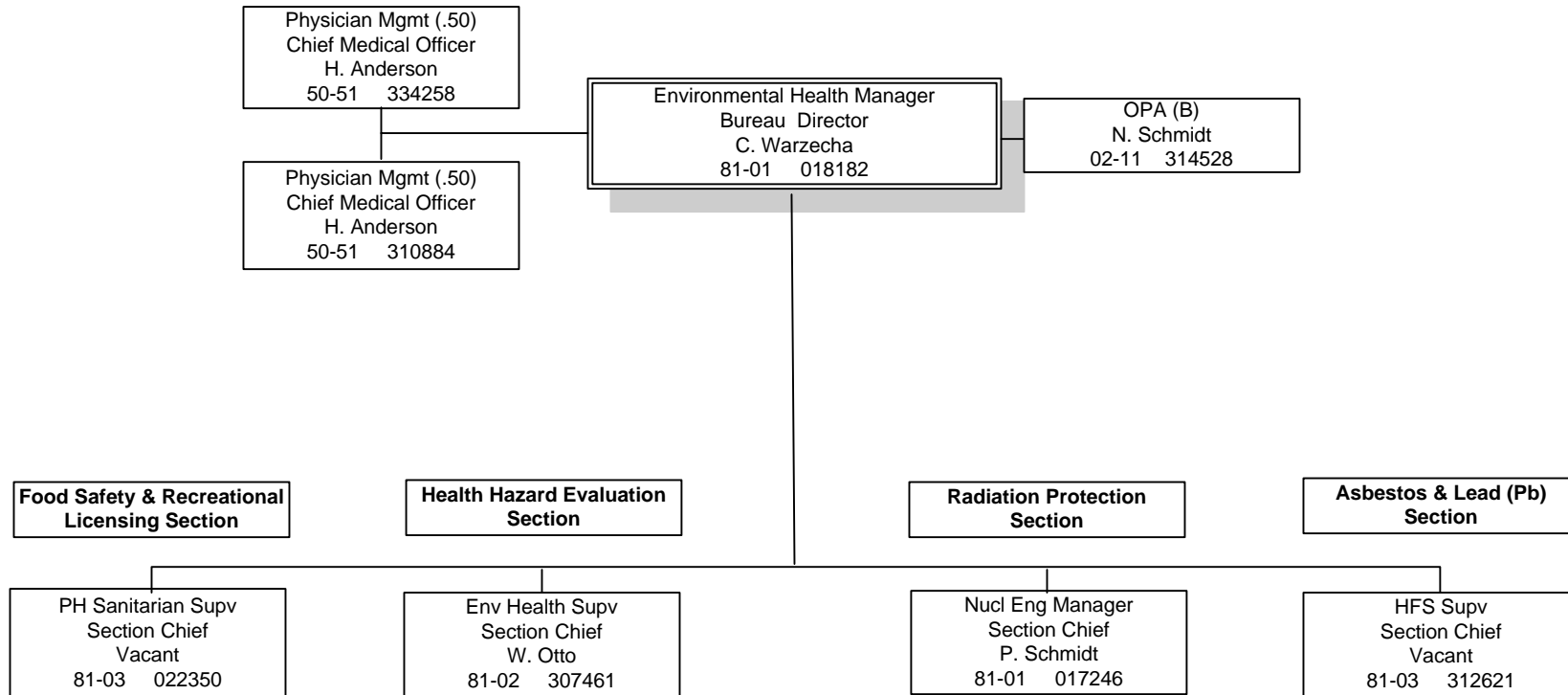

**Division of Public Health
Bureau of Environmental and Occupational Health
Food Safety & Recreational Licensing Section**

March 2007

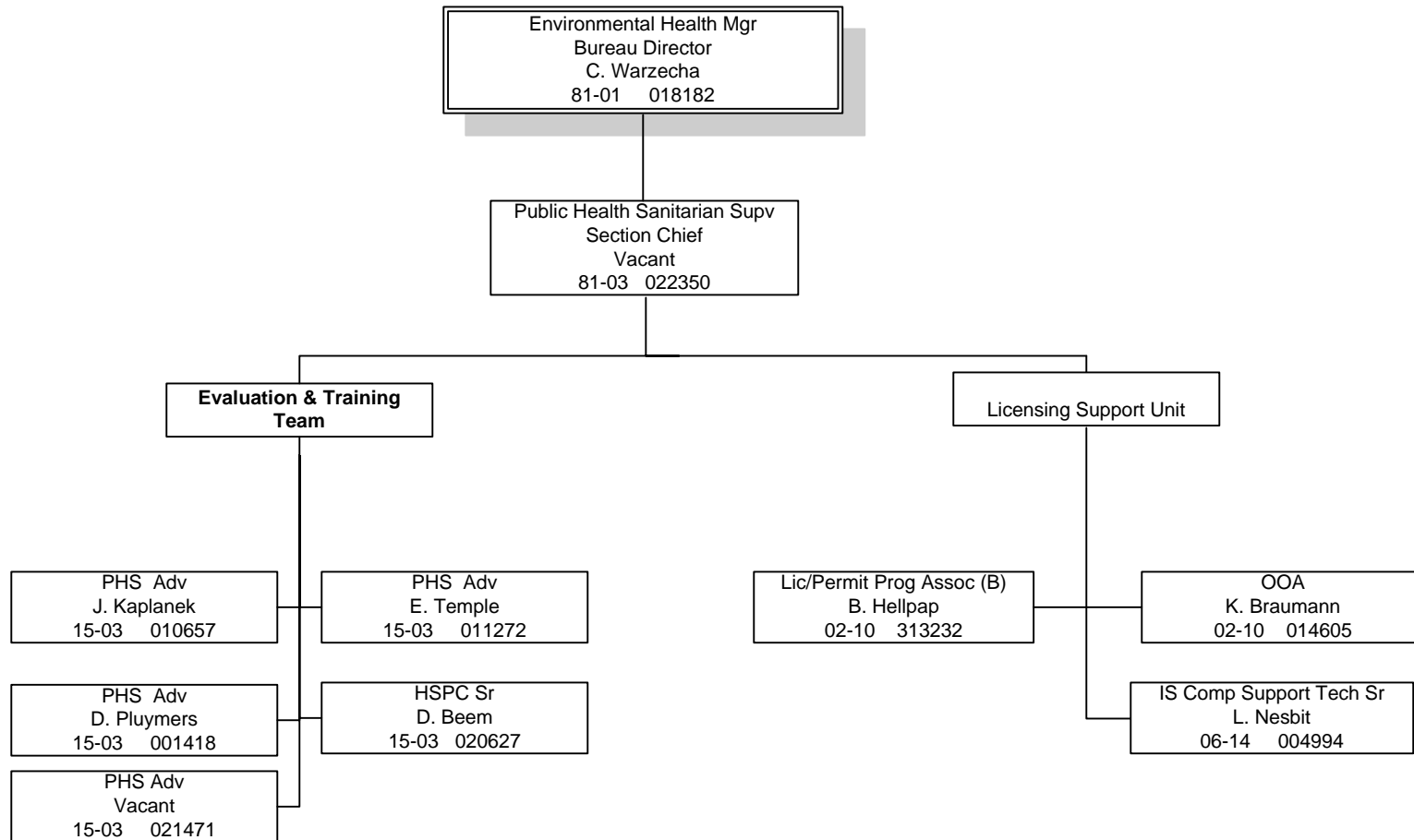

**Division of Public Health
Bureau of Environmental and Occupational Health
Health Hazard Evaluation Section**

March 2007

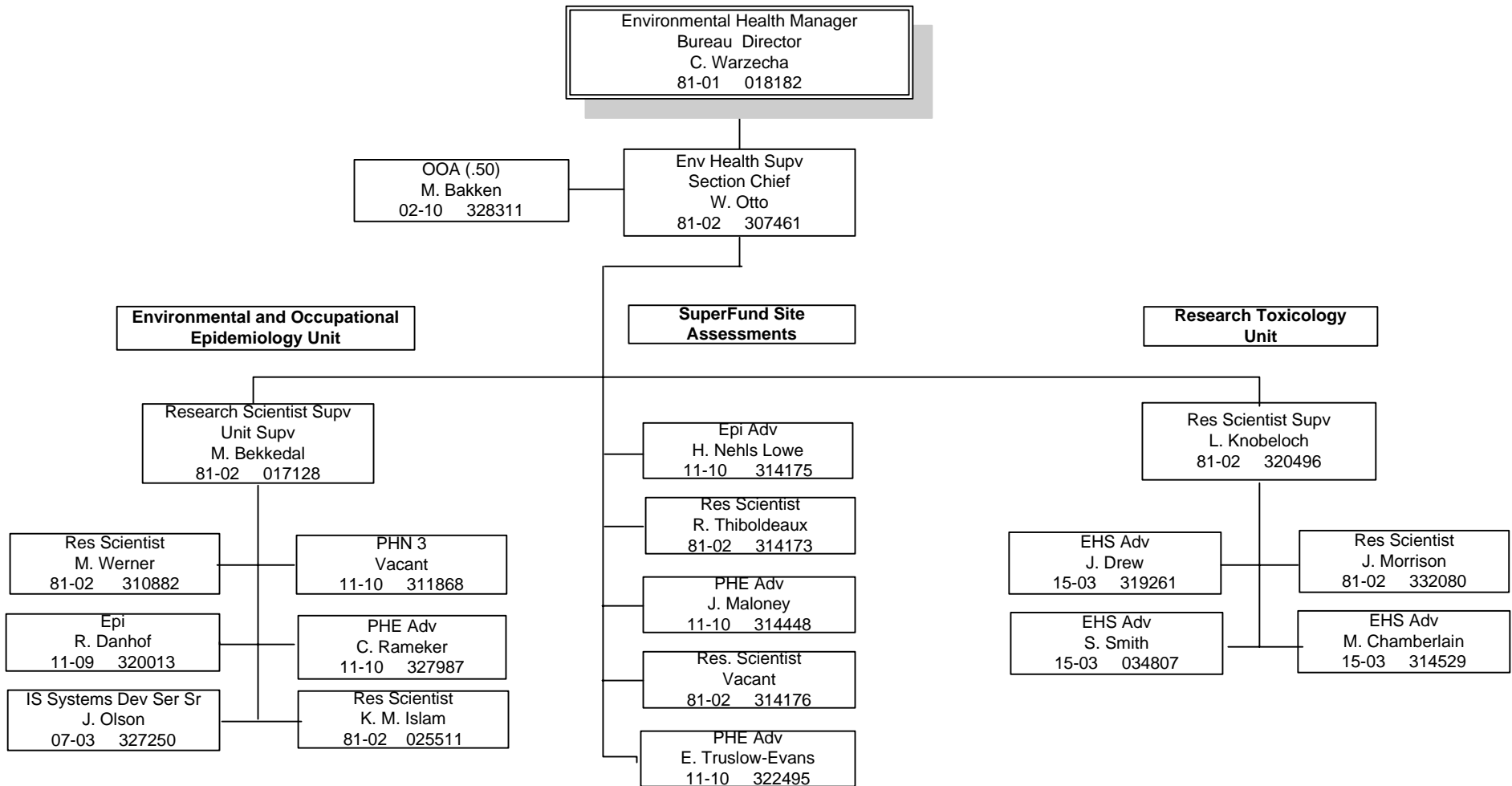

**Division of Public Health
Bureau of Environmental & Occupational Health
Asbestos & Lead(Pb) Section**

March 2007

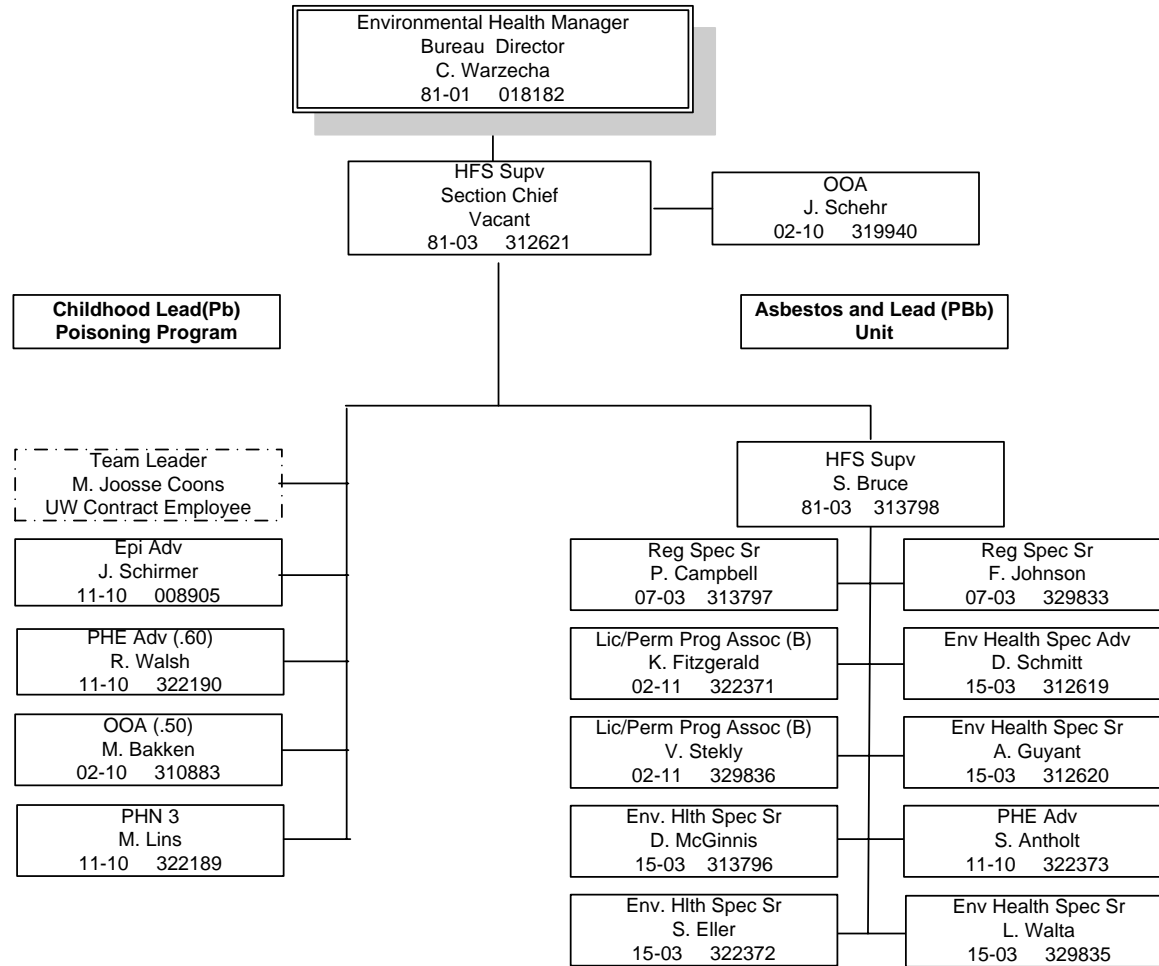

**Divison of Public Health
Bureau of Health Information and Policy
State Registrar / Vital Records Section**

March 2007

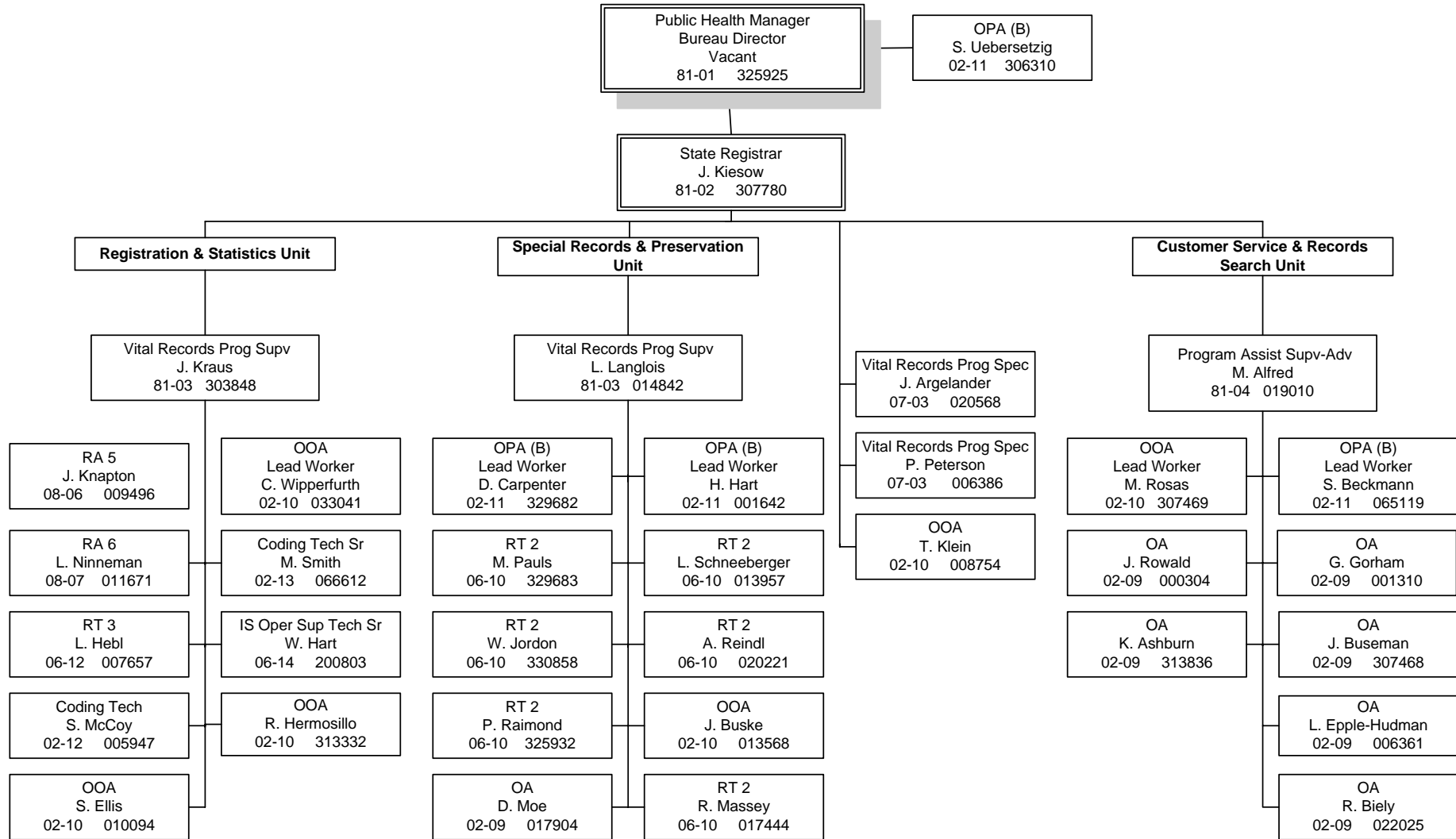

**Division of Public Health
Bureau of Health Information and Policy
Bureau Director's Office**

March 2007

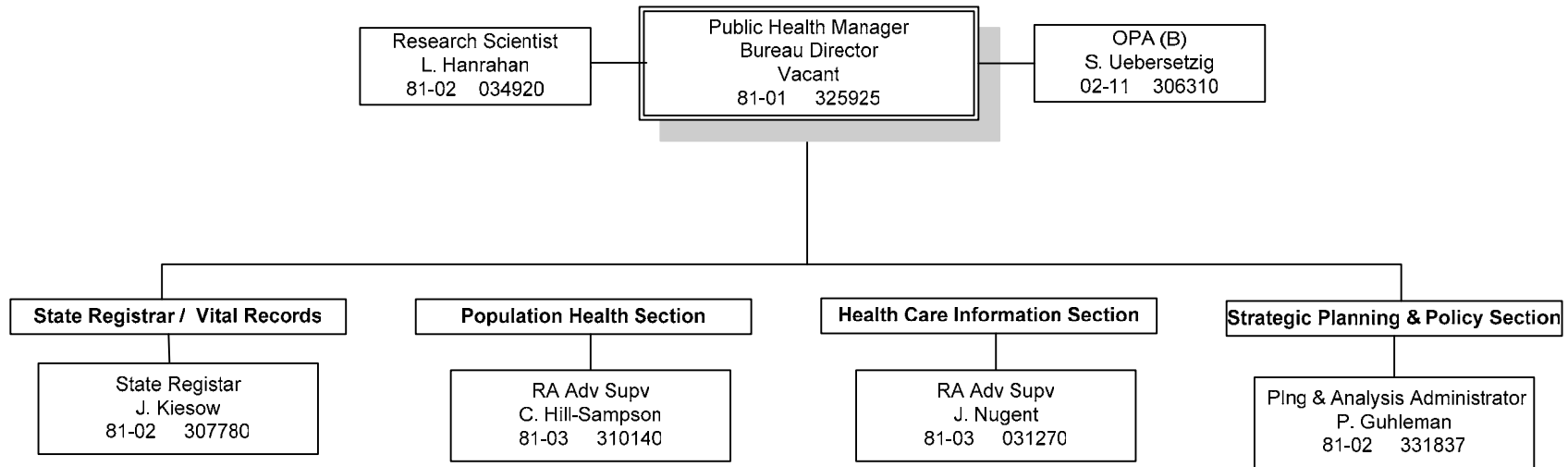

**Division of Public Health
Bureau of Health Information & Policy**

March 2007

Public Health Manager
Bureau Director
Vacant
81-01 325925

OPA (B)
S. Uebersetzig
02-11 306310

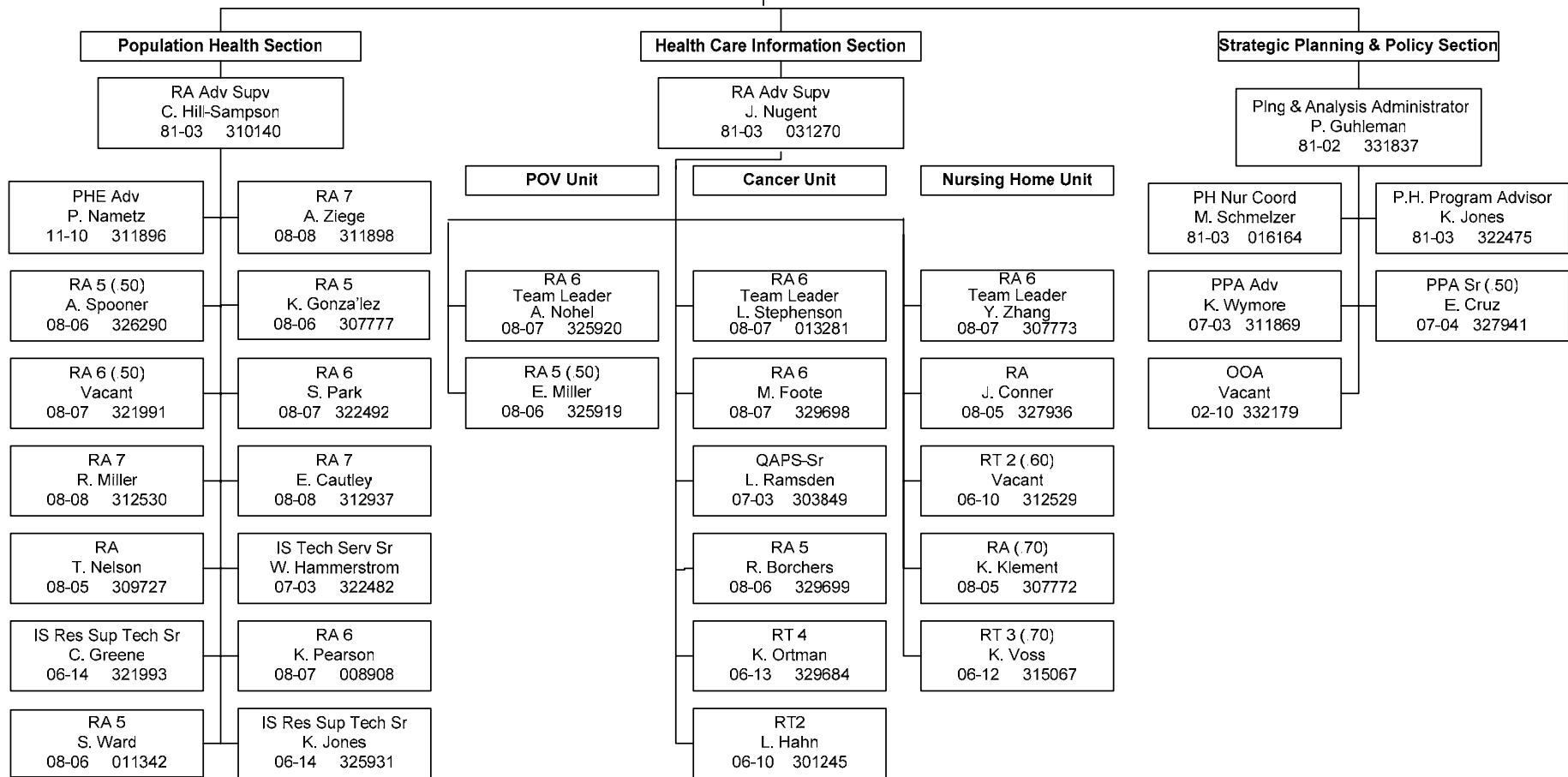

**Division of Public Health
Bureau of Local Health Support and Emergency Medical Services**

March 2007

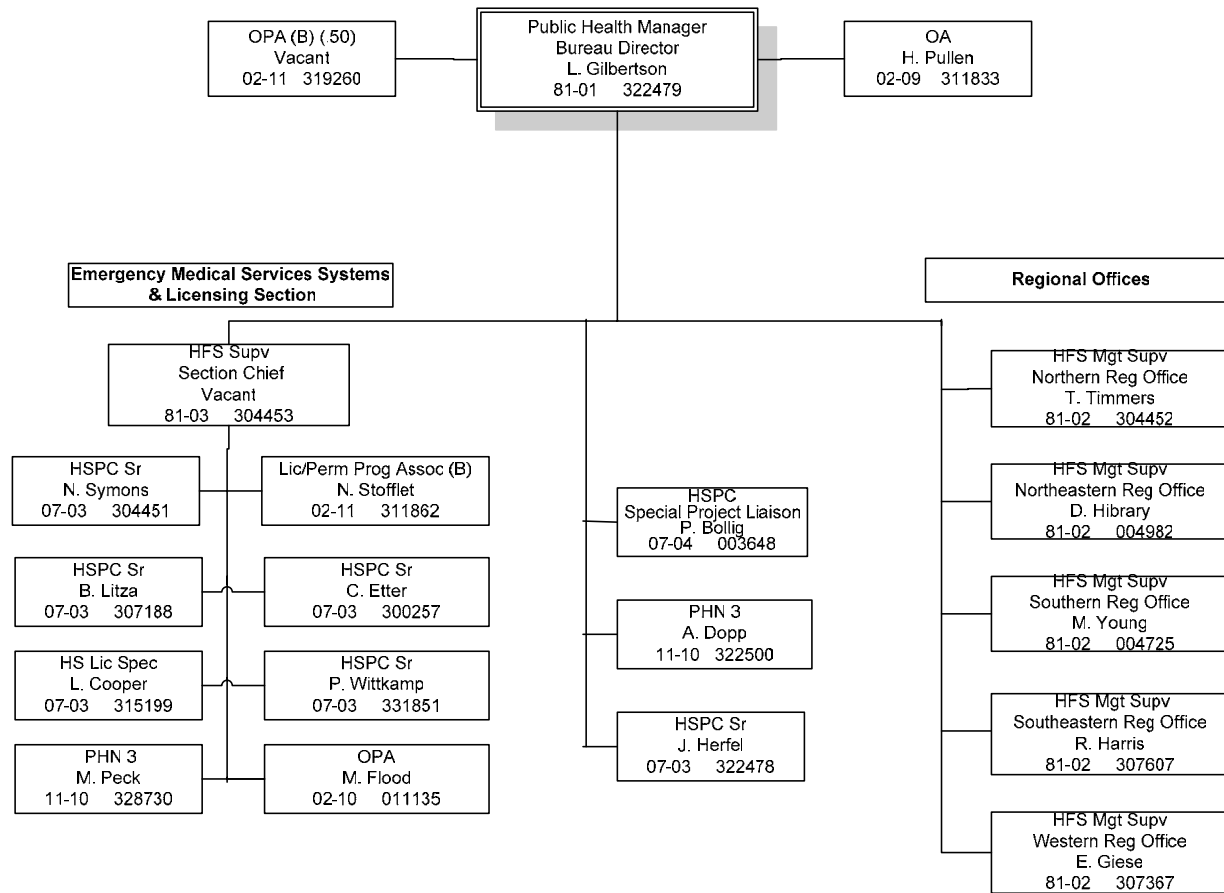

**Division of Public Health
Eau Claire Regional Office
(Western)**

March 2007

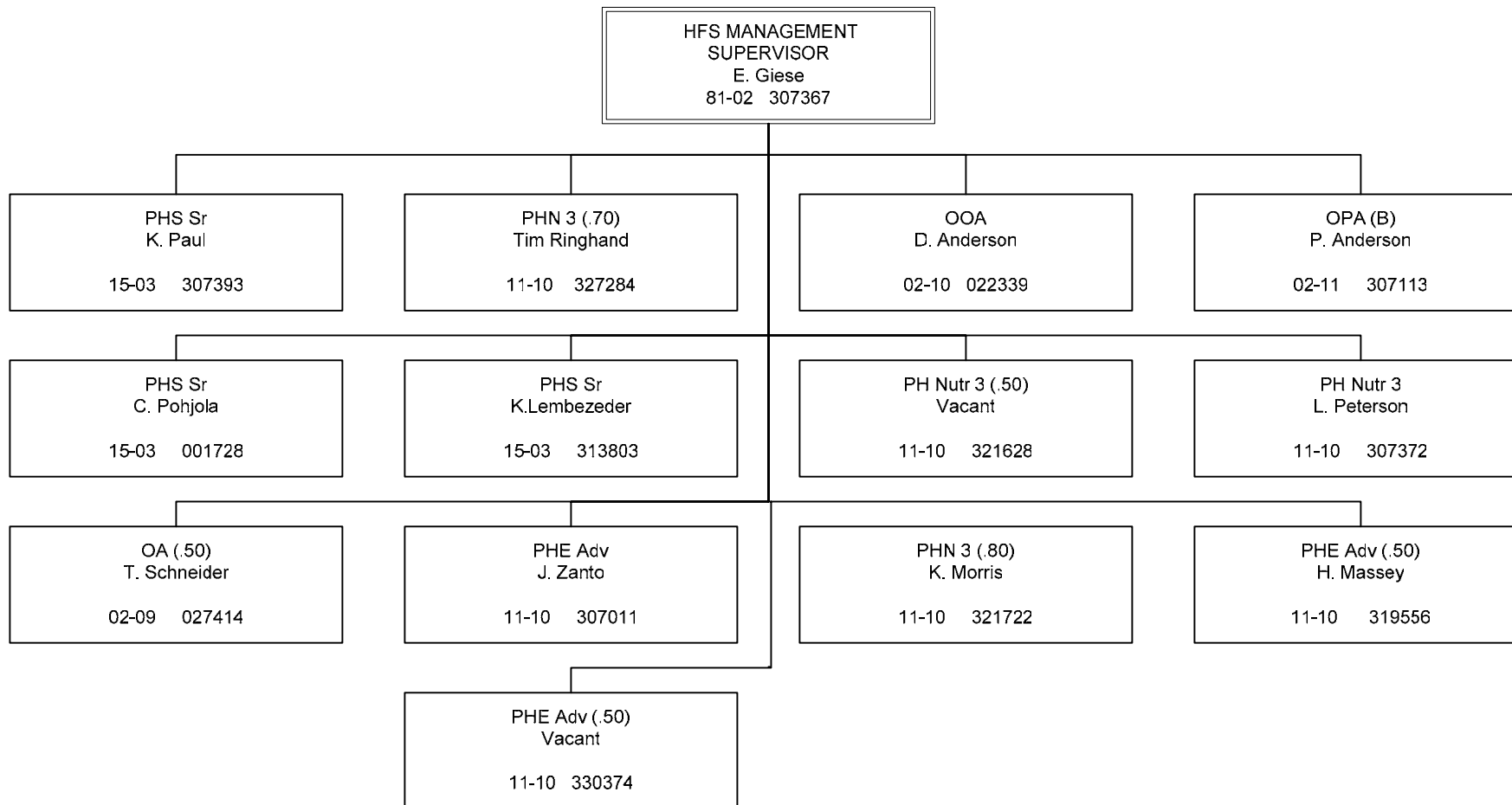

**Division of Public Health
Green Bay Regional Office
(Northeastern)**

March 2007

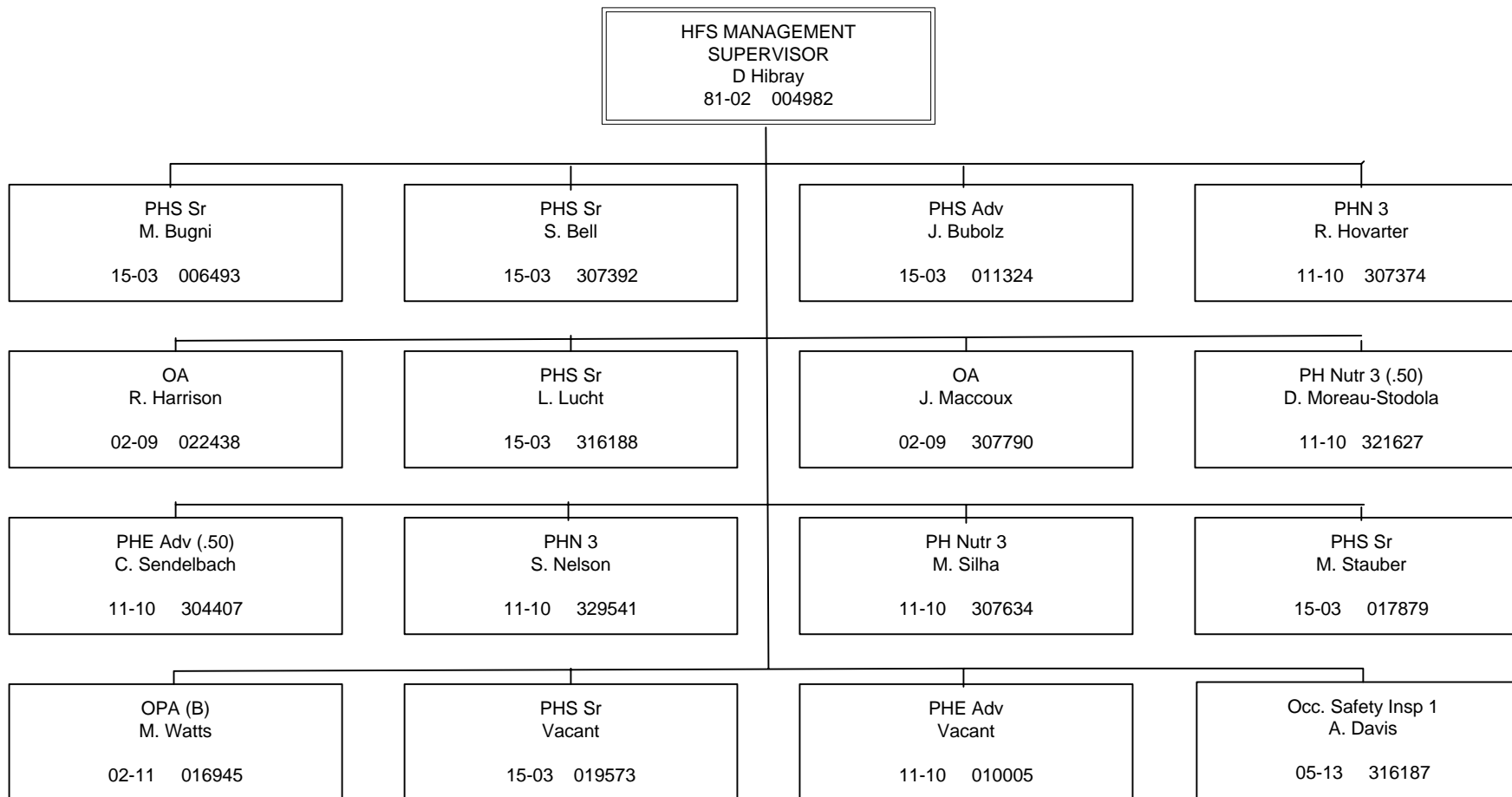

**Division of Public Health
Rhineland Regional Office
(Northern)**

March 2007

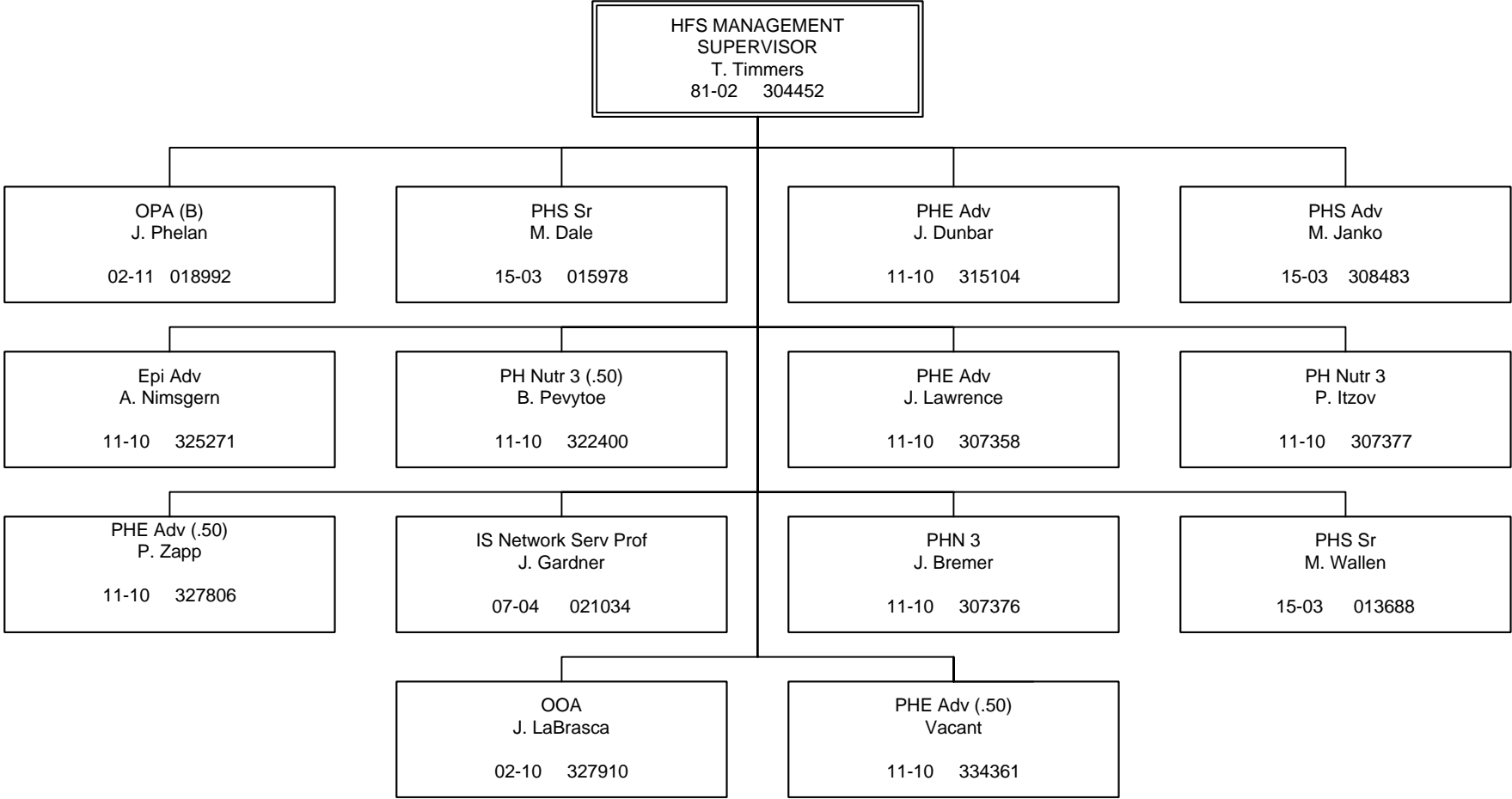

**Division of Public Health
Milwaukee Regional Office
(Southeastern)**

March 2007

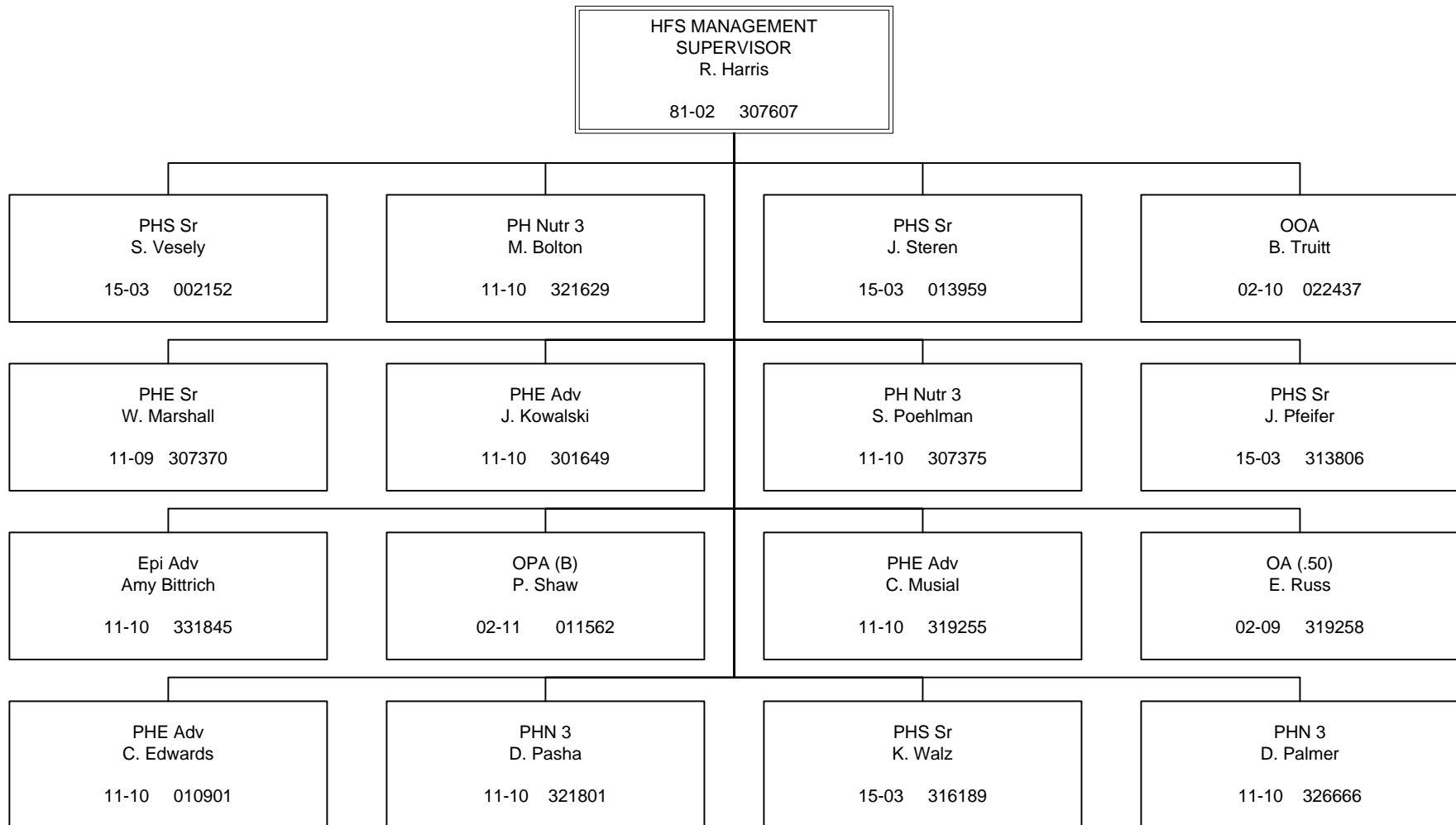

**Division of Public Health
Madison Regional Office
(Southern)**

March 2007

