

BC+ Handbook Release 16-01

Table Of Contents

Program Overview (Chapter 1)	1
1.1 BadgerCare Plus Introduction	1
1.1.1 Organization of the BadgerCare Plus Handbook.....	2
1.1.2 BadgerCare Plus Health Plan	2
1.1.3 Health Care Choice	3
1.1.4 How to Apply.....	4
Non-Financial Requirements (Chapters 2-15).....	5
2 BadgerCare Plus Group	5
2.1 BadgerCare Plus Non-Financial Program Requirements	5
2.2 Coverage Group Definitions	6
2.2.1 Parents	6
2.2.1.1 Paternity	6
2.2.1.2 Joint Placement.....	7
2.2.1.3 Dependent 18 Year Old	9
2.2.2 Caretaker Relative	9
2.2.3 Child Welfare Parents/Caretakers	10
2.2.4 Pregnant Woman.....	11
2.2.5 Former Foster Care Youth (Formerly Known as Youth Exiting Out of Home Care).....	11
2.2.6 Child	11
2.2.7 Childless Adults	11
2.3 BadgerCare Plus Test Group	12
2.3.1 The non-MAGI Test Group	12
2.3.1.1 Parents and Caretaker Relatives	13
2.3.1.2 Essential Person	14
2.3.1.3 Pregnant Women	15
2.3.1.4 Children.....	16
2.3.1.5 Childless Adults.....	16
2.3.2 MAGI Test Group.....	16
2.3.2.1 Forming the Test Group using MAGI Tax Filing Rules.....	17
2.3.2.2 Forming the Test Group Using MAGI Relationship Rules	18
2.3.2.3 MAGI Flowchart	18
2.3.3 Applying non-MAGI Rules vs. MAGI Rules.....	19
2.3.4 Former Foster Care Youth Eligibility	20
2.4 The BadgerCare Plus Household.....	21
2.4.1 Not Living in the Household.....	21
2.4.2 Temporary Absence	22
2.4.3 Students	22
2.5 BadgerCare Plus Assistance Groups	23
2.6 Participation Status Codes	25
2.7 BadgerCare Plus Group Examples.....	26
2.7.1 BadgerCare Plus Group Examples using non-MAGI Rules	26
2.7.2 BadgerCare Plus Group Examples using MAGI Rules	32
2.8 BadgerCare Plus Test Group Financial Rules	34

2.8.1 Non-MAGI Income Counting Rules 34

2.8.2 MAGI Income Counting Rules..... 35

3 Residence..... 37

3.1 Residence 37

3.2 Intent To Reside 38

3.3 Determining State Residency 39

 3.3.1 Under Age 21..... 39

 In an institution 39

 3.3.2 Age 21 and Over..... 39

3.4 Special Situations..... 40

 3.4.1 State Supplementary Payment 40

 3.4.2 IV-E Children 40

 3.4.3 Non IV-E Foster Children..... 41

 3.4.4 Homeless Persons..... 41

3.5 Absence From Wisconsin..... 41

 3.5.1 Temporary Absence 41

3.6 Inmates 42

 3.6.1 General BadgerCare Plus Application Process for Inmates of State Correctional Institutions 42

 3.6.2 BadgerCare Plus Application Process for Inmates with Multiple Inpatient Admissions 43

 3.6.3 Huber Law 44

4 Citizenship and Immigration Status 44

4.1 U.S. Citizens and Nationals..... 44

 4.1.1 Child Citizenship Act..... 45

 4.1.2 Compact of Free Association States..... 46

4.2 Documenting Citizenship and Identity 46

 4.2.1 Covered Programs..... 48

 4.2.1.1 Exempt Populations 48

 4.2.2 Reserved 49

 4.2.3 Reserved 49

 4.2.4 Hierarchy of Documentation 49

 4.2.5 Agencies Paying for Documentation 51

 4.2.6 Policy For Special Populations 51

 4.2.7 Situations Which Require Special Documentation Processing 54

 4.2.7.1 Person Add 54

 4.2.7.2 Presumptive Eligibility/Express Enrollment (EE) 54

 4.2.7.3 Individuals Without Verification and Affect on Household Eligibility 55

 4.2.7.4 Child Citizenship Act 2000 55

 4.2.7.5 Non-citizens 55

 4.2.7.6 Individuals in Institutional Care Facilities..... 56

4.3 Immigrants 56

 4.3.1 Public Charge 60

 4.3.2 Immigration and Naturalization Service Reporting..... 61

 4.3.3 Continuous Presence 61

 4.3.4 Immigration Status Chart 64

- 4.3.5 Iraqis and Afghans With Special Immigrant Status 66
 - 4.3.5.1 Counting Refugee-Related Income 67
 - 4.3.5.2 Refugee Medical Assistance 67
- 5 Medical Support and Third Party Liability 67
 - 5.1 Medical Support..... 67
 - 5.1.1 Recovery of Birth Costs..... 68
 - 5.1.2 Referral to CSA 68
 - 5.2 Medical Support / CSA Cooperation 70
 - 5.2.1 Introduction 70
 - 5.2.2 Failure to Cooperate 71
 - 5.3 Claiming Good Cause 72
 - 5.3.1 Claiming Good Cause Introduction 72
 - 5.3.2 Notice 72
 - 5.3.3 Good Cause Claim..... 73
 - 5.3.4 Circumstances 73
 - 5.3.5 Evidence 74
 - 5.3.6 Investigation..... 75
 - 5.3.7 Determination 76
 - 5.3.8 Good Cause Found 77
 - 5.3.9 Good Cause Not Found 77
 - 5.3.10 Review 77
 - 5.4 Cooperation Between IM & CSA..... 78
 - 5.4.1 Information 78
 - 5.4.2 BadgerCare Plus Discontinued 78
 - 5.4.3 Failure to Cooperate 78
 - 5.4.4 Fraud..... 79
 - 5.5 Third Party Liability 79
 - 5.5.1 TPL Cooperation 79
 - 5.5.2 TPL Cooperation Requirements..... 80
 - 5.5.3 TPL Good Cause Claim 80
 - 5.5.4 Assignment Process 80
 - 5.6 Casualty Claim Process (Subrogation)..... 81
 - 5.6.1 Reporting Accident or Injury Claims..... 81
 - 5.7 Other Health Insurance..... 82
 - 5.7.1 Policies Not to Report 82
- 6 Social Security Requirements..... 83
 - 6.1 SSN Requirements..... 83
- 7 Health Insurance Access and Coverage Requirements 84
 - 7.1 Health Insurance Conditions of Eligibility 84
 - 7.1.1 Health Insurance Conditions of Eligibility under Non-MAGI rules 84
 - 7.1.2 Health Insurance Conditions of Eligibility under MAGI rules 85
 - 7.2 Past Access to Health Insurance..... 86
 - 7.2.1 Introduction..... 87
 - 7.2.1.1 The 80 Percent Past Access Test..... 87
 - 7.2.1.2 The 9.5% Past Access Test 88
 - 7.2.2 Good Cause for 80% and 9.5% "Past Access Test" under Non-MAGI Rules... 89

7.2.3 Good Cause for the 80% "Past Access Test" Under MAGI Rules	89
7.3 Current Access to Health Insurance.....	90
7.3.1 Introduction.....	90
7.3.2 The 80 Percent Current Access Test.....	90
7.3.3.The 9.5 Percent Current Access Test.....	91
7.4 Current Health Insurance Coverage.....	92
7.4.1 Introduction.....	92
7.4.2 The 80% Coverage Test.....	93
7.4.3 The 9.5% Current Coverage Test.....	93
7.4.4 Current Coverage for BadgerCare Plus Prenatal Program.....	94
7.5 Reserved.....	94
7.6 Good Cause Reasons for dropping insurance coverage.....	94
7.7 Health Insurance Premium Payment (HIPP)	95
7.7.1 Introduction.....	96
7.7.2 Cost Effectiveness	96
7.7.3 Participation in HIPP	96
7.7.4 Cooperation	96
7.8 Access and Coverage Overview	97
7.8.1 Access and Coverage Overview Prior to January 31, 2014.....	97
7.8.2 Access and Coverage Overview for New Applicants on or After February 1, 2014.....	103
7.8.3 BadgerCare Plus Prenatal Program Insurance Access and Coverage Overview	106
8 Pregnant Women and Continuously Eligible Newborns.....	108
8.1 Pregnant Women	108
8.2 Continuously Eligible Newborns.....	109
9 Verification.....	110
9.1 Verification	110
9.2 Application	111
9.3 Eligibility Renewals	111
9.4 Changes	112
9.5 Documentation.....	112
9.6 Collateral contacts	113
9.6.1 Documenting Verbal Statements and Collateral Contacts	113
9.7 Release of information.....	114
9.8 General Rules.....	114
9.9 Mandatory Verification Items	116
9.9.1 Social Security Number.....	117
9.9.1.1 Newborns	118
9.9.1.2 BC + Emergency Services.....	118
9.9.1.3 BadgerCare Plus Prenatal Program	118
9.9.2 Immigrant Status	118
9.9.3 Pregnancy	118
9.9.4 Medical Expenses	119
9.9.5 Power of Attorney and Guardianship	119
9.9.6 Access to Employer-Sponsored Health Insurance	119

- 9.9.6.1 Employer Verification of Health Insurance (EVHI) Database..... 120
- 9.9.6.2 Other Forms of Health Insurance Access Verification 121
- 9.9.7 Tribal Membership 121
- 9.9.8 Pre-Tax Deductions 122
- 9.9.9 MAGI Tax Deductions 122
- 9.10 Questionable Items 122
 - 9.10.1 Front End Verification..... 123
- 9.11 Processing Time frame..... 123
 - 9.11.1 Verification Receipt Date..... 123
 - 9.11.2 Positive Actions..... 123
 - 9.11.3 Delay 123
 - 9.11.4 Negative Actions 124
- 9.12 Reasonable Compatibility for Health Care 124
 - 9.12.1 Programs for Which Reasonable Compatibility Will Apply 125
 - 9.12.2 Reasonable Compatibility Thresholds 126
 - 9.12.3 Reasonable Compatibility Test..... 127
 - 9.12.4 Determining a Data Exchange-Based Income Amount for the Reasonable Compatibility Test..... 129
 - 9.12.5 Use of Equifax Data for Verification of Income..... 130
- 10 Child Welfare Parents..... 132
- 10.1 Child Welfare Parent or Caretaker Relative 132
- 11 Foster Care Medicaid 134
- 11.1 Out-of-Home Care (Foster Care)..... 134
 - 11.1.1 Foster Care Medicaid Certification..... 135
 - 11.1.2 Foster Care Medicaid Disenrollment..... 135
- 11.2 Former Foster Care Youth 137
- 12 Migrant Workers 138
- 12.1 Migrant Workers 138
- 12.2 Migrant Worker Definition 138
- 12.3 Simplified Application..... 139
 - 12.3.1 Renewal dates for simplified application 140
- 12.4 Regular Application 140
 - 12.4.1 Renewals..... 141
- 13 - 15 Reserved 141
- Chapters 13-15 (Reserved)..... 141
- Financial Requirements (Chapters 16-24)..... 143
- 16 Income..... 143
- 16.1 Income 143
 - 16.1.1 Income Limits..... 143
 - 16.1.2 Income Under Non-MAGI Rules 144
 - 16.1.3 Income Under MAGI Rules..... 145
 - 16.1.4 Gap Filling..... 146
 - 16.1.4.1 Processing Application for Individuals Eligible Under Gap Filling Rules 146
 - 16.1.4.2 Processing Renewals for Individuals Eligible Under Gap Filling Rules .. 146
 - 16.1.4.3 Eligible Under Another Category of BadgerCare Plus or Medicaid 146
- 16.2 Income Types Not Counted 147

16.3 Income Deductions	161
16.3.1 Support Payments.....	161
16.3.2 Pre-Tax Deductions	162
16.3.3 Tax Deductions	162
16.4 Earned Income	165
16.4.1 Specially Treated Wages.....	166
16.4.2 Room and Board Income.....	168
16.4.3 Self-Employment Income.....	168
16.4.3.1 Income Sources	170
16.4.3.2 Calculating BadgerCare Plus Self-Employment Income	173
16.4.3.2.1 IRS Tax Forms	173
16.4.3.2.2 Worksheets.....	173
16.4.3.2.3 Disallowed Expenses.....	175
16.4.3.2.4 Anticipating Earnings.....	176
16.4.3.3 Losses Offsetting Other Income (MAGI Rules Only).....	178
16.4.4 Verification	178
16.4.4.1 Self-Employment Hours	178
16.5 Other Income	179
16.6 Fluctuating Income	185
16.7 Prorating Income	185
16.8 Migrant Worker's Income	186
17 Deductibles	186
17.1 Deductibles	187
17.2 Pregnant Women	187
17.2.1 Introduction.....	187
17.2.2 Deductible Period	188
17.2.3 Calculating the Deductible Amount.....	190
17.3 Children Under 19	191
17.3.1 Deductible Period	191
17.3.2 Calculating the Deductible Amount.....	192
17.4 Meeting The Deductible	193
17.4.1 When Expenses Can Be Counted Toward a Deductible	193
17.4.2 Countable Expenses.....	196
17.4.3 Expenses That Cannot Be Counted Toward a Deductible.....	198
17.5 Order of Bill Deduction	199
17.5.1 Hospital Bills	199
17.5.2 Pregnancy Fees.....	199
17.6 Prepaying a Deductible	200
17.6.1 Insufficient Funds.....	200
17.6.2 Payment of Entire Deductible Amount	200
17.6.3 Combination of Payment and Incurred Expenses.....	201
17.6.4 Combination of Payment and Outstanding Expenses.....	201
17.6.5 Calculation Errors	201
17.7 Remaining Deductible	202
17.8 Changes In Income	202
17.9 Non-financial Changes	204

17.9.1 Non-Financial Changes Introduction.....	204
17.9.2 Group Size Changes	204
17.9.3 Death	204
17.10 Late Reports of Changes	205
18 BC+ Extensions	205
18.1 BadgerCare Plus Extensions	205
18.1.1 BadgerCare Plus Extensions Introduction.....	205
18.1.2 Pregnant Women	207
18.1.3 Children.....	207
18.2 Increase in Earnings/Decrease in Group Size Extensions	209
18.2.1 Earned Income Extensions under Non-MAGI Rules	209
18.2.2 Earned Income Extensions under MAGI Rules	209
18.2.3 Supplemental Security Income Exception.....	210
18.3 Increase in Child Support or spousal Income Extensions	211
18.3.1 Support Extensions under Non-MAGI Rules.....	211
18.3.1.1 Four Month Extensions under Non-MAGI Rules.....	211
18.3.1.2 Twelve Month Extensions under Non-MAGI Rules.....	212
18.3.2 Support Extensions under MAGI Rules.....	212
18.3.2.1 Four Month Extensions under MAGI Rules	212
18.3.2.2 Twelve Month Extensions under MAGI Rules	213
18.4 Income Changes During The Extension.....	213
18.5 Losing an Extension	214
18.5.1 Introduction	214
18.5.2 Leaving Wisconsin	215
19 Premiums	215
19.1 BadgerCare Plus Premiums.....	216
19.2 Premium Calculations.....	218
19.2.1 Premium Calculations for Non-MAGI Households	218
19.2.2 Premium Calculations for MAGI Households	220
19.2.2.1 Children's Premiums using MAGI Rules.....	220
19.2.2.2 Adults' Premiums using MAGI Rules.....	220
19.3 Premium Limits	221
19.4 Premium Payment Methods.....	223
19.5 Initial Payments	223
19.6 On-going Payment.....	225
19.7 Advance Payments.....	226
19.7.1 Refunds.....	226
19.8 Non-Payment.....	226
19.8.1 Non-Payment Introduction.....	227
19.8.2 Insufficient Funds	227
19.8.3 Good Cause for Non-Payment.....	228
19.9 Late Payments.....	228
19.10 Premium Changes	229
19.10.1 Decreased premium amount.....	229
19.10.2 Increased premium amount.....	229
19.10.2.1 Person adds:	229

19.10.2.2 Effective dates of premium increase (Person Add).....	230
19.10.2.3 Effective dates of premium increase (other than person adds).....	230
19.11 BadgerCare Plus Restrictive Re-enrollment Period (RRP)	232
19.11.1 Restrictive Re-Enrollment Period (RRP) Introduction.....	232
19.11.2 Reapplying	234
20 Assets.....	235
20.1 Assets	235
21 - 24 Reserved	235
Chapter 21-24 (Reserved).....	235
Program Administration (Chapters 25-37).....	237
25 Application	237
25.1 Application.....	237
25.2 Application Types/Methods.....	238
25.3 Where to Apply	238
25.3.1 Where to Apply Introduction.....	238
25.3.2 Intercounty Placements.....	239
25.3.3 Applications Outside Wisconsin	239
25.3.4 Applications Received from the Federal Marketplace	240
25.4 Valid Application	240
25.5 Valid Signature	241
25.5.1 Witnessing the Signature	243
25.5.2 Telephone Signature Requirements.....	244
25.6 Filing Date.....	244
25.7 Timeframes.....	245
25.7.1 Timeframes Introduction.....	245
25.7.2 Changes.....	246
25.8 Begin Dates.....	247
25.8.1 Backdated Eligibility	247
25.8.1.1 BadgerCare Plus Family Planning Services	249
25.8.1.2 Pregnant Women.....	249
25.9 Denials and Terminations	250
25.9.1 Termination	250
25.9.2 Denial.....	250
26 Renewal.....	251
26.1 Renewals	251
26.1.1 Renewals Introduction.....	251
26.1.2 Three-Month Late Renewals	252
26.1.2.1 Verification Requirements for Late Renewals.....	253
26.1.2.2 Gaps in Coverage.....	253
26.1.3 Administrative Renewals.....	254
26.2 Choice of REnewal	256
26.3 Renewal Processing	257
27 Change Reporting.....	257
27.1 Changes Reported During the Application Processing Period	257
27.2 Non- financial Change Reporting Requirements	257
27.3 Income Change Reporting Requirements	258

27.4 Other Reported Changes	260
27.5 Change Reporting Requirements for BadgerCare Plus Family Planning ONLY	
Services Members:.....	260
28 Corrective Action	260
28.1 Overpayments.....	260
28.2 Recoverable Overpayments.....	261
28.3 Non-Recoverable Overpayments	264
28.4 Overpayment Calculation	264
28.4.1 Overpayment Period.....	264
28.4.2 Overpayment Amount.....	265
28.4.3 Overpayments for Individuals Eligible for Family Planning Only Services (FPOS)	266
28.4.4 Determining Liable Individual.....	266
28.5 Member Notice	267
28.6 Refer to District Attorney	267
28.7 Fair Hearing	268
28.8 Agency Retention	268
28.9 Restoration of Benefits	268
28.9.1 Premiums.....	268
29 Notices and Fair Hearings	269
29.1 Notices	269
29.2 Fair Hearings.....	270
30 Affirmative Action.....	270
30.1 Affirmative Action and Civil Rights.....	270
31 Interagency Transfer.....	271
31.1 Interagency Transfer	271
32 Presumptive Eligibility.....	271
32.1 Presumptive Eligibility (PE) for Children.....	271
32.1.1 Eligible Children for PE	272
32.1.2 Qualified Entities.....	272
32.2 Presumptive Eligibility (PE) for Pregnant Women	274
32.2.1 Eligible Pregnant Women for PE	274
32.2.2 Qualified Entities.....	275
32.3 Presumptive Eligibility for Adults	276
32.3.1 Eligible Adults for PE.....	276
32.3.2 Qualified Entities.....	277
32.4 At the IM Agency	277
32.5 Qualified hospitals for presumptive eligibility (PE).....	279
32.6 Express Enrollment process in ACCESS	280
33 Estate Recovery	280
33.1 Estate Recovery Program Definition	280
33.2 Recoverable Services	281
33.3 Estate Claims	282
33.3.1 Waiver of Estate Claim	283
33.3.2 Notice of Hardship Waiver Rights.....	284
33.3.3 Administrative Hearings: Hardship Waivers.....	284

33.3.4 Personal Representative’s Notice	285
33.3.5 Real Property as Part of the Estate	285
33.3.6 Affidavits in Small Sum Estates and Non-Probate Property	286
33.3.7 Patient Fund Account	287
33.3.8 Native Americans.....	288
33.3.9 Reparation Payments to Individuals	289
33.3.10 Voluntary Recovery (ERP).....	289
33.4 Match System.....	290
33.5 Notify Members	290
33.6 Disclosure Form	291
33.7 Estate Recovery Program (ERP).....	292
33.8 Incentive Payments	292
33.9 Other Programs.....	293
34-37 Reserved	293
Reserved.....	293
Program Coverage (Chapters 38-47)	295
38 Covered Services	295
38.1 Covered Services	295
38.2 Standard Plan.....	295
38.2.1 Introduction	295
38.2.2 Copayment	298
38.3 Transportation	300
38.3.1 Ambulance.....	301
38.3.2 Specialized Medical Vehicle (SMV)	301
38.3.3 Common Carrier	301
38.3.4 Transportation Coordination	301
38.4 HMO Enrollment.....	302
38.4.1 Change of Circumstances	303
38.4.2 Disenrollment.....	303
38.4.3 Fiscal Agent Ombuds	304
38.5 BadgerCare Plus Cards	304
38.5.1 BadgerCare Plus Cards Introduction	304
38.5.1.1 BadgerCare Plus & Medicaid Card Image.....	305
38.5.1.2 SeniorCare Card Image	305
38.5.1.3 Wisconsin Well Woman Program Card Image	306
38.5.2 Appeals.....	307
38.5.3 Homeless.....	307
38.5.4 Pharmacy Services Lock-in Program.....	308
38.5.5 Temporary Cards	308
38.5.6. Lost-Stolen Cards	308
38.6 Good Faith Claims.....	309
38.6.1 Definition of Good Faith Claims	309
38.6.2 Denials.....	309
38.6.3 Causes and Resolutions.....	310
38.6.4 Process.....	311
38.6.5 Instructions	311

38.7 Impact on Dual Eligible Individuals.....	313
39 Emergency Services.....	314
39.1 Emergency Services Income Limits	314
39.2 Determining if an emergency exists	316
39.2.1 Determining Eligibility	317
39.2.2 Providing Manual Positive or Negative Notice	318
39.3 Emergency Services For Pregnant Women	318
39.4 Newborns	320
39.5 Eligibility Begin Date for non-qualifying immigrants who lose eligibility for the BadgerCare Plus Prenatal Program.....	320
39.6 BadgerCare Plus Deductible	321
40 Family Planning Only Services (FPOS).....	321
40.1 Family Planning Only Services Program.....	321
40.2 FPOS Presumptive Eligibility (PE).....	322
40.2.1 Introduction	322
40.2.2 Qualified Entities	323
40.2.3 IM Agency	324
40.2.4 Express Enrollment Process in ACCESS.....	325
40.3 FPOS Application.....	325
40.4 FPOS Non-financial Requirements	325
40.5 FPOS FINANCIAL Requirements.....	326
40.5.1 Financial Eligibility Requirements Specific to FPOS	327
40.5.2 Income Under MAGI Rules	327
40.6 FPOS Group.....	327
40.6.1 Fetus	327
40.6.2 Children 18 years of Age.....	328
40.6.3 FPOS Group under MAGI Rules	328
40.6.4 Transitioning to MAGI Rules	328
40.7 FPOS Program Choice.....	328
40.8 FPOS Changes	329
40.9 FPOS BadgerCare Plus Extension Phase	330
40.10 FPOS Reviews and Recertifications.....	331
40.11 FPOS Confidentiality	331
41 BadgerCare Plus Prenatal Program	332
41.1 BadgerCare Plus Prenatal Program.....	332
41.2 BadgerCare Plus Prenatal Program Eligibility Requirements.....	333
41.2.1 Unique Aspects of BadgerCare Plus Prenatal Program.....	333
41.3 BadgerCare Plus Prenatal Policy for Non-qualifying Immigrants	334
41.4 BadgerCare Plus Prenatal Program Policy For Inmates	334
41.5 BadgerCare Plus Prenatal Program Eligibility Begin Date	335
41.6 BadgerCare Plus Prenatal Eligibility End Date.....	335
41.7 Determining BadgerCare Plus Prenatal Group	336
41.7.1 The BadgerCare Plus Prenatal Group through January 31, 2014.....	336
41.7.2 The BadgerCare Plus Prenatal Group After February 1, 2014.....	337
41.8 BadgerCare Plus Prenatal Program Benefit Information	337
42 Long-term Care for Childless Adults	337

42.0 long-term care for childless adults..... 338

 42.1 Long-term Care Eligibility Requirements for Childless Adults Eligible for
 BadgerCare Plus 338

42.2 Patient Liability, Estate Recovery, and Other Policies for Childless Adults Eligible
for BadgerCare Plus While in Long-term Care 339

42.3 Institutionalized Individuals Determined Eligible for Elderly, Blind, or Disabled
Medicaid..... 339

 43 BadgerCare Plus Core Plan 340

43.1 BadgerCare Plus CORE PLAN 340

 44 Reserved 340

ReSERVED..... 340

 45 BC+ Basic Plan..... 341

45.1 BadgerCare Plus Basic Plan 341

 46-47 Reserved 341

Reserved..... 341

Tables (Chapters 48-52) 343

 48 Premiums 343

48.1 BadgerCare Plus Premium Tables..... 343

 48.1.1 Premiums for Children 343

 48.1.2 Premiums for Adults 343

 48.1.3 Premiums for Adult Caretaker Families with Self-Employment Income 354

 49 Health Care Choice 355

49.1 Health Care Choice..... 355

 50 Federal Poverty Level Table..... 356

50.1 Federal Poverty Level Table 356

 51 BadgerCare Plus Medical Status Codes..... 357

51.1 BadgerCare Plus Medical Status Codes 357

 52 Core Plan Health Insurance..... 361

52.1 CORE PLAN HEALTH INSURANCE 361

PROGRAM OVERVIEW (CHAPTER 1)

[View History](#)

1.1 BADGERCARE PLUS INTRODUCTION

BadgerCare Plus is a state/federal program that provides health coverage for Wisconsin families and individuals living in poverty. BadgerCare Plus replaced the former AFDC-Medicaid, Healthy Start, and BadgerCare programs.

Potential BadgerCare Plus members will include:

- Children under 19 years of age,
- Pregnant women,
- Parents and caretakers of children under 18 and dependent 18 year olds,
- Parents and caretaker relatives whose children have been removed from the home and placed in out of home care,
- Former foster care youth under age 26 who were in out-of-home care when they turned 18, and
- Effective April 1, 2014, adults ages 19-64 who are not receiving Medicare and do not have dependent children.

For information on income limits, see [Section 16.1 Income](#) and [Section 50.1 Federal Poverty Level Table](#). A person is eligible for BadgerCare Plus if he or she meets all BadgerCare Plus non-financial and financial requirements.

Documented and undocumented immigrants who are children, parents, or caretakers and who are ineligible for BadgerCare Plus solely due to their immigration status may be eligible for coverage for BadgerCare Plus Emergency Services.

Documented and undocumented immigrants who are pregnant and ineligible for BadgerCare Plus solely due to their *immigration status* may be eligible for the BadgerCare Plus Prenatal Program.

Women and men 15 years of age or older may be eligible for limited benefits under the BadgerCare Plus Family Planning Only Services program.

Women ages 35-65 diagnosed with cervical or breast cancer may be eligible for Well Woman Medicaid. See the [Medicaid Eligibility Handbook](#) for more information on Well Woman Medicaid.

Individuals who are elderly, blind or disabled may be eligible for Medicaid. Medicaid is a state/federal program that provides health coverage for Wisconsin residents that are

EBD. Medicaid is also known as Medical Assistance, MA, and Title 19. There are different subprograms of Medicaid:

- *SSI*-related Medicaid
- *MAPP*
- Institutional Long Term Care
- Home and Community Based Waivers Long Term Care
- Family Care Long Term Care
- Partnership Long Term Care
- *PACE*: Anyone age 65 or older
- Katie Beckett
- Tuberculosis-related Medicaid
- Medicare Premium Assistance: *QMB, SLMB, SLMB+, QDWI*
- Emergency Medicaid
- SeniorCare

See the [Medicaid Handbook](#) for more information about these subprograms.

1.1.1 Organization of the BadgerCare Plus Handbook

This handbook outlines eligibility policy for Wisconsin's BadgerCare Plus program. This version documents multiple policy changes that will affect the BadgerCare Plus program in 2014 as a result of changes in state law and the federal Affordable Care Act. Accordingly, this handbook contains policy for the BadgerCare Plus program that is currently in effect and policy that will take effect in 2014. Policy that is time-limited or time-dependent will be modified with the appropriate effective date. Policy that is not identified as having an effective or end date is currently in place and will continue to exist in 2014.

Beginning in 2014, the BadgerCare Plus program will use a different set of eligibility rules to determine household size and countable income. This version of the handbook addresses two forms of budgeting rules. More information about these budgeting methodologies is found in [Chapter 2 BadgerCare Plus Group](#). The new budgeting rules that will be applied to applicants and members in 2014 will be referred to as *MAGI* rules. The rules currently in place for BadgerCare Plus will be referred to as *non-MAGI* rules.

1.1.2 BadgerCare Plus Health Plan

The Standard Plan is for adults, parents, or caretakers with household income at or below 100 percent of the *FPL* and children and pregnant women with income at or below 300 percent of the FPL (see [Section 50.1 Federal Poverty Level Table](#) for FPL limits).

BadgerCare Plus has several limited health plans. These include:

- Family Planning Only Services

- BadgerCare Plus Prenatal Program, and
- BadgerCare Plus Emergency Services

Standard plan members may be asked to pay a share of the cost of services. The copayment amount ranges from \$.50-\$3.00 per service.

Beginning February 1, 2014, all new applicants found eligible for BadgerCare Plus will be covered under the Standard Plan. Beginning April 1, 2014, all BadgerCare Plus members, regardless of when they applied, will receive coverage under the Standard Plan.

1.1.3 Health Care Choice

It is possible for individuals to qualify for both BadgerCare Plus and EBD Medicaid based on financial and non-financial eligibility criteria.

When a person is eligible for both BadgerCare Plus and EBD Medicaid, different rules apply based on whether the BadgerCare Plus eligibility is determined under non-MAGI or MAGI rules.

When eligibility is determined for such an individual under non-MAGI rules, **CARES** will automatically enroll the individual in the program with the best benefit plan and lowest cost share. The individual has the right to request coverage under the program not chosen by CARES (see [Section 49.1 Health Plan Choice](#)). The change will be effective in the next possible payment following **Adverse Action**, unless the member requests the change be effective in the month the request to change the health plan was made.

If CARES is unable to make an automatic choice between BadgerCare Plus and EBD Medicaid, a notice requesting the individual make a choice will be generated. Once the member has made a choice, the decision remains in effect until:

- The member requests a change, or
- The member's benefit under the health plan of his or her choice ends.
(This includes being placed into an unmet **deductible AG**.)

When eligibility is determined for such an individual under MAGI rules, federal law requires that once an individual has been determined eligible for EBD Medicaid, he or she must be enrolled in EBD Medicaid, even if they are also eligible for BadgerCare Plus, unless they have a change in circumstances that results in ineligibility for EBD Medicaid. The only exception to this policy is pregnant women who are eligible for both EBD Medicaid and BadgerCare Plus. In these instances, the pregnant woman will be enrolled in the BadgerCare Plus program.

If someone is pending for EBD Medicaid or if they have an unmet deductible for EBD Medicaid, the individual is not considered eligible for EBD Medicaid and can enroll in BadgerCare Plus. Pending for EBD Medicaid includes, but is not limited to, waiting for

an official disability determination from DDB. If an individual enrolled in EBD Medicaid is determined ineligible for EBD Medicaid for any reason, including going over the asset limit or failing to pay a MAPP premium, he or she can enroll in BadgerCare Plus if he or she is still eligible to do so.

1.1.4 How to Apply

The following *application* options are available for anyone who is applying for BadgerCare Plus:

1. ACCESS online application at <https://access.wisconsin.gov/>
2. Face-to-face interview at the local county/tribal office
3. Paper application
4. Telephone interview
5. An application submitted to the *Federally Facilitated Marketplace*.

Click here to view the [directory](#) of local county/tribal agencies in Wisconsin or call 1-800-362-3002.

*This page last updated in Release Number: 14-02
Release Date: 05/14/14
Effective Date: 04/01/14*

NON-FINANCIAL REQUIREMENTS (CHAPTERS 2-15)

2 BadgerCare Plus Group

[View History](#)

2.1 BADGERCARE PLUS NON-FINANCIAL PROGRAM REQUIREMENTS

The following individuals are non-financially eligible for BadgerCare Plus:

1. Children under 19,
2. Pregnant Women,
3. Parents/caretaker relatives of children under 18 years of age or dependent 18 year olds, including some parents and caretaker relatives whose children have been removed from the home and are in the care of the child welfare system (see [Chapter 10 Child Welfare Parents](#)), and
4. Former foster care youth under age 26 who were in out-of-home care when they turned 18, and
5. Effective April 1, 2014, adults ages 19-64, not receiving Medicare, who do not meet any of the conditions listed above.

To meet conditions of eligibility, the *applicant* must:

1. Be a Wisconsin resident (see [Chapter 3 Residence](#)),
2. Be a U.S. citizen or qualified immigrant (see [Chapter 4 Citizen and Immigration Status](#)),

Note: This is not a requirement for non qualifying immigrants receiving Emergency Services (see [Chapter 39 Emergency Services](#)) or women applying for the BadgerCare Plus Prenatal Program (see [Chapter 41 BadgerCare Plus Prenatal Program](#)).

3. Provide documentation of citizenship and identity or *immigration status* (see [Section 4.1 U.S. Citizens and Nationals](#)),
4. Cooperate with establishing medical support and *TPL* (see [Chapter 5 Medical Support and Third Party Liability](#)),
5. Sign over to the state his or her rights to payments from a third party for medical expenses (see [Section 5.2 Medical Support/CSA Cooperation](#)),
6. Meet BadgerCare Plus *SSN* requirements (see [Chapter 6 Social Security Requirements](#)),
7. Cooperate with verification requests when information is mandatory or deemed questionable (see [Chapter 9 Verification](#)),

8. Meet health insurance access and coverage requirements (see [Chapter 7 Health Insurance Access and Coverage Requirements](#)).

*This page last updated in Release Number: 14-01
Release Date: 02/07/14
Effective Date: 02/01/14*

[View History](#)

2.2 COVERAGE GROUP DEFINITIONS

[2.2.1 Parents](#)

[2.2.1.1 Paternity](#)

[2.2.1.2 Joint Placement](#)

[2.2.1.3 Dependent 18 Year Old](#)

[2.2.2 Caretaker Relative](#)

[2.2.3 Child Welfare/Caretakers](#)

[2.2.4 Pregnant Woman](#)

[2.2.5 Former Foster Care Youth \(Formerly Known as Youth Exiting Out of Home Care\)](#)

[2.2.6 Child](#)

[2.2.7 Childless Adults](#)

The following are the relationships and legal responsibility which determine who is in the BadgerCare Plus coverage groups:

2.2.1 Parents

A parent is any natural, legally adoptive, or stepmother or stepfather. A parent can be any age. There can be more than one parent of a certain gender in a household. To be considered a parent of a child under age 19 for BadgerCare Plus purposes, the child must be under the care of that individual at least 40 percent of the time. For example, in families where parents are divorced, if the child does not live with Parent B at least 40 percent of the time, Parent B would have his or her eligibility considered under the Childless Adults coverage group, rather than the Parents/Caretakers coverage group.

Note: A child under age 19 residing with a parent may not apply separately from his or her parent. In addition, the parent must apply as the primary person for the case, unless the child filing the application is 18 years old.

2.2.1.1 Paternity

When a woman is married at the time that she gives birth, her husband is considered the legal father of the child unless a court later determines that someone else is the father.

If the parents of the child are not married at the time of the child's birth, paternity must be established in order to determine the parental relationship for the father. Paternity is legally established only by a court order or by a Voluntary Paternity Acknowledgment form (DPH 5024) signed on or after May 1, 1998, and filed with the state Vital Records office. A father's name on a birth certificate issued in Wisconsin on or after May 1, 1998, is evidence that paternity has been established.

The following designations for a father are used in **CARES**. See the accompanying definitions to determine which designation is appropriate for a case.

1. Claimed father

A claimed father is someone claiming to be the father of a child but has not had his paternity established. **A claimed father is not the father for BadgerCare Plus eligibility purposes.** His child should be referred to the **CSA** so that steps to establish paternity can be taken.

2. Acknowledged father

An acknowledged father is someone who has not had his paternity adjudicated by a court, but has filed a formal paternity claim. An acknowledged father is one who fits one of the following criteria:

- a. Filed paternity papers prior to May 1, 1998
- b. Has his name on the birth certificate and the certificate is from another state or from Wisconsin and for a birth prior to May 1, 1998.

An acknowledged father is considered to be a parent for BadgerCare Plus eligibility purposes. However, because there is still no evidence of a formal adjudication, refer acknowledged fathers to the CSA so that steps to establish paternity may be taken.

3. Legal/adjudicated father

A father who has had his paternity legally established is called the adjudicated father. Paternity is legally established by either a court order (adjudication) or by a Voluntary Paternity Acknowledgment form signed by the father on or after May 1, 1998, that is filed with the Wisconsin Vital Records office.

Note: If a father's name appears on a Wisconsin birth certificate for a child born after May 1, 1998, it means paternity has been established. Do not refer adjudicated fathers to the CSA.

2.2.1.2 Joint Placement

2.2 Coverage Group Definitions

When the natural or adoptive parents of a child do not live together and have joint placement arrangements for the child (through a mutually agreed upon arrangement or court order), only one parent can be determined eligible at a time unless there is reasonably equivalent placement. Reasonably equivalent placement means that the child is residing with each parent at least 40 percent of the time during a month.

If the child is not residing with both parents at least 40 percent of the time, only the parent with the greater percentage of the placement time may apply on behalf of the child and/or for himself or herself as the caretaker relative of that child.

If only one parent of a child is applying for BadgerCare Plus and he or she is stating that he or she has placement of the child for at least 40 percent of the time, accept the declaration unless it is questionable.

If both parents are applying for BadgerCare Plus and claim the child is residing with them, act on their BadgerCare Plus cases as follows:

1. If both parents agree that they have a reasonably equivalent placement arrangement, ask under which parent's case they want the child to be receiving BadgerCare Plus benefits and determine eligibility for both parents' cases.
2. If either parent disputes that the placement arrangement is reasonably equivalent, the eligibility worker must determine the monthly percentage of the physical placement based on the court order. If the court order does not show reasonably equivalent placement, consider the child to be with the parent he or she is residing with during the month in question and deny the other parent's eligibility as a caretaker relative of this child.
3. If the parents cannot agree on which case the child will receive benefits, put the child on the case with the family whose income is at the lower *FPL* level.
4. Document your decision in the case record.

In determining eligibility for the parents with equivalent placement, the child is considered to be residing in both of their homes. That means the child will be included in the group size for both cases and the child's income will also be counted in both cases.

If reasonably equivalent placement exists (as described above) and both parents apply for BadgerCare Plus for the child and the child has access to health insurance where an employer pays 80 percent or more of the monthly premium in one home but not the other, the child shall remain eligible for BadgerCare Plus on the case with the parent who does not have access to health insurance for which the employer pays 80 percent or more.

Example 1: Johnny, age 10, lives 50 percent of the time with his mom and 50 percent of the time with his dad. Both Johnny's dad and mom have applied for BadgerCare Plus. Mom is employed, but does not have access to health insurance

coverage through her employer. Dad is employed and does have access to a family health insurance where his employer pays 81 percent of the monthly premium. Johnny can remain eligible on his mom's case.

If reasonably equivalent joint placement exists and both parents apply for BadgerCare Plus for the child and the income of either case requires that a premium be paid as condition of the child's BadgerCare Plus eligibility, then the parents can choose in which case the child will receive BadgerCare Plus coverage. A premium requirement in one case does not preclude eligibility in the other parent's case where no premium for the child would be owed.

Example 2: Billy, age 8, lives 40 percent of the time with his dad and 60 percent of the time with his mom. Both parents are applying for BadgerCare Plus. In his mother's case, the family income is 220 percent FPL and in his dad's case, the family income is 180 percent FPL. Billy's parents decide that Billy will be receiving his BadgerCare Plus coverage through Dad's case.

If joint placement exists with a parent who lives in another state, the child must be with the Wisconsin parent at least 50 percent of the time in a month to qualify for BadgerCare Plus.

2.2.1.3 Dependent 18 Year Old

Effective February 1, 2014, when an adult is eligible as a parent or caretaker because they are caring for an 18-year-old child, and that child is the only child in the home, the child must meet both the following conditions in order for the parent or caretaker to be eligible for BadgerCare Plus as a parent or caretaker of a dependent 18 year old:

- Be enrolled in high school
- Be expected to graduate high school before turning 19.

The child does not have to be enrolled full time in high school in order to meet this definition of dependent child.

The 18 year old remains eligible as a child until he or she turns 19, regardless of school enrollment or expected date of graduation.

2.2.2 Caretaker Relative

A caretaker relative is a non-legally responsible relative of the child under his or her care. Caretaker relatives and their spouses can be eligible for BadgerCare Plus as caretaker relatives. To be considered a caretaker relative of a child in the home, a person must first have a qualifying relationship to the child (under age 19) and the child must also be under the care of that relative.

Qualifying relationships for caretaker relatives consist of the following:

1. Stepfather or stepmother (when the parent is deceased or divorced/separated from the stepparent).
2. Natural full brother or sister, legally adopted, half- or stepbrother or sister.
3. Grandmother or grandfather, aunt or uncle, first cousin, nephew or niece, or any preceding generation denoted by the prefix grand-, great-, or great-great, and including those through adoption.
4. Spouse of any of the above and the spouse of a child's parent, even after the marriage ends by death, divorce, or separation.

Annulment of a marriage removes all relationships established by the marriage except parent.

A spouse is that person recognized by Wisconsin law as another person's legal husband or wife. Wisconsin does not recognize common law marriage.

Being "under the care" means the caretaker exercises primary responsibility for the child's care and control, including making plans for him or her. Once a child marries, he or she can no longer be considered under the care of a caretaker relative.

In cases where a child resides with both a caretaker relative and a parent, the parent is considered the caretaker relative, unless legal custody has been given by a court to the caretaker relative. In that situation, the caretaker relative is considered the caretaker relative of that child and could be eligible for BadgerCare Plus.

Note: A child under age 19 residing with a caretaker relative may not apply as the primary person for the relative's benefits. For both a caretaker relative and a child to be included in one case, the caretaker relative must apply for BadgerCare Plus.

2.2.3 Child Welfare Parents/Caretakers

For individuals whose eligibility is being determined under *non-MAGI* rules
Parents and caretaker relatives whose children have been placed in out of home care and who meet the criteria listed in [Chapter 10 Child Welfare Parents](#) are still considered caretaker relatives of the child. The child is considered temporarily absent from the home. The child(ren) is included in the BadgerCare Plus test group and any unearned income the child has is budgeted. However, unlike others who are considered temporarily absent from the home, a child in a child welfare placement is not eligible for BadgerCare Plus in the household that he or she was removed from.

For individuals whose eligibility is being determined under *MAGI* rules
Parents and caretakers whose children have been placed in out-of-home care and who are having their eligibility determined or renewed will still be considered parents or caretakers, as the child will be considered temporarily absent. However, the inclusion of the child in the parent's group will be dependent upon MAGI budgeting rules. If the child has been placed with a caretaker relative, the relative will not be considered the primary caretaker of the child. If there are no other dependent children in the home, this relative

would be considered a childless adult for purposes of BadgerCare Plus eligibility. Inclusion of the child in the caretaker relative's group will also be dependent upon MAGI rules. See [Chapter 10 Child Welfare Parents](#) for more information.

2.2.4 Pregnant Woman

A pregnant woman is nonfinancially eligible for BadgerCare Plus. Marital status has no effect on her nonfinancial eligibility. If she is a pregnant minor, she does not have to be under the care of or related to the caretaker to be eligible for BadgerCare Plus.

2.2.5 Former Foster Care Youth (Formerly Known as Youth Exiting Out of Home Care)

This category was formerly referred to as Youth Exiting Out of Home Care.

BadgerCare Plus benefits are available to certain individuals who were in out-of-home care, including foster care, court-ordered kinship care, and subsidized guardianship, as of their 18th birthday. These individuals are categorically eligible for BadgerCare Plus. The individual did not have to be in foster care in Wisconsin when he or she was 18 in order to be eligible for this coverage group. Through December 31, 2013, *FFCY* will only be eligible for BadgerCare Plus benefits until they are age 21. After January 1, 2014, benefits will be available to all former foster care youth under age 26. See [Chapter 11](#) for additional eligibility criteria for FFCY.

2.2.6 Child

A child under age 19 is nonfinancially eligible for BadgerCare Plus. Marital status and school enrollment status have no effect on his or her nonfinancial eligibility. The child does not have to be under the care of or related to the caretaker to be eligible for BadgerCare Plus.

Note: A child under age 19 residing with a caretaker relative may not apply as the primary person for the relative's benefits. For both a caretaker relative and a child to be included in one case, the caretaker relative must apply for BadgerCare Plus. A child under age 19 residing with a parent may not apply separately from his or her parent. In addition, the parent must apply as the primary person for the case, unless the child filing the application is age 18. Individuals over age 19 must always apply separately from their parents or caretakers, irrespective of their living arrangement or tax dependency.

2.2.7 Childless Adults

A childless adult is an individual aged 19 to 64 who does not have any dependent children under age 19 who reside with them at least 40 percent of the time. Their marital status has no effect on their BadgerCare Plus eligibility. In 2013, childless adults are covered under BadgerCare Plus through the Core Plan. Enrollment in the Core Plan has been closed since 2009. Beginning April 1, 2014, childless adults who are not

eligible for Medicare will be nonfinancially eligible for regular BadgerCare Plus under the Standard Plan.

*This page last updated in Release Number: 15-01
Release Date: 05/15/2015
Effective Date: 05/15/2015*

[View History](#)

2.3 BADGERCARE PLUS TEST GROUP

[2.3.1 The non-MAGI BadgerCare Plus Test Group](#)

[2.3.1.1 Parents and Caretaker Relatives](#)

[2.3.1.2 Essential Person](#)

[2.3.1.3 Pregnant Women](#)

[2.3.1.4 Children](#)

[2.3.1.5 Childless Adults](#)

[2.3.2 MAGI Test Group](#)

[2.3.2.1 Forming the Test Group Using MAGI Tax Filing Rules](#)

[2.3.2.2 Forming the Test Group Using MAGI Relationship Rules](#)

[2.3.2.3 MAGI Flowchart](#)

[2.3.3 Applying non-MAGI Rules vs. MAGI Rules](#)

[2.3.4 Former Foster Care Youth \(FFCY\) Eligibility](#)

The following sections outline how to form BadgerCare Plus test groups under the *non-MAGI* rules and the new *MAGI* rules. See [2.3.3 Applying non-MAGI Rules vs. MAGI Rules](#) for more information about when to apply non-MAGI rules and when to apply MAGI rules to a case.

2.3.1 The non-MAGI Test Group

For BadgerCare Plus members whose eligibility is determined using non-MAGI budgeting rules, workers should use the following methodology to determine who should be included in the member's household and whose income in that household should be counted.

The non-MAGI BadgerCare Plus Test Group includes the primary person and any individuals living in his or her household whose income and/or needs are considered when determining financial eligibility. Inclusion in the Test Group is determined by qualifying relationships and legal responsibility.

Anyone in the home who meets the criteria of being in the BadgerCare Plus Test Group is always included in the group whether or not he or she requested BadgerCare Plus.

Persons in the home who do not meet the criteria to be in a BadgerCare Plus Test Group must be excluded. However, they may be included in a BadgerCare Plus Test Group in another case.

The primary person who applies for BadgerCare Plus must meet one of the following requirements in order to form a BadgerCare Plus Test Group. The primary person must either be:

1. A parent residing with his or her child under age 19 or residing with a spouse and his or her child who is under age 19.
2. A caretaker relative residing with a child in the home who is under age 19, or an individual residing with a spouse who is a caretaker relative of a child in the home who is under age 19,
3. A pregnant woman, or the spouse of a pregnant woman,
4. A Youth under age 26 who was in out-of-home care (e.g., foster care) at age 18, or
5. A child under age 19.

2.3.1.1 Parents and Caretaker Relatives

The BadgerCare Plus Test Group for a primary person who is residing with his or her own child or with a spouse and the spouse's child will include the following individuals:

1. The primary person and the primary person's spouse.
2. A child under age 19 of the primary person or the primary person's spouse.
3. A co-parent of a primary person's child or the co-parent of the spouse's child.
4. Any spouse of a co-parent.
5. Any child under age 19 of a co-parent.
6. The other parent of a co-parent's child.
7. A child of the primary person's child or the spouse's child.
8. The spouse of an included child, if that child is a parent, or the spouse is under age 19.
9. The co-parent of an included grandchild.
10. A child under age 19 who is a qualified relative of, and who is residing with, the primary person, the primary person's spouse or another included adult, and
11. An essential person ([2.3.1.2](#))

If the primary person is a caretaker relative of a child under age 19 or the spouse of a caretaker relative of a child under age 19, the BadgerCare Plus Test Group will include the following individuals:

1. The caretaker relative,
 2. The caretaker relative's spouse,
 3. The child under age 19 who is under the care of the caretaker relative,
 4. A parent of the child, if the caretaker relative has legal custody of the child, and
 5. Any essential person ([2.3.1.2](#)).

A parent residing with his or her child under the age of 19 must be in the same BadgerCare Plus Test Group. This is true even when the legal custody of the child has been transferred to someone living outside of the home. The only exception is when someone's parental rights have been legally terminated. See [Chapter 10](#) for more information on Child Welfare Parents.

When an eligible child moves from the home of a parent or caretaker relative to the home of another caretaker relative or caretaker relative who applies for BadgerCare Plus in the same month, the new caretaker relative can be eligible as of the *application* date. The child, however, isn't eligible in the new household until the 1st of the month after his or her eligibility ends on the previous case.

Joint Placement

In determining eligibility for the parents with equivalent placement, the child is considered to be residing in both of their homes. That means the child will be included in the group size for both cases and the child's income will also be counted in both cases. See [2.2.1.2](#)

2.3.1.2 Essential Person

Note: This policy ends as of March 31, 2014.

To be included in a BadgerCare Plus test group as an essential person, the designated person must:

1. Be related to a BadgerCare Plus test group member, and
2. Be otherwise nonfinancially eligible, and

Provide at least one of the following to another BadgerCare Plus member:

- a. Child care that enables a caretaker relative to:
 - Work outside the home, full time (30 hours or more a week), for pay,
 - Receive training full time (30 hours or more a week),
1.
 - Attend HS or GED classes full time (as defined by the school).

a.

b. Care for anyone who is incapacitated.

Consider a caretaker relative incapacitated if, due to physical, emotional, or mental impairment, he or she cannot:

- Work full - time at employment paying at least Federal minimum wage, or
- Perform customary, necessary homemaking activities or provide adequate care for his or her children without help from other persons.

Only IM agency staff in positions or with authority higher than a first line IM Worker may approve, deny, and review any essential person designation. The essential person designation must be reviewed at least every six months.

Only a caretaker relative who has a child under his or her care may designate an essential person.

To designate an essential person, the caretaker relative must submit a Designation of a BadgerCare Plus Essential Person form to the IM agency. He or she must document the need for each essential person and that the person can provide the essential service.

More than one person may be designated as an essential person in the same BadgerCare Plus group, but only for different children. No one, however, may be an essential person in more than one BadgerCare Plus group. Also, there can be no essential person if there is no born child, as in a Maternity Care case.

2.3.1.3 Pregnant Women

If the primary person is:

- a pregnant woman or her spouse,
- not a parent or a caretaker relative and
- if under age 19, not residing with a parent or a caretaker relative ,

the BadgerCare Plus Test Group will include the pregnant woman and her spouse.

If the pregnant woman is under 19 and residing with a parent or caretaker, the parent or caretaker would be the primary person and the BadgerCare Plus Test Group would be built around the parent or caretaker.

Also include in the BadgerCare Plus Test Group size each fetus the pregnant woman is carrying. Verification of the number of fetuses is not required unless questionable. If the number of fetuses is unknown, add 1 to the group size. If verification is required but there is no verification on the number of fetuses, add 1 to the group size.

2.3.1.4 Children

If the primary person is a child under age 19, is not a parent or a caretaker relative of a child in the home, and is not residing with a parent or caretaker relative, the BadgerCare Plus group consists solely of the child and his or her spouse if they are residing together. In this situation, the spouse of the child under 19 is not eligible for BadgerCare Plus unless he or she is also under age 19 or there are other children in the household under the care of either the child who is the primary person or the spouse.

2.3.1.5 Childless Adults

Prior to April 1, 2014, childless adults will only be eligible for coverage under the BadgerCare Plus Core Plan. The Core Plan assistance group only consists of the childless adult and his or her spouse, if the member was married at the time of application.

2.3.2 MAGI Test Group

Beginning February 1, 2014, BadgerCare Plus eligibility determinations will use Modified Adjusted Gross Income (MAGI) rules. MAGI rules are based on the concept of an individual's tax household, not necessarily on the physical household or family relationships.

Note: Whether or not someone is a tax filer or is a dependent of a tax filer is based on what the individual plans to do for the current calendar year's taxes, not on what he or she is required to do based on IRS tax law. For example, many individuals file taxes even though they are under the filing threshold because they want to receive their full tax refund or to qualify for the Earned Income Tax Credit. If a member reports that they plan to file taxes, we will treat them as a tax filer in the test group, even if they are below the threshold for being required to file.

All new applicants with a filing date on or after February 1, 2014 will be tested only using MAGI rules. Ongoing beneficiaries will transition to MAGI rules at their next scheduled renewal or April 1, 2014, whichever is later.

An ongoing beneficiary is someone who:

- Applied prior to February 1, 2014,
 - Was eligible for March 2014, and
 - Remained eligible under the new income limits after April 1, 2014.

Note: Ongoing cases that had a renewal in January or February of 2014 will transition to MAGI rules the next time eligibility is run by the worker for the month of April 2014 or later.

2.3.2.1 Forming the Test Group using MAGI Tax Filing Rules

All MAGI groups are based on a “target” individual. Each person who can become eligible for BadgerCare Plus on the application will be a target during the eligibility determination for a case.

Tax Filers

If the individual is a tax filer and is NOT being claimed as a dependent by anyone else, then the individual’s MAGI group consists of the tax filer, the tax filer’s spouse, and any dependents the tax filer is claiming.

Out-of-the-Home Tax Dependents

A tax filer is able to claim individuals who live outside of their home as their tax dependents. Common examples include college students and other adult children, elderly parents, or siblings who do not live with the filer(s). Tax filers can also claim a deceased child as his or her tax dependent in the year that the child has died. In these instances, the deceased child would be included in the tax filer’s group size, though the child would not be eligible for benefits on that application.

Deceased Co-Filers

It is possible for an individual to file his or her taxes jointly with a deceased spouse for the taxable year in which the spouse died. However, unlike deceased tax dependents, they will not be included as a household member.

Household Members in the Military

Deployed military members are still considered part of a tax household. Under MAGI rules, the military member’s taxable income will count in the household, and he or she will also be included in the household’s group size, as appropriate. If a household member is absent due to military activity, he or she may be included in the group size, but will not be eligible for assistance on this case.

Married Couples

Married individuals who are living together are always included in each other’s group size, even if they are filing taxes separately. If a married couple is living apart but filing jointly, the couple is included in each other’s group size. If the married couple is living apart and filing taxes separately, or are not planning to file taxes, do not include them in each other’s group size.

Tax Dependents

In general, a tax dependent’s household will be the same as his or her tax filer’s household, even if the tax dependent is also a tax filer.

However, if any of the following situations apply, then the tax dependent’s eligibility is based on MAGI relationship rules:

2.3 BadgerCare Plus Test Group

1. The individual is being claimed as a dependent by a parent outside of the home (a non-custodial parent is defined as a parent who is living apart from the parent applying for benefits for the child),
2. The individual is being claimed as a dependent by someone who is not their parent; or
3. The individual lives with both parents and his or her parents are not married filing jointly.

2.3.2.2 Forming the Test Group Using MAGI Relationship Rules

Individuals who meet one of the exceptions to the MAGI tax filing rules or who are not tax filers or tax dependents will have their eligibility determined using MAGI relationship rules.

Under relationship rules, only include individuals who are living in the home with the target. If the target individual is under 19, then the target's group includes the target's parents, the target's spouse, the target's siblings under age 19 (including step and half siblings), and the target's children.

If the target individual is over age 19, the target's group includes the target's spouse and the target's children under age 19.

2.3.2.3 MAGI Flowchart

The following flowchart may assist workers in forming groups under MAGI rules.

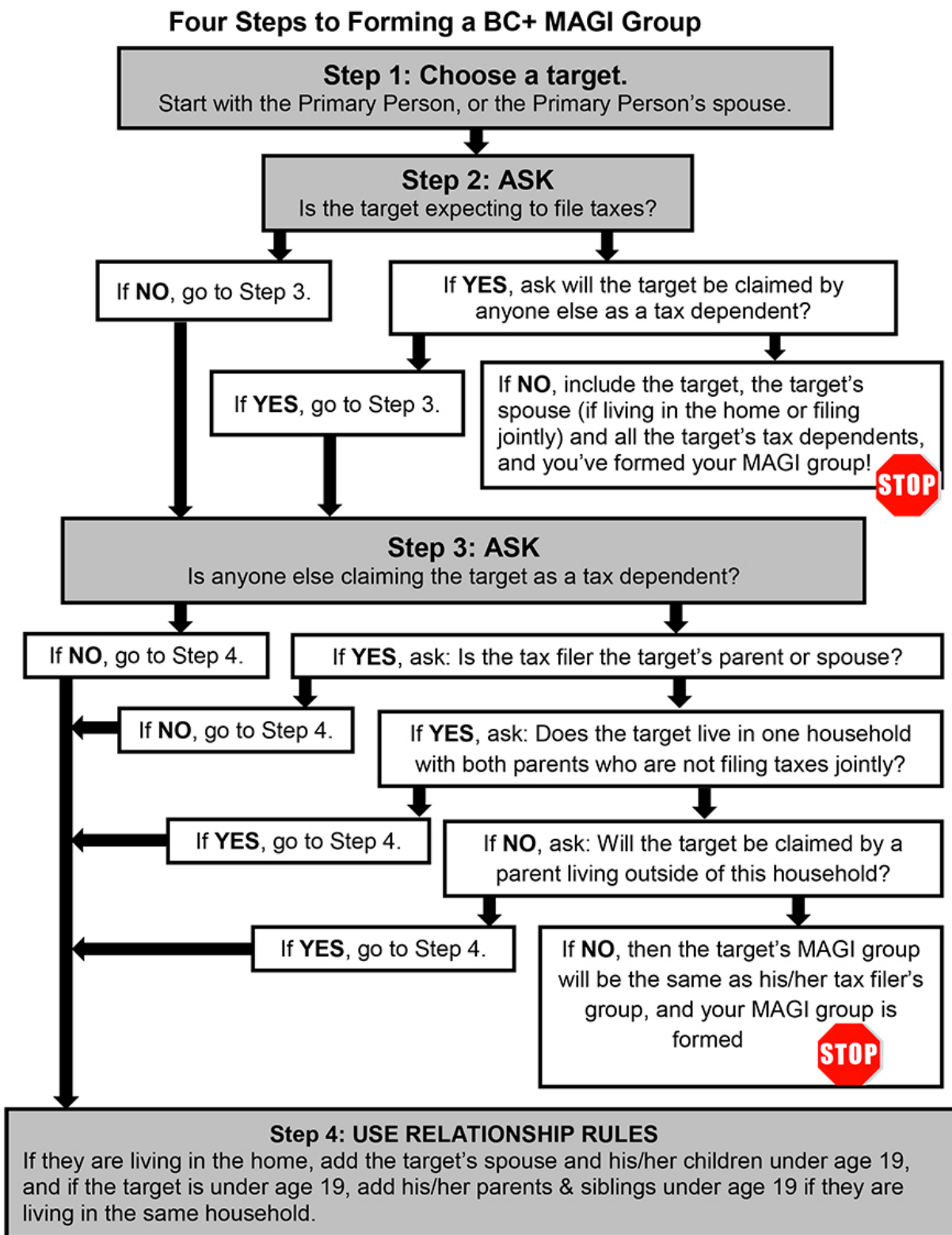

2.3.3 Applying non-MAGI Rules vs. MAGI Rules

Applications Submitted to the Department of Health Services

Individuals who apply for BadgerCare Plus prior to February 1, 2014 will have their eligibility determined using *non-MAGI* rules. These individuals will continue to be subject to non-MAGI rules until March 31, 2014 or their next regularly scheduled 2014 renewal, whichever comes later.

If an individual with eligibility under non-MAGI rules reports a change that makes them ineligible for BadgerCare Plus, MAGI information will be collected and their eligibility re-run under MAGI rules in order to determine if the individual may still be eligible for BadgerCare Plus.

Individuals who apply for BadgerCare Plus coverage on or after February 1, 2014 will have their eligibility determined under MAGI rules. If they request backdated eligibility for a month prior to February 2014, we will use non-MAGI rules for those months.

Applications Submitted to the Federally-facilitated Marketplace

Beginning October 1, 2013, individuals can submit applications for Medicaid or CHIP coverage to the federally-facilitated marketplace (the Marketplace). If the Marketplace determines or assesses individuals as eligible for coverage through BadgerCare Plus or EBD Medicaid, the account will be transferred to Wisconsin.

The filing date for applications received from the Marketplace is the date the application was submitted to the Marketplace. The 30 day processing time frame begins on the date the application is submitted to the IM agency's inbox.

Effective February 1, 2014, DHS will send accounts of applicants and members found ineligible for BadgerCare Plus to the *Marketplace* for a determination of advanced premium tax credits and cost-sharing reductions.

2.3.4 Former Foster Care Youth Eligibility

Former Foster Care Youth are categorically eligible for BadgerCare Plus.

Through December 31, 2013, if the primary person is:

- A former foster care youth,
- under 21 years old,

then the BadgerCare Plus test group will include the youth and his or her spouse if the spouse is also a former foster care youth.

Beginning January 1, 2014, if the primary person is:

- a former foster care youth,
- under age 26,
-

then the BadgerCare Plus group will include the youth and his or her spouse if the spouse is also a former foster care youth.

This page last updated in Release Number: 14-01

Release Date: 02/07/14

Effective Date: 02/01/14

[View History](#)

2.4 THE BADGERCARE PLUS HOUSEHOLD

[2.4.1 Not Living in the Household](#)

[2.4.2 Temporary Absence](#)

[2.4.3 Students](#)

"Living in the Household" means all individuals residing in or temporarily absent ([3.5.1](#)) from the same residence. This includes:

1. People living in the home in a community residential confinement program. The Department of Corrections (DOC) electronically monitors them.
2. Huber law prisoners who are released from jail to attend to the needs of their families can become eligible for BadgerCare Plus. If the other parent is continuously absent, the Huber law prisoner may be the caretaker relative in the household if the prisoner:
 - a. Intends to return to the home, and
 - b. Continues to be involved in the planning of the support and care of the minor children.

Huber Law prisoners who are released for a purpose other than attending to the needs of their families are not eligible for BadgerCare Plus. Consider them to be absent parents.

2.4.1 Not Living in the Household

Do not consider the following to be living in the household regardless of whether *non-MAGI* rules or *MAGI* rules were used to determine a member's BadgerCare Plus group:

1. Inmates of a public institution, even if they are temporarily absent from the home with the following exceptions:

- a. Pregnant inmates applying for the BadgerCare Plus Prenatal Program.
- b. If an inmate resides outside of a public correctional institution for more than 24 hours at any one time, he or she can qualify for BadgerCare Plus during that time period if he or she meets all other eligibility criteria. For example, if an inmate is admitted as an inpatient to a non-prison hospital for 24 hours, that inmate could qualify for Medicaid for that day, if otherwise eligible.

2.4.2 Temporary Absence

A child and that child's parent or caretaker relative can be in the same BadgerCare Plus Test Group even when not living together if either is temporarily absent, provided:

1. The continuous absence is expected to be for no more than six months.

The IM agency may approve an extension of a child's temporary absence beyond six months when the caretaker relatives meet the Child Welfare Caretakers requirements.

and

2. The *caretaker relative* continues to exercise responsibility for the care and control of the child. See [Chapter 10](#) for more information about Child Welfare.

The following children are not considered temporarily absent:

- Children who are inmates of public institutions. ([3.6](#))
- Children who are placed in an institution for 30 or more days, unless they were placed there by a child welfare agency.
- Children who are placed in an *IMD*, unless they were placed there by a child welfare agency.

2.4.3 Students

When a child under age 19 who is a student living away from their parent's home applies for BadgerCare Plus, the child and his or her family can determine whether the student will be on his or her own case, or a temporarily absent individual included in his or her parent's case.

Students over age 19 will need to apply for BadgerCare Plus with their own application.

*This page last updated in Release Number: 13-02
 Release Date: 10/25/13
 Effective Date: 10/01/13*

[View History](#)

2.5 BadgerCare Plus Assistance Groups

Because of different BadgerCare Plus group requirements, individuals within the BadgerCare Plus test group are placed into a BadgerCare Plus Assistance Group (AG).

Every BadgerCare Plus AG will have at least one potentially eligible member. Besides these potentially eligible members, other individuals may be designated as a person whose income will be counted when determining financial eligibility. Still others may be counted only in the group size. Some individuals on the application will not be considered at all when determining eligibility. Placement in the BadgerCare Plus AG is dependent on age, and relationships to the individual(s) whose eligibility is being determined.

The following are the BadgerCare Plus Assistance Groups for individuals whose eligibility is being determined using *non-MAGI* rules:

AG	Description
BCPY:	Former Foster Care Youth
BCPP:	Pregnant women, including those who become eligible by meeting a deductible , or who are eligible for the BadgerCare Plus Prenatal Program.
BCPB	Continuously Eligible Newborns
BCPM	Non-pregnant, non-disabled adults in extensions who owe a premium.
BCPN	Persons who are caretakers relatives, or the spouses of caretakers relatives in the home including Child Welfare caretakers
BCPL	Children living with caretaker relatives
BCPC	Children under age 19, living alone or with a parent or parents

2.4 The BadgerCare Plus Household

BCPA	Persons age 19 or older who are parents, or stepparents of a child in the home, including Child Welfare parents
BCPD	Children who are eligible through meeting a deductible
BCPE	Adults and children in Earned Income and Child Support Extensions who do not owe a premium

The following are the BadgerCare Plus Assistance Groups for individuals whose eligibility is being determined using the *MAGI* rules. These AGs will not be effective until February 1, 2014.

AG	Description
MAGY	Former Foster Care Youth
MAGP	Pregnant women, including those who are eligible for the BadgerCare Plus Prenatal Program and those who become eligible after meeting a deductible.
MAGB	Continuously Eligible Newborns
MAGM	Adults in extensions who owe a premium.
MAGN	Persons who are caretakers relatives, or the spouses of caretakers relatives in the home, including Child Welfare caretakers
MAGL	Children living with non-legally responsible relatives
MAGC	Children under age 19, living alone or with a parent or parents
MAGA	Persons age 19 or older who are parents, or stepparents of a child in the home, including Child Welfare parents
MAGD	Children who are eligible through meeting a deductible
MAGE	Children and Adults in Earned Income and Spousal Support Extensions who do not owe a premium
MAGS	Childless adults

This page last updated in Release Number: 14-01
 Release Date: 01/30/14
 Effective Date: 01/30/14

[View History](#)

2.6 Participation Status Codes

The participation status code for each individual in the BadgerCare Plus assistance group indicates whether the individual is eligible, counted or excluded in that assistance group.

Status Code		Budgeting Rules (non-MAGI/ MAGI)	Description	Include in the Group Size?
CA	Counted Adult	non-MAGI and MAGI	Ineligible for BadgerCare Plus in this AG	Yes
CC	Counted Child	non-MAGI and MAGI	Ineligible for BadgerCare Plus in this AG	Yes
EA	Eligible Adult	non-MAGI and MAGI	Non-financially eligible in this BadgerCare Plus AG	Yes
EC	Eligible Child	non-MAGI and MAGI	Non-financially eligible in this BadgerCare Plus AG	Yes
TC	Test Child	non-MAGI	Ineligible for BadgerCare Plus solely because receives SSI or Adoption Assistance	Yes
TA	Test Adult	non-MAGI	Ineligible for BadgerCare Plus solely because receives SSI or 1619b	Yes
XA	Excluded Adult	non-MAGI and MAGI	Ineligible for BadgerCare Plus in this AG	No

2.4 The BadgerCare Plus Household

XC	Excluded Child	non-MAGI and MAGI	Ineligible for BadgerCare Plus in this AG	No
----	----------------	-------------------	---	----

This page last updated in Release Number: 13-02
 Release Date: 10/25/13
 Effective Date: 10/01/13

[View History](#)

2.7 BadgerCare Plus Group Examples

[2.7.1 BadgerCare Plus Group Examples using non-MAGI Rules](#)

[2.7.2 BadgerCare Plus Group Examples using MAGI Rules](#)

2.7.1 BadgerCare Plus Group Examples using non-MAGI Rules

Example 1

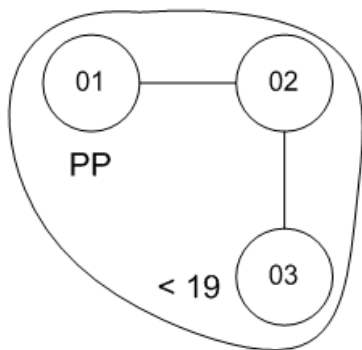

Individuals	01	02	03
Health Care Request	Y	Y	Y
Assistance Group	Individual Part status		
BCPA	EA	EA	CC
BCPC	CA	CA	EC

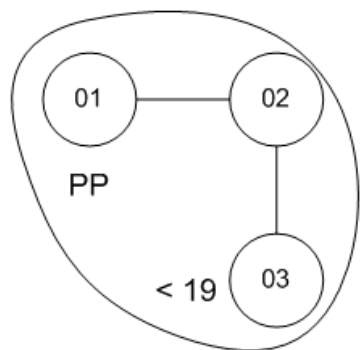

Individuals	01	02	03
Health Care Request	Y	N	Y
Assistance Group	Individual Part status		
BCPA	EA	CA	CC
BCPC	CA	CA	EC

Example 2

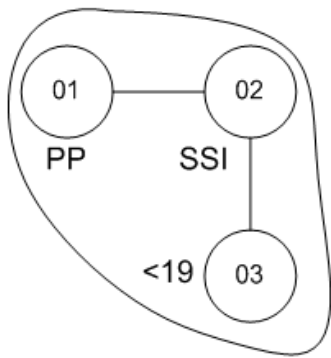

Individuals	01	02	03
Health Care Request	Y	Y	N
Assistance Group	Individual Part status		
BCPA	EA	TA	CC

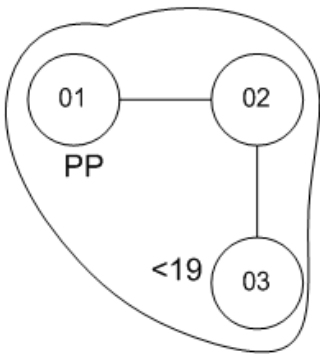

Individuals	01	02	03
Health Care Request	Y	Y	N
Assistance Group	Individual Part status		
BCPA	EA	EA	CC

Example 3

2.4 The BadgerCare Plus Household

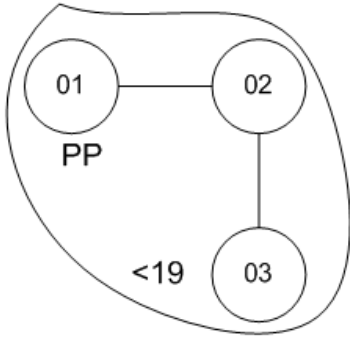

Individuals	01	02	03
Health Care Request	Y	N	N
Assistance Group	Individual Part status		
BCPA 01	EA	CA	CC

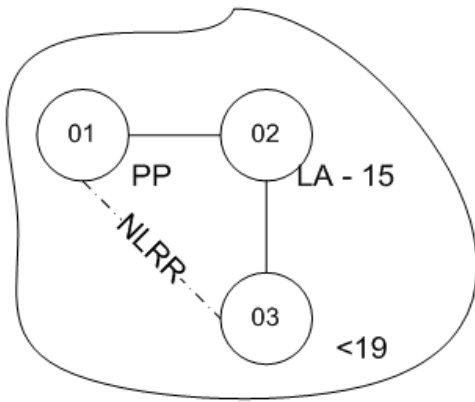

Individuals	01	02	03
Health Care Request	Y	Y	N
Assistance Group	Individual Part status		
BCPN 01	EA	XA	XC

Example 4

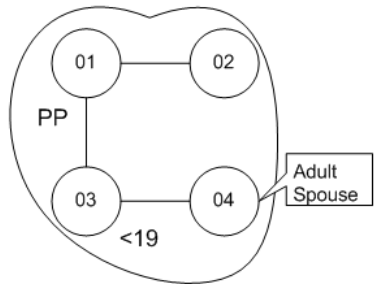

Individuals	01	02	03	04
Health Care Request	Y	Y	Y	Y
Assistance Group	Individual Part status			
BCPA 01	EA	EA	CC	CA
BCPC 01	CA	CA	EC	CA

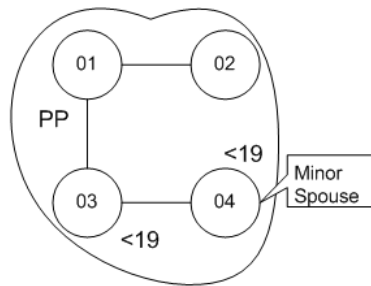

Individuals	01	02	03	04
Health Care Request	Y	Y	Y	Y
Assistance Group	Individual Part status			
BCPA 01	EA	EA	CC	CC
BCPC 01	CA	CA	EC	EC

Example 5

2.4 The BadgerCare Plus Household

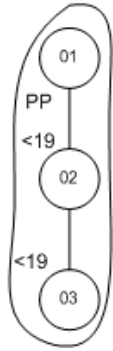

Individuals	01	02	03	
Health Care Request	Y	Y	Y	
Assistance Group	Individual Part status			
BCPA	EA	CC	CC	
BCPC	CA	EC	EC	

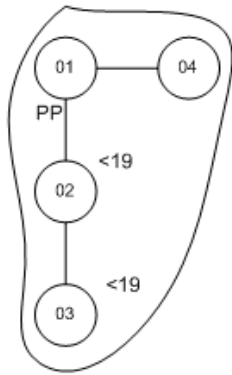

Individuals	01	02	03	04
Health Care Request	Y	Y	Y	Y
Assistance Group	Individual Part status			
BCPA	EA	CC	CC	EA
BCPC	CA	EC	EC	CA

Example 6

Example 7

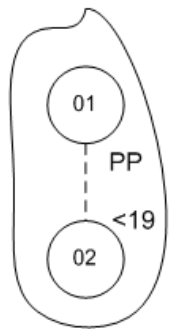
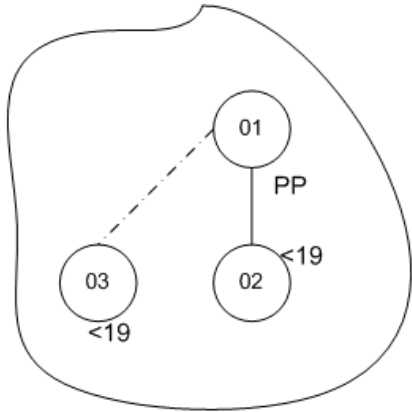

Individuals	01	02	03		
Health Care Request	Y	Y	Y		
Assistance Group	Individual Part status				
BCPA 01	EA	CC	XC		
BCPC 01	CA	EC	XC		
BCPL 01	XA	XC	EC		

Individuals	01	02			
Health Care Request	Y	Y			
Assistance Group	Individual Part status				
BCPN 01	EA	XC			
BCPL 01	XA	EC			

Example 8

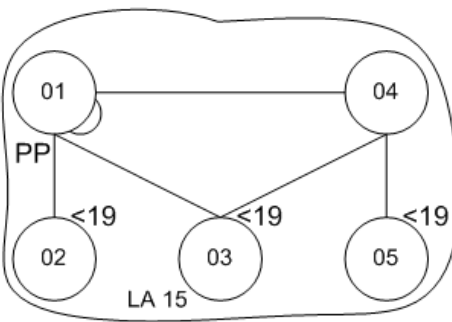
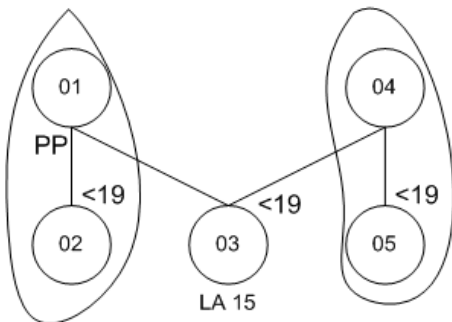

Individuals	01	02	03	04	05
Health Care Request	Y	Y	Y	Y	Y
Assistance Group	Individual Part status				
BCPA	EA	CC	XC	XA	XC
BCPC	CA	EC	XC	XA	XC

Individuals	01	02	03	04	05
Health Care Request	Y	Y	Y	Y	Y
Assistance Group	Individual Part status				
BCPP	EA	CC	XC	CA	CC
BCPA	CA	CC	XC	EA	CC
BCPC	CA	EC	XC	CA	EC

2.7.2 BadgerCare Plus Group Examples using MAGI Rules

Example 1

Temperance (36) and Seeley (40) are married parents and are not filing taxes. They have one daughter, Christine (1).

Person	BC+ Category	Temperance	Seeley	Christine
Temperance	MAGA	EA	CA	CC
Seeley	MAGA	CA	EA	CC
Christine	MAGC	CA	CA	EC

Example 2

Mr. and Mrs. Bennett are married parents filing taxes separately but living together. They have two daughters, Jane (18) and Elizabeth (17). Jane’s husband, Charles (20) also lives with them. Mr. Bennett is claiming Jane, Elizabeth, and Charles as his tax dependents.

Person	BC+ Category	Mr. Bennett	Mrs. Bennett	Jane	Elizabeth	Charles
Mr. Bennett	MAGA	EA	CA	CC	CC	CA
Mrs. Bennett	MAGA	CA	EA	XC	XC	XA
Jane	MAGC	CA	CA	EC	CC	CA
Elizabeth	MAGC	CA	CA	CC	EC	XA
Charles	MAGS	XA	XA	CC	XC	EA

Example 3

Evie (29) and Derrick (32) are divorced parents. Their son, Neal (8), lives with Evie 80% of the time and 20% of the time with Derrick. Per their divorce agreement, this is Derrick’s year to claim Neal as his tax dependent. Evie also files taxes. Evie is pregnant with her second child. Evie, Derrick, and Neal are all applying for health care. Evie and Neal will be on their own application. Derrick will have to apply on a separate application.

Person	BC+ Category	Evie	Derrick	Neal
Evie	MAGA	EA (+1)	-	XC
Derrick	MAGS	-	EA	CC
Neal	MAGC	CA (+1)	-	EC

Example 4

Same as above, except Neal lives 60% of the time with Evie and 40% of the time with Derrick, and neither Evie nor Derrick file taxes.

Person	BC+ Category	Evie	Derrick	Neal
Evie	MAGA	EA (+1)	-	CC
Derrick	MAGA	-	EA	CC
Neal	MAGC	CA (+1)	-	EC

Example 5

George (50) and Lucille (40) are married tax filers and are filing jointly. They have three tax dependents: Michael (14), Lindsay (14), and Buster (6). Buster is Lucille’s nephew who George and Lucille care for. Michael and Lindsay are George and Lucille’s children. George and Lucille also care for George’s nephew Tobias (17) but will not claim him as a tax dependent. All six individuals are requesting health care.

Person	BC+ Category	George	Lucille	Michael	Lindsay	Buster	Tobias
George	MAGA	EA	CA	CC	CC	CC	XC
Lucille	MAGA	CA	EA	CC	CC	CC	XC
Michael	MAGC	CA	CA	EC	CC	CC	XC
Lindsay	MAGC	CA	CA	CC	EC	CC	XC
Buster	MAGL	XA	XA	XC	XC	EC	XC
Tobias	MAGL	XA	XA	XC	XC	XC	CC

Example 6:

Danny (45) and Vicki (40) are non-married co-parents. They submit a BadgerCare Plus application for themselves, Danny’s daughter DJ (22), Vicki’s daughter Stephanie (13) Danny and Vicki’s daughter, Michelle (10) and Danny’s brother, Uncle Jesse (40). Danny claims DJ and Jesse as his tax dependents, while Vicki claims Stephanie and Michelle as her tax dependents.

Person	BC+ Category	Danny	Vicki	DJ	Stephanie	Michelle	Jesse
Danny	MAGA	EA	XA	CA	XC	XC	CA
Vicki	MAGA	XA	EA	XA	CC	CC	XA
DJ	MAGS	CA	XA	EA	XC	XC	CA
Stephanie	MAGC	XA	CA	XA	EC	CC	XA
Michelle	MAGC	CA	CA	XA	CC	EC	XA
Jesse	MAGS	XA	XA	XA	XC	XC	EA

Note: Uncle Jesse and DJ will need to file their own applications.

Example 7

Emily is a 52 year old grandmother who cares for her daughter, Lorelai (18) and her granddaughter, Rory (2). Emily is the primary caretaker of Rory. Lorelai has graduated high school. Nobody files taxes.

Person	BC+ Category	Emily	Lorelai	Rory
Emily	MAGN	EA	XC	XC
Lorelai	MAGC	CA	EC	CC
Rory	MAGC	XA	CC	EC

Example 8

Same example as example 7, except Emily is claiming Lorelai and Rory as her tax dependents.

Person	BC+ Category	Emily	Lorelai	Rory
Emily	MAGN	EA	CC	CC
Lorelai	MAGC	CA	EC	CC
Rory	MAGC	XA	CC	EC

*This page last updated in Release Number: 14-02
 Release Date: 05/14/14
 Effective Date: 04/01/14*

[View History](#)

2.8 BadgerCare Plus Test Group Financial Rules

[2.8.1 Non-MAGI Income Counting Rules](#)

[2.8.2 MAGI Income Counting Rules](#)

2.8.1 Non-MAGI Income Counting Rules

Under *non-MAGI* BadgerCare Plus rules, the income and/or needs of all BadgerCare Plus Test Group members will be used to determine financial eligibility for all members of the BadgerCare Plus Test Group.

Exception: If a child is living with a caretaker relative, the child’s financial eligibility is determined using only the child’s income. The income from the *caretaker relative* and the caretaker relative’s spouse is never used in the child’s eligibility determination. Likewise, the child’s income is never used when determining the eligibility of the caretaker relative and his or her spouse. In addition, caretaker

relative and the children living with the caretaker relative do not count each other when determining the BadgerCare Plus Test Group sizes.

All members in the BadgerCare Plus Test Group will be counted when determining the BadgerCare Plus Test Group size even when there is no health care request for a member.

The income of all counted adults and children in the BadgerCare Plus Test Group is used when determining the financial eligibility for all Test Group members, except the income of SSI recipients or other Test Adults or Test Children.

Test Children and Test Adults are included in the group size but their income is not counted when determining eligibility for the group.

2.8.2 MAGI Income Counting Rules

Within each *MAGI* assistance group, all counted and eligible individuals' income is counted with one exception: if a group member is a child or tax dependent of a counted or eligible member within the same assistance group, his or her income is only counted if he/she is "expected to be required" to file a tax return for the current year. If the tax dependent or child chooses to file a tax return when they are not required to, we will not count their income. Tax dependents' and children's income is only counted when they are "expected to be required" to file a tax return.

Note: If a child or tax dependent is the only individual in the MAGI group, he or she would not have a parent or tax filer eligible or counted in that group. As a result, his or her income will always be counted, regardless of whether or not she or he is expected to be required to file taxes. *NLRR* children are an example of a child who is the only counted or eligible individual in a MAGI group.

Tax dependents are only required to file a tax return if they have more income than the filing thresholds set by the IRS each year. If the child or tax dependent of another member in the same AG expects to have less annual taxable income than the amounts below, his or her income is not included in the eligible determination for the AG.

Amounts effective January 1, 2015:

- \$1,050 per year in taxable unearned income, or
- \$6,300 per year in taxable earned income.

For expected unearned income, do not count Child Support, Social Security, Supplemental Security Income (SSI), Workers Compensation, Veteran's Benefits, Money from Another Person or Educational Aid.

2.4 The BadgerCare Plus Household

These income counting rules apply regardless of whether the assistance group was formed based on MAGI Tax Filing Rules or MAGI Relationship Rules.

The income of household members who are currently out of the home due to military activity will still be counted according to MAGI rules, meaning it may be counted, even though the individual will not be eligible on the case.

Example 1: Jack and Jill are married and will be filing a joint tax return. They have two children, Mickey (16) and Minnie (12), whom they will claim as tax dependents. Minnie has no income, but Mickey works at McDonald's earning approximately \$100 per month. Mickey's annual earned income is expected to be \$1200; he is not expected to be required to file a tax return at the end of the year. Mickey's income is not counted.

Example 2: Daisy plans to file taxes this year. She has one tax dependent, her son Donald (16), who works part-time at a grocery store. He earns \$550 per month; with an annual income of \$6,600. Based on this income, Donald will be expected to be required to file a tax return. Donald's income is counted.

Example 3: Kelly and Zack are non-married co-parents and have two children, Jessie (17) and Albert (14). Albert mows lawns in the summer and makes around \$300 for the year. The only other income in the household is Zack's unemployment payment in the amount of \$400 per month (\$4800 per year). Kelly and Zack do not plan to file taxes. Albert is not expected to be required to file taxes. The AGs for this case will be based on non-MAGI relationship rules since there is no tax filer in the household. Zack's UI payment will be counted, but Albert's self-employment income is not counted because he is not expected to be required to file.

Example 4: Michael (16) and his sister Janet (17) live with their aunt Barb and her two children. Barb applies for BadgerCare Plus for herself, her two children and her niece and nephew. Barb states she plans to file taxes and will be claiming Michael, Janet, and her two children as tax dependents. Barb is self-employed earning about \$800/mo. Michael is working part-time at Dairy Queen earning approximately \$150/month. Michael is not expected to be required to file taxes. Janet works part-time at Copp's and makes \$600/mo. She will be expected to be required to file taxes.

Outcome for Barb

Barb's assistance group will consist of herself and all four children since she will be claiming them as tax dependents. Michael's income will not be counted in Barb's AG because he is not expected to be required to file taxes, but Janet's income will be counted in Barb's group because Janet is expected to be required to file taxes. Barb's children's AGs will be the same as Barb's AG.

Outcome for Michael and Janet

Michael and Janet will both have an assistance group of two (MAGL) since they are siblings being claimed as tax dependents by someone living in the home who is not their parent. Michael and Janet's groups are built using MAGI relationship rules. All of

Michael's and Janet's earned income will be countable when determining their eligibility because they are not the children or tax dependents of someone in their group.

*This page last updated in Release Number: 15-01
Release Date: 05/15/2015
Effective Date: 05/15/2015*

3 Residence

[View History](#)

3.1 RESIDENCE

A person must be a Wisconsin resident to be eligible for BadgerCare Plus. He or she must:

1. Be physically present in Wisconsin. There is no minimum requirement for the length of time the person has been physically present in Wisconsin. Wisconsin residents who are temporarily out of state (see [3.5 Absence from Wisconsin](#)), including students going to school in another state, do not have to be physically present to apply. However, individuals who are not Wisconsin residents and intend to move to Wisconsin must be physically present in Wisconsin to apply.

and

2. Express intent to reside in Wisconsin. (see [3.2 Intent to Reside](#).) Effective January 1, 2014, an individual can also be considered a resident of Wisconsin if they are physically present in the State and have entered Wisconsin with a job commitment or seeking employment, whether or not they are employed at the time of application.

Example 1: John, a student from Wisconsin who is attending college in Minnesota, can apply for BadgerCare Plus as a Wisconsin resident.

Example 2: Margie lives in Florida. She is planning to move to Wisconsin in the next few months. Margie would not be considered a resident of Wisconsin until she is physically present in Wisconsin.

Example 3: This is George's first day in Wisconsin. He states that he intends to reside in Wisconsin. For BadgerCare Plus purposes, George is a Wisconsin resident.

Migrant Farm Worker

A migrant who meets the following conditions is a Wisconsin resident:

1. His or her primary employment in Wisconsin is in the agricultural field or cannery work,
2. He or she is authorized to work in the US,
3. He or she is not related (immediate family) by blood or marriage to the employer (as distinguished from a "crew leader"), and
4. He or she routinely leaves an established place of residence to travel to another locality to accept seasonal or temporary employment.

See [12.3](#) for Special Migrant Laborer Processing Instructions.

*This page last updated in Release Number: 14-02
Release Date: 05/14/14
Effective Date: 04/01/14*

[View History](#)

3.2 INTENT TO RESIDE

The intent to reside requirement applies to any adult age 18 or older who is capable of indicating intent. An adult is incapable of, and thus exempt from, indicating intent when:

1. He or she is judged legally incompetent by a court of record; or
2. His or her I.Q. is 49 or less or he or she has a mental age of 7 or less, based on tests acceptable to Wisconsin's Department of Health Services (DHS); or
3. Medical documentation obtained from a physician, psychologist, or other person licensed by Wisconsin in the field of developmental disability supports a finding that he or she is incapable of indicating intent.

“Intent to reside” does not mean an intent to stay permanently or indefinitely in the State, nor does it require an intent to reside at a fixed address.

*This page last updated in Release Number: 13-02
Release Date: 10/25/13
Effective Date: 10/01/13*

[View History](#)

3.3 DETERMINING STATE RESIDENCY

[3.3.1 Under Age 21](#)

[3.3.2 Age 21 and Over](#)

3.3.1 Under Age 21

Not in an institution

A person under age 21 and not residing in an institution is a Wisconsin resident if he or she is:

- Age 18 or under age 18 and emancipated from his or her parents, or married, and is:
 1. Living in Wisconsin with the intent to remain living in Wisconsin, or
 2. Living in Wisconsin and entered Wisconsin with a job commitment or to seek employment.
- Under age 18 and not emancipated from his or her parents and not married, and is living in Wisconsin.

Note: For individuals received Medicaid based on receipt of Title IV-E assistance or if the individual receives State SSI, see section [3.4](#).

- Living in another state when Wisconsin or one of its county agencies has legal custody of him or her.
- Living here and is eligible based on blindness or disability.

In an institution

The residence of a person under age 21 living in a Wisconsin institution when his or her parents or legal guardian lives outside of Wisconsin is the state in which the parent or legal guardian states the institutionalized person is present, and intends to stay.

If the parents have abandoned him or her and no legal guardian has been appointed, his or her residence is the state in which the institution is located, and the person making the Medicaid *application* must reside in the same state.

If he or she is married, his or her residence is the institution's state.

3.3.2 Age 21 and Over

Not in an Institution

The residence of an individual over age 21 who is not institutionalized is Wisconsin if he or she is:

- Living in Wisconsin with the intent to remain living in Wisconsin, or
- Living in Wisconsin and entered Wisconsin with a job commitment or to seek employment.

If he or she is incapable of expressing intent, an individual is a resident if he or she is living in Wisconsin.

In an institution

The residence of a person who became incapable of indicating intent before age 21 is determined in the same way as the residence of an institutionalized person under age 21.

The residence of a person who became incapable of indicating intent at age 21 or older is Wisconsin, unless the placement was arranged by another state.

For all others, the person is a Wisconsin resident if he or she intends to reside in Wisconsin

*This page last updated in Release Number: 13-02
Release Date: 10/25/13
Effective Date: 10/01/13*

[View History](#)

3.4 SPECIAL SITUATIONS

3.4.1 State Supplementary Payment

The State Supplementary Payment (SSP) is the portion of an SSI payment paid by a state, not by the federal government. A person receiving SSP payments is a resident of the state making the SSP payment.

3.4.2 IV-E Children

Federal financial participation is available under Title IV-E of the Social Security Act to pay for all or part of a person's foster care or subsidized adoption. IV-E eligible children are

categorically eligible for BadgerCare Plus in the state where they reside.

It does not affect any maintenance payments for substitute care.

These cases are certified manually outside of *CARES*.

3.4.3 Non IV-E Foster Children

Wisconsin certifies BadgerCare Plus eligibility for non IV-E foster children living in another state when Wisconsin or one of its county/tribal agencies has legal custody of the child.

Non IV-E foster children are automatically eligible for BadgerCare Plus.

These cases are certified for BadgerCare Plus manually outside of CARES.

3.4.4 Homeless Persons

A homeless person living in Wisconsin meets the requirement of being physically present in Wisconsin. The agency is responsible for using its own address or some other fixed address for purposes of mailing the BadgerCare Plus card to eligible applicants who have no fixed dwelling place or mailing address.

*This page last updated in Release Number: 13-02
Release Date: 10/25/13
Effective Date: 10/01/13*

[View History](#)

3.5 ABSENCE FROM WISCONSIN

Once established, Wisconsin residency is retained until :

1. The person notifies states that they no longer intend to reside in Wisconsin,
2. Another state determines the person is a resident in that state for Medicaid/Medical Assistance ,
3. Other information is provided that indicates the person is no longer a resident.

3.5.1 Temporary Absence

Temporary absence ends when another state determines the person is a resident there for Medicaid/Medical Assistance purposes.

*This page last updated in Release Number: 07-02
Release Date: 11/19/07
Effective Date : 02/01/08*

[View History](#)

3.6 INMATES

[3.6.1 General BadgerCare Plus Application Process for Inmates of State Correctional Institutions](#)

[3.6.2 BadgerCare Plus Application Process for Inmates with Multiple Inpatient Admissions](#)

[3.6.3 Huber Law](#)

An inmate is residing in a public institution on an involuntary basis. For example, a prisoner in a jail, prison, or other correctional facility is considered an inmate. A staff person voluntarily residing in a public institution is not considered an inmate. An individual voluntarily residing in an institution while waiting for other living arrangements to be made that are appropriate to the person's needs is not considered an inmate. An individual who is legally confined to his or her home by a monitoring device, such as an ankle bracelet, is not considered an inmate for the purposes of BadgerCare Plus. Individuals who are inmates of a public institution are not eligible for BadgerCare Plus unless they meet the Huber criteria or the following two exceptions:

- **Prenatal exception:** Pregnant women may apply for and enroll in the BadgerCare Plus Prenatal Program (see [Chapter 41 BadgerCare Plus Prenatal Program](#)) while they are inmates.
- **Inpatient exception:** If an inmate resides outside a public correctional institution for more than 24 hours at any one time, he or she can qualify for BadgerCare Plus during that time period if he or she meets all other eligibility criteria. For example, if an inmate of a public institution is admitted as an inpatient to a medical institution for 24 hours or more and is otherwise eligible, manually certify him or her for BadgerCare Plus from the admission date through the discharge date.

3.6.1 General BadgerCare Plus Application Process for Inmates of State Correctional Institutions

Use the following process for inmates of state correctional institutions:

1. **DOC** staff submits an ACCESS application, which will be systematically routed to **EM CAPO**. Superintendents of state correctional facilities (wardens) or their designee may sign the application for the inmate. Refer to the [Medicaid Eligibility](#)

[Handbook, Section 6.9.4 State Correctional Institutions](#) for the list of state correctional facilities at which the warden may sign the application.

2. Process the inmate as a one-person household with a living arrangement of "01-Independent (Home/Apt/Trlr)" on the [Current Demographics](#) page.
3. If the individual is eligible, close the case in CARES by changing the Healthcare Request page to "N." Suppress CARES-generated notices for Medicaid and any program the individual has not requested. Manually certify the individual with the appropriate medical status code (see [Process Help, Section 81.5 Med Stat Code Chart](#) for a list of medical status codes), from the hospital admission date through the date of discharge. If the individual has not yet been discharged, certify the individual from the date of admission through the estimated discharge date. Send a manual positive notice to DOC indicating the dates of eligibility. Also, if the individual had not been discharged when you sent the initial positive notice, send a manual negative notice with the eligibility end date as soon as that is known. If you issue the notice after the discharge date, the effective date of the termination and the notice should be the date you mail the notice. The reason for the termination should be shown as "Individual is incarcerated." The legal citation should read "DHS 103.03(6)." For situations in which an inmate has multiple inpatient admissions, see [Section 3.6.2 BadgerCare Plus Application Process for Inmates with Multiple Inpatient Admissions](#).

Note: It is not necessary to provide a 10-day notice of termination for Medicaid when the reason for termination is the return of the individual to prison. The notice is considered timely if it is mailed no later than the termination effective date.

4. If the individual is ineligible, confirm the denial in CARES, and allow CARES-generated notices to be sent to the designated DOC staff person.

3.6.2 BadgerCare Plus Application Process for Inmates with Multiple Inpatient Admissions

Generally, a new application must be submitted for each inpatient admission for an inmate even if the inmate has already been verified as Medicaid-eligible for a previous inpatient admission.

Exception: If an application is pending and an inmate has multiple inpatient admissions prior to the application being approved, then all of those eligibility segments can be certified under one application.

Example 1: An inmate enters the hospital on April 5 and is discharged on April 7. An application is submitted on April 7. While the application is being processed, the inmate re-enters the hospital on April 10 and is discharged on April 15. The application is approved on April 16. Both the April 5–7 and April 10–15 inpatient hospital stays can be covered under the application submitted on April 7.

Example 2: A pregnant inmate has a pregnancy due date of December 15 and is enrolled in the BadgerCare Plus Prenatal Program with an end date of December 31. The pregnant inmate enters the hospital on December 10 and is discharged on December 11. An application is submitted on December 14 because she was admitted for the delivery of the baby. The application is approved for the December 10 and 11 inpatient hospital stays.

For inmates who have already had their eligibility verified and who may have another hospital admission at a later point during the year, not all information will need to be verified (e.g., citizenship, identification). Income will always have to be verified. Any information that needs to be verified will be determined by EM CAPO as the application is being processed.

3.6.3 Huber Law

Huber Law prisoners who are released from jail for the purpose of attending to the needs of their families can become eligible for BadgerCare Plus if they:

- Intend to return to the home, and
- Continue to be involved in the planning for the support and care of the minor children.

Huber Law prisoners who are released for a purpose other than attending to the needs of their families are not eligible for BadgerCare Plus. They should be considered absent parents.

*This page last updated in Release Number: 16-01
Release Date: 02/15/2016
Effective Date: 02/15/2016*

4 Citizenship and Immigration Status

[View History](#)

4.1 U.S. CITIZENS AND NATIONALS

[4.1.1 Child Citizenship Act](#)

[4.1.2 Compact of Free Association States](#)

All U.S. citizens and U.S. nationals are entitled to apply for and receive BadgerCare Plus if they provide documentation of their citizenship and identity and meet all other eligibility requirements.

A U.S. citizen is anyone who:

1. Was born in the United States, the Commonwealth of Northern Mariana Islands, Puerto Rico, Guam or the U.S. Virgin Islands.
2. Was born to a U.S. citizen who was living abroad.
3. Is a naturalized U.S. citizen.

A U.S. national is anyone who was born in American Samoa (including Swain's Island). The Independent State of Samoa (also known as Western Samoa) is not part of American Samoa, therefore individuals from this country are not U.S. nationals.

4.1.1 Child Citizenship Act

The Child Citizenship Act (CCA) of 2000 amended the Immigration and Naturalization Act (INA) to provide derivative citizenship to certain foreign-born children of U.S. citizens. This applies to individuals who were under 18 years old on February 27, 2001 and anyone born since that date. The children included in the act are:

- Adopted children meeting the two year custody requirement
- Orphans with a full and final adoption abroad or adoption finalized in the U.S.
- Biological or legitimated children
- Certain children born out of wedlock to a mother who naturalizes

The CCA provides that foreign-born children who meet the conditions below automatically acquire U.S. citizenship on the date the conditions are met. They are not required to apply for a certificate of naturalization or citizenship to prove U.S. citizenship. These conditions are that the child:

- Has at least 1 parent who is a U.S. citizen (whether by birth or naturalization),
- Is under 18 years of age,
- Has entered the U.S. as a legal immigrant,
- If adopted, has completed a full and final adoption; and,
- Lives in the legal and physical custody of the US citizen parent in the U.S.

Adopted children automatically become U.S. citizens if the children meet all the above conditions and were:

- a. **Adopted under the age of 16**, and has been in the legal custody of and has resided with the adopting parent or parents for at least two years.
- b. **Adopted while under the age of 18**, and has been in the legal custody of and has resided with the adopting parent or parents for at least two years and is a sibling of another adopted child who is under 16.
- c. **Orphans adopted while under the age of 16**, who have had their adoption and [immigration status](#) approved by the USCIS (Form I-171, "Notice of Approval of Relative Immigrant Visa Petition"). These children need not have lived with the adoptive parents for two years.
- d. **Orphans adopted under the age of 18**, who have had their adoption and immigration status approved by the USCIS, and are siblings of another adopted child who is under the age of 16. These children need not have lived with the adoptive parents for two years.

4.1.2 Compact of Free Association States

Persons from the Compact of Free Association States are not considered U.S. citizens or nationals. The Compact of Free Association States include the Republic of the Marshall Islands, the Federated States of Micronesia and the Republic of Palau.

Citizens of the Compact of Free Association States (CFAS) have a special status with the US that allows them to enter the country, work here and acquire an **SSN** without obtaining an immigration status. They are not eligible for BadgerCare Plus, unless they have obtained a qualifying immigration status. Those CFAS citizens who do not have one of the immigration statuses listed in 4.3 may qualify for BadgerCare Plus Emergency Services only.

*This page last updated in Release Number: 08-07
Release Date: 09/10/08
Effective Date: 09/10/08*

[View History](#)

4.2 DOCUMENTING CITIZENSHIP AND IDENTITY

[4.2. Documenting Citizenship and Identity](#)

[4.2.1 Covered Programs](#)

[4.2.1.1 Exempt Populations](#)

4.2.2 Reserved

4.2.3 Reserved

[4.2.4 Hierarchy of Documentation](#)

[4.2.5 Agencies Paying for Documentation](#)

[4.2.6 Policy For Special Populations](#)

[4.2.7 Situations which require Special Documentation Processing](#)

[4.2.7.1 Person Add](#)

[4.2.7.2 Presumptive Eligibility/Express Enrollment \(EE\)](#)

[4.2.7.3 Individuals Without Verification and Affect on Household Eligibility](#)

[4.2.7.4 Child Citizenship Act 2000](#)

[4.2.7.5 Non-citizens](#)

[4.2.7.6 Individuals in Institutional Care Facilities](#)

The Federal Deficit Reduction Act of 2005 requires persons applying for or receiving Medicaid (MA), BadgerCare Plus, or Family Planning Only Services (*FPOS*) benefits, who have declared that they are a U.S. citizen, to provide documentation of their U.S. citizenship and identity.

Agencies must comply with the BadgerCare Plus requirement to document citizenship and identity in order for the State to obtain Federal matching funds. As part of on-going DHS quality assurance initiatives, periodic quality control reviews will be done on randomly selected cases throughout the state to monitor agency compliance. Cases will be examined to determine if proper documentation was used to verify citizenship/identity and if the proper verification code was used. The Department will work with non-compliant agencies to achieve compliance.

Any document used to establish U.S. citizenship must show either a birthplace in the U.S., or that the person is otherwise a U.S. citizen. In addition, any document used to establish identity must show identifying information that relates to the person named on the document. For a list of all the allowable documentation, see the [Acceptable Citizenship and Identity Documentation](#).

If an individual has provided proof of citizenship in a state other than WI, the IM worker can either request that the individual resubmit the documentation or request and obtain a copy or electronic copy of the original documentation reviewed by the other state to keep on file in WI.

Agencies may accept citizenship and identity documents from a woman whose last name has changed due to marriage or divorce if the documentation matches in every way with the exception of the last name. If there is any doubt, the agency may request that the individual provide an official document verifying the change such as a marriage license or divorce decree. If an individual has changed his or her first and last name, he or she must produce documentation from a court or governing agency documenting the change.

Applicants who are otherwise eligible and are only pending for verification of citizenship and identity must be certified for health care benefits, within the normal *application* processing timeframe (30 days from the *filing date*), as long as the *applicant* has notified the worker that he or she is taking steps to obtain the necessary documentation or has asked for the worker's assistance to obtain it.

The applicant will have 95 days after the request for verification to provide the requested documentation. If the requested verification is not provided by the end of the 95 days, the eligibility will be terminated with Adverse Action notice, unless the eligibility worker believes a

4.2 Documenting Citizenship and Identity

good-faith effort is being made by the applicant/member and the worker chooses to extend the good-faith period. This 95 day period applies to applications, reviews and person adds. An individual can only receive one 95 day good-faith effort period in his or her lifetime.

Once the citizenship and identity requirement is met, it need not be applied again, even if the person loses Medicaid at some point and later re-applies. A person should ordinarily be required to submit evidence of citizenship and identification only once, unless other information is received causing the evidence to be questionable.

Note: Do not re-verify identity for a person who has had his or her identity verified through the signing of a Statement of Identity for Children Under 18 Years of Age, F-10154 ([English](#)) ([Spanish](#)).

Documentation submitted by the applicant or member to satisfy the requirement must be maintained in the case record.

See [Process Help Chapter 68.1](#) for tools that IM workers can use to assist clients and applicants in meeting this requirement.

4.2.1 Covered Programs

The citizenship and identity documentation requirement covers all non-exempt applicants and members of:

- BadgerCare Plus
- Medicaid
- Katie Becket

Note: Eligibility for Katie Becket is determined by Division of Long Term Care staff, therefore they will be ensuring citizenship and identity verification.

- Tuberculosis-related Medicaid (TB MA) and,
- Wisconsin Well Woman Medicaid

Note: TB and [WWW](#) Medicaid eligibility is not determined in [CWW](#) , therefore it is important to ensure that citizenship and identity verification is done only once.

4.2.1.1 Exempt Populations

The following populations are exempt from the citizenship and identity documentation requirement:

- Anyone currently receiving Social Security Disability Insurance (SSDI).
- Anyone who is currently receiving Supplemental Security Income (SSI) benefits.
- Anyone currently receiving Medicare.
- Anyone currently receiving Foster Care (Title IV-E and Non IV-E)
- Anyone currently receiving Adoption Assistance
- Anyone applying for or receiving BadgerCare Prenatal Program benefits.
- Anyone who has ever been eligible for Wisconsin Medicaid or BadgerCare Plus as a Continuously Eligible Newborn (CEN)

Former SSI and Medicare Recipients

States cannot consider individuals who received Medicare or SSI in the past to be exempt. An individual is not required to be a citizen to receive these benefits. Since SSA does not share information regarding the reason benefits were lost, it is not possible to determine if the termination was due to citizenship status or not.

Note: Confirm the receipt of SSI, SSDI, and Medicare through SOLQ or DXSA.

Note: Qualified providers who conduct BadgerCare Plus express enrollment determinations must not apply the citizenship and identification documentation requirement to persons seeking eligibility through express enrollment. Persons determined eligible for BadgerCare Plus through express enrollment are not subject to the documentation requirement until they file a formal application with the local Income Maintenance Agency.

4.2.2 Reserved

4.2.3 Reserved

4.2.4 Hierarchy of Documentation

The list of valid documents used to verify citizenship and identity is divided into five levels in accordance with federal regulations. Level 1 consists of documents of the highest reliability and can prove both citizenship and identity. Levels 2 through 4 consists of documents that can prove citizenship only with Level 2 being the most reliable and Level 4 the least reliable. Level 5 consists of documents that can prove identity only. Applicants and members must provide documentation from the highest level available that can be obtained during the reasonable opportunity period.

If an individual needs to verify citizenship and/or identity at the point of application or renewal he or she should try to fulfill the requirement with proof he or she already has available. If an applicant/member contacts the agency, work with him or her to check Documentation Levels 1 through 5 to determine if anything on the list is readily available to the applicant/member. If an applicant/member was born in Wisconsin, use the online Birth Query to verify citizenship.

In certain circumstances the agency can authorize payment of documentation for an applicant/member. See the [4.2.5](#), Agencies Paying for Documentation.

Level 1 - Evidence of Citizenship and Identity

Primary evidence documents both citizenship and identity. Primary evidence of citizenship and identity is the most reliable way to establish that the person is a U.S. citizen. If an individual presents documents from level 1, no other information is required; however, relatively few BadgerCare Plus applicants and members may be able to provide documents from this group.

Level 2 - Evidence of Citizenship

Secondary evidence of citizenship is the next most reliable way to establish someone is a US citizen. Many BadgerCare Plus applicants and members will be able to present documents from level 2 during the reasonable opportunity period and should be encouraged to do so. Note, however, that a document from this group is evidence of U.S. citizenship only and must be accompanied by evidence of identity.

Note: Completing an on-line birth query (level 2 documentation) can be done for all persons born in Wisconsin. Enter tran code MNOS on *CARES* mainframe screen, hit enter, then F2. There is no cost to the agency to use this method of verification.

Level 3 - Evidence of Citizenship

Third level evidence of U.S. citizenship is acceptable and may be presented by applicants and members who are unable to obtain level 1 or level 2 evidence during the reasonable opportunity period. As with level 2 evidence, a document from this group is evidence of U.S. citizenship only and must be accompanied by evidence of identity.

Level 4 - Evidence of Citizenship

Fourth level evidence of U.S. citizenship is acceptable evidence of the lowest reliability. While most BadgerCare Plus applicants and members will be able to present documents at this level, they should do so only if unable to obtain evidence of citizenship from the other levels during the reasonable opportunity period. As with second and third level evidence, a document from this group is evidence of U.S. citizenship only and must be accompanied by evidence of identity.

Level 5 - Evidence of Identity

Level 5 documentation can only be used to verify identity. Documentation of citizenship from levels two through four must be accompanied by evidence of the applicant's or member's identity from Level 5.

The applicant may provide three or more corroborating documents, such as a marriage license, divorce decree, high school or college diploma, property deed/title, death certificate, or employer

ID card, to prove identity. This option can only be used if the applicant submitted level 2 or 3, not level 4, citizenship documentation. The applicant may not use a document that was also used for citizenship verification.

Naturalized Citizens

Naturalized citizens must provide level 1 or 2 citizenship documentation. The Citizenship Affidavit is also available for this population if no document from level 1 or 2 is available. This group cannot use level 3 or 4 documentation.

4.2.5 Agencies Paying for Documentation

The worker can authorize payment for a birth certificate from the state where the applicant was born and/or a WI State ID if an applicant/member:

- Has no documentation from Levels 1-5;
- Needs either an out of state birth certificate and/or has no identity documentation; and
- Requests financial assistance.

Note: If a member has obtained and already paid for his or her own documentation and later asks the IM agency for reimbursement of those costs, the IM agency should not provide reimbursement. If an individual has requested and paid for documentation before applying but does not yet have the documentation, do not confirm program eligibility for this individual. Eligibility can only be granted once the individual receives documentation and provides it to the agency.

If an individual was born in Wisconsin and not found in the Wisconsin online birth query, agencies may authorize payment for a WI birth certificate to verify citizenship.

IM agencies should pay for a birth certificate or state ID card before using the "Special Populations" option ([4.2.6](#)). If there is an opportunity to obtain a document that meets federal guidelines then that should be pursued.

However, when an applicant/member lacks any identity documentation needed to apply for a birth certificate or lacks any citizenship documentation to be able to apply for an ID card, it is appropriate to consider using the Written Affidavit for citizenship and/or "Special Populations Policy."

In order to obtain birth certificates or state ID cards for applicants/members, agencies need to follow the process outlined in Chapter ([68.2.5](#)) of Process Help.

4.2.6 Policy For Special Populations

4.2 Documenting Citizenship and Identity

It is expected that all non-exempt individuals requesting or receiving BadgerCare Plus provide acceptable documentation to verify citizenship and identity from the federally approved Levels 1 through 5 at application or review. However, certain special populations may be particularly disadvantaged with regard to providing the required documentation. For some persons within a special population, it will be allowable to accept other documents besides those listed in Levels 1-5, once it is determined that the person is unable to produce any Level 1-5 documentation.

This policy only applies when it is determined that an individual within a special population is in a situation where he or she does not have the ability to obtain citizenship or identity documentation from Level 1-5. This policy should be used with discretion and only when an individual has no other means of meeting the requirement.

Examples of individuals in special populations include, but are not limited to, persons who:

- Are physically or mentally incapacitated and whose condition renders them unable to provide necessary documentation.
- Are chronically homeless and whose living arrangement makes it extremely difficult to provide the necessary documentation.
- Are minors.
- Have religious beliefs that prevent them from securing the documentation.

There are two ways for individuals in special populations to meet the citizenship and identity documentation requirement:

1. Present other documents besides those listed in Levels 1-5 to meet the requirement as long as the document meets the general documentation requirement stated here:

"Any document used to establish U.S. citizenship must show either a birthplace in the U.S. or that the person is otherwise a U.S. citizen. Any document used to establish identity must show identifying information that relates to the person named on the document."

Some examples of documents that could be used to establish citizenship for special populations as long as the document shows a birthplace in the U.S. or that the person is otherwise a U.S. citizen are:

- Hospital "souvenir" birth certificate

- Baptismal certificate
- Native American documentation

Below are examples of documents that could be used to establish identity for special populations as long the document shows some identifying information (e.g., name, address, telephone number, etc.) that relates to the individual:

- Social Security Card
- Driver education course completion certificate
- School record or transcript
- Credit card with signature
- Voter registration materials
- Permanent Resident card

Example 1: Due to their religious practices, an Amish family is not able to present a birth certificate for their child because the child was not born in a traditional hospital setting and no record of the child's birth exists within the state system. In addition, the child is home schooled so there is no school identification card to present for identification verification. However, the family is able to produce a signed letter from their church leader that states the child's birth place and birth date. This document can be used to satisfy the citizenship and identification requirement under the policy for Special Populations.

2. The newly developed Statement of Citizenship and/or Identity for Special Populations form ([F-10161](#)) can be used to meet the new requirement only when no other documentation is available from Levels 1-5 or item #1 above.

This form can be completed by a related or unrelated individual who knows the applicant/member, an *authorized representative*, an IM Agency worker, a worker for a housing agency who is aware of the individual's living situation, a BadgerCare Plus provider for a minor, etc. Additional requirements concerning the [F-10161](#) are as follows:

- The person completing the form attesting to another person's citizenship must be a US citizen.
- IM agencies are not required to verify the citizenship of the person signing the form.
- Do not accept a form attesting to the citizenship of another individual when you know the person completing the form is not a US citizen.

Example 2: A 15 year old minor female applies for the Family Planning Only Services program. She does not have a copy of her birth certificate, but because she was born in Wisconsin, the IM worker is able to complete an online birth query to verify her citizenship. The applicant does not have a driver license. She does not have a school ID because the school district in which she lives does not issue a school identification card. Further, she does not have nor is she able to provide any other acceptable document from Levels 1-5. In this case, an F-10161 can be signed by a Family Planning Only Services program provider on the behalf of a minor female to verify her identity and meet the federal requirement.

Note: An F-10161 can be signed by the authorized representative of an individual who is not able to procure any other documents on his or her own.

While an IM worker is obligated to assist an applicant or member who asks for help in meeting the citizenship and identity requirement, this does not necessarily mean the IM worker must sign the F-10161. The signatory to the F-10161 must know and be able to truthfully attest to the applicant/member's citizenship or identity. If an IM worker can do this for an applicant/member, then he or she may sign the form.

Maintain copies of any documents secured under this temporary policy in the case record. Enter Case Comments to document why this policy was used and note whether the F-10161 or another document was used to verify citizenship and identity.

Note: An individual who met the citizenship requirement by using documents obtained under the Special Populations policy or by using the [F-10161](#) has complied with the federal requirement and is not required to provide other documentation at his/ her next review.

If you are aware of an individual who meets the special population category outlined above and whose BadgerCare Plus application has been denied or eligibility has ended because of his or her inability to provide acceptable documentation, contact the individual to see if the Special Populations policies may be applied. See Documentation Level 7 [Acceptable Citizenship and Identity Documentation](#).

4.2.7 Situations Which Require Special Documentation Processing

4.2.7.1 Person Add

A person being added to a case is subject to the verification requirement at the time of his or her application. Inform the applicant of the documentation requirement and give him or her the "reasonable opportunity period" to comply. Do not grant eligibility for the individual until he/she has submitted valid documentation. If documentation is not received timely, deny Medicaid for that individual only. Do not require other non-exempt household members to submit citizenship or identification documentation until their next review.

4.2.7.2 Presumptive Eligibility/Express Enrollment (EE)

Qualified providers who conduct BadgerCare Plus presumptive eligibility/express enrollment determinations must not apply the citizenship and identification documentation requirement to persons seeking presumptive eligibility. Persons determined presumptively eligible for BadgerCare Plus are not subject to the documentation requirement until they file a formal application with the local Income Maintenance agency.

4.2.7.3 Individuals Without Verification and Affect on Household Eligibility

IM workers should not delay an individual household member's eligibility when awaiting another household members' citizenship or identity verification. The individual pending for citizenship/identity should be counted as part of the group when determining eligibility for other group members. See [Process Help Chapter 68.2](#) for processing instructions.

4.2.7.4 Child Citizenship Act 2000

Certain foreign-born individuals have derivative U.S. citizenship as a result of the Child Citizenship Act (CCA). Within the context of the BadgerCare Plus citizenship verification requirement, this means that for any applicant or member claiming citizenship through the CCA, IM workers should not request documentation for that person. In these cases, IM workers need to acquire documentation proving the citizenship and identity of at least one U.S. citizen parent. The parent's U.S. citizenship is the basis for the child receiving derivative citizenship.

For persons who meet the citizenship verification requirement through the means allowed in the CCA, this is considered level 2 evidence. Therefore this counts for citizenship only and the individual needs to provide another document to verify identity. The code <CA> should be used in the BadgerCare Plus Citizenship Verification field.

See [4.1.1 Child Citizenship Act of 2000](#)

4.2.7.5 Non-citizens

As a reminder, do not request or require citizenship and identity documentation from individuals who have not declared that they are citizens. Non-citizens who apply for IM programs are not subject to this policy. Legal non-citizens are subject to the verification process through **SAVE** and undocumented non-citizens do not have any status that can be verified. Undocumented non-citizens can apply for Emergency Medicaid or BadgerCare Plus Prenatal Program and should not be subject to the citizenship verification policy.

When an individual who had legal non-citizen status subsequently gains US Citizenship, this is recorded in SAVE. Therefore SAVE can be used to verify these individuals' citizenship. The verification result from SAVE will be used to verify these individuals' citizenship. The verification result from SAVE will be "individual is a US Citizen". Please consult [Operations Memo 04-10](#), for instructions on using SAVE. Use the <SV> code in the Medicaid Citizenship verification field when using SAVE for this population. These individuals do still need proof of identity since the SAVE verification is considered to be Level 2 citizenship documentation.

4.2.7.6 Individuals in Institutional Care Facilities

Disabled individuals in institutional care facilities may have their identity attested to by the facility director or administrator when nothing else is available. Use the Statement of Identity for Persons In Institutional Care Facilities ([F-10175](#)) for this purpose. A medical institution can be, but is not limited to, skilled nursing facilities (SNF), intermediate care facilities (ICF Intermediate Care Facility), institutions for mental disease (*IMD* Institute for Mental Disease), and hospitals.

*This page last updated in Release Number: 13-02
Release Date: 10/25/13
Effective Date: 10/01/13*

[View History](#)

4.3 IMMIGRANTS

[4.3.1 Public Charge](#)

[4.3.2 Immigration and Naturalization Service Reporting](#)

[4.3.3 Continuous Presence](#)

[4.3.4 Immigration Status Chart](#)

[4.3.5 Iraqis and Afghans With Special Immigrant Status](#)

[4.3.5.1 Counting Refugee Related Income](#)

[4.3.5.2 Refugee Medical Assistance](#)

Immigrants are persons who reside in the U.S., but are not U.S. citizens or nationals. The immigrants described below, who apply for BadgerCare Plus and meet all eligibility requirements, are entitled to receive BadgerCare Plus benefits.

1. A refugee admitted under *INA* Section 207. A refugee is a person who flees his or her country due to persecution or a well-founded fear of persecution because of race, religion, nationality, political opinion, or membership in a social group. An immigrant admitted under this refugee status may be eligible for BadgerCare Plus even if his or her *immigration status* later changes.
2. An asylee admitted under *INA* Section 208. Similar to a refugee, an asylee is a person who seeks asylum and is already present in the U.S. when he or she requests permission to stay. An immigrant admitted under this asylee status may be eligible for BadgerCare Plus even if his or her immigration status later changes.

3. An immigrant whose deportation is withheld under INA Section 243(h) and such status was granted prior to April 1, 1997, or an immigrant whose removal is withheld under INA Section 241(b)(3) on or after April 1, 1997. An immigrant admitted under this status may be eligible for BadgerCare Plus even if his or her immigration status later changes.

4. A Cuban/Haitian entrant. An immigrant admitted under this Cuban/Haitian entrant status may be eligible for BadgerCare Plus even if his or her immigration status later changes.

Haitians paroled into the U.S. through the Haitian Family Reunification Parole Program are considered Cuban/Haitian entrants.

5. An American Indian born in Canada who is at least 50 percent American Indian by blood or an American Indian born outside the U.S. who is a member of a federally recognized Indian tribe.

6. **Lawfully admitted for permanent residence under INA 8 USC 1101 et seq.

7. **Paroled into the U.S. under INA Section 212(d)(5).

8. **Granted conditional entry under immigration law in effect before April 1, 1980 [INA Section 203(a)(7)].

9. **An immigrant who has been battered or subjected to extreme cruelty in the U.S. and meets certain other requirements.

10. **An immigrant whose child has been battered or subjected to extreme cruelty in the U.S. and meets certain other requirements.

11. **An immigrant child who resides with a parent who has been battered or subjected to extreme cruelty in the U.S. and meets certain other requirements.

12. Victims of a severe form of trafficking in accordance with 107(b)(1) of the Trafficking Victims Protection Act of 2000 (P.L. 106-386).

**If these immigrants lawfully entered the U.S. on or after August 22, 1996, they must also be one of the following:

- a. Lawfully residing in Wisconsin and an honorably discharged veteran of the U.S. Armed Forces
- b. Lawfully residing in Wisconsin and on active duty (other than active duty for training) in the U.S. Armed Forces

- c. Lawfully residing in Wisconsin and the spouse, unmarried dependent child, or surviving spouse of a person described in one of the first two criteria
- d. An Amerasian
- e. Resided in the U.S. for at least five years since his or her date of entry (see [Section 4.3.3 Continuous Presence](#)), or

Beginning October 1, 2009, the following no longer have to wait five years to be eligible for full-benefit Medicaid and BadgerCare Plus:

- Children younger than 19 years old
- Young adults younger than 21 years old residing in an *IMD*
- Pregnant women who are either:
 - Lawfully admitted for permanent residence (*CARES* TCTZ Code #1 in the Immigration Status Chart [below](#)),
 - Lawfully present under Section 203(a)(7) (Code #3 in the Immigration Status Chart below),
 - Lawfully present under Section 212(d)(5) (Code #6 in the Immigration Status Chart below), or
 - Who suffer from domestic abuse and are considered to be a battered immigrant (Code #16 in the Immigration Status Chart below)

This policy applies to both persons in existing open cases and new applicants. Women have the five-year ban lifted when their pregnancy is verified and continues for an additional 60 days after the last day of pregnancy and through the end of the month in which the 60th day occurs.

In addition, if children younger than 19 years old, young adults younger than 21 years old residing in an *IMD*, and pregnant women who are legally present in the U.S. are under any of the non-immigrant statuses listed in the table below, they may also qualify for BadgerCare Plus if otherwise eligible.

<i>USCIS</i> Class of Admission Code or Section of the Federal Law Citation Authorizing Class	
Description	Class of Admission Code or Section of Law Citation
Aliens currently in temporary resident status pursuant to section 210 or 245A of the Act.	S16, S26, W16, W25, W26, W36 or 8 CFR 103.12(a)(4)(i)
Aliens currently under Temporary Protected Status (TPS) pursuant to section 244 of the Act. Child accompanying or following to join a K-3 alien.	8 CFR 103.12(a)(4)(ii)
Family Unity beneficiaries pursuant to section 301 of Pub. L.	8 CFR 103.12(a)(4)(iv)

101-649. (These are the spouses and unmarried children of individuals granted temporary or permanent residence under Section 210 or 245A above.)	
Aliens currently under Deferred Enforced Departure (DED) pursuant to a decision made by the President.	8 CFR 103.12(a)(4)(v)
Aliens currently in deferred action status pursuant to Service Operations Instructions at OI 242.1(a)(22).	8 CFR 103.12(a)(4)(vi)
Aliens who are the spouse or child of a United States citizen whose visa petition has been approved and who have a pending application for adjustment of status	8 CFR 103.12(a)(4)(vii)
Legal non-immigrants from the Compact of Free Association states (Republic of the Marshall Islands, the Federated States of Micronesia and the Republic of Palau) who are considered permanent non-immigrants.	NA
An alien who is the fiancée or fiancé of a U.S. citizen entering solely to conclude a valid marriage contract.	K-1
Child of K-1	K-2
Spouse of a U.S. citizen who is a beneficiary of a petition for status as the immediate relatives of a U.S. citizen (I-130).	K-3
Child accompanying or following to join a K-3 alien.	K-4
Parent of an alien classified SK3 or SN3	N-8
Child of N-8 or of an alien classified SK1, SK2, SK4, SN1, SN2, SN4.	N-9
Temporary worker to perform work in religious occupations.	R1
Spouse and children of R1	R2
An alien who is in possession of critical reliable information concerning a criminal organization or enterprise, is willing to supply or has supplied such information to Federal or State law enforcement authorities or a Federal or State court; and whose presence in the United States the Attorney General determines is essential to the success of an authorized criminal investigation or the successful prosecution of an individual involved in the	8 U.S.C. 1101(a)(15)(S)(i)

criminal organization or enterprise	
An alien who the Secretary of State and the Attorney General jointly determine is in possession of critical reliable information concerning a terrorist organization, enterprise, or operation; is willing to supply or has supplied such information to Federal law enforcement authorities or a Federal court; will be or has been placed in danger as a result of providing such information; and is eligible to receive a reward from the State Department.	8 U.S.C. 1101(a)(15)(S)(ii)
An alien who is the spouse, married and unmarried sons and daughters, and parents of an alien in possession of critical reliable information concerning either criminal activities or terrorist operations.	8 U.S.C. 1101(a)(15)(S)
Individuals who have suffered substantial physical or mental abuse as victim of criminal activity.	U-1
An alien who is the spouse, child, unmarried sibling or parent of the victim of the criminal activity above.	U-2, U-3, U-4, U-5
An alien who are the spouses or children of an alien lawfully admitted for permanent residence and who have been waiting since at least December 2000 for their visa application to be approved.	V-1, V-2, V-3

Immigrants who do not appear in the lists above (e.g., someone with a status of *DACA*) and who apply for BadgerCare Plus and meet all eligibility requirements except for citizenship are entitled to receive BadgerCare Plus Emergency Services only (see [Chapter 39 Emergency Services](#)).

Pregnant immigrants who do not appear in the list above and who apply for BadgerCare Plus and meet the eligibility requirements, except for citizenship, are entitled to receive BadgerCare Plus Prenatal Program benefits (see [Chapter 41 BadgerCare Plus Prenatal Program](#)) and/or BadgerCare Plus Emergency Services (see [Chapter 39 Emergency Services](#)).

Immigration status is an individual eligibility requirement. An individual's immigration status does not affect the eligibility of the BadgerCare Plus Group. The citizen spouse or child of an ineligible immigrant may still be eligible even though the immigrant is not.

Verify immigration status using the procedures in the [SAVE Manual](#).

4.3.1 Public Charge

The receipt of BadgerCare Plus by an undocumented, non-qualifying, or qualifying immigrant or by the children or spouse for whom the individual is legally responsible does not establish the person as a public charge.

Undocumented, non-qualifying, or qualifying immigrants are considered to be a public charge if, while receiving BadgerCare Plus, they are in a medical institution for more than the length of a rehabilitative stay.

Undocumented, non-qualifying, or qualifying immigrants concerned about being considered a "public charge," should be directed to contact the [INS field office](#) to seek clarification of the difference between rehabilitative and other types of institutional stays.

4.3.2 Immigration and Naturalization Service Reporting

Do not refer an immigrant to *INS* unless information for administering the BadgerCare Plus program is needed (for example, if BadgerCare Plus needs to determine an individual's immigration status or an individual's location for repayment or fraud prosecution).

4.3.3 Continuous Presence

Certain non-citizens who arrived in the U.S. on or after August 22, 1996, are subject to a five-year ban on receiving federal benefits (including BadgerCare Plus and Medicaid), other than emergency services. For these immigrants, the five-year ban is calculated beginning on the day on which they gain qualified immigrant status. However, certain applicants who alleged an arrival date in the U.S. before August 22, 1996, and obtained legal qualified immigrant status after August 22, 1996, are not subject to the five-year ban and may be eligible to receive federal BadgerCare Plus enrollment. The immigrants described below, who apply for BadgerCare Plus and meet all eligibility requirements, are entitled to receive BadgerCare Plus benefits:

- A non-citizen who arrived in the U.S. before August 22, 1996, in a legal, but non-qualified, immigration status and changed his or her status to a qualified immigrant on or after August 22, 1996. This individual would not be subject to the five-year ban if he or she remained continuously present from his or her date of arrival in the U.S. until the date he or she gained qualified immigration status.
- A non-citizen who arrived in the U.S. before August 22, 1996, in undocumented status or who overstayed his or her original visa is treated the same as someone who arrived and remained in the U.S. with valid immigration documents. Therefore, if this individual remained continuously present from his or her date of arrival in the U.S. until the date he or she gained qualified immigration status, he or she would not be subject to the five-year ban.
- For those non-citizens who arrived in the U.S. with or without documentation on or after August 22, 1996, or for those whose continuous presence cannot be verified, the five-year ban applies from the date the individual obtained qualified immigrant status.

An individual meets the "continuous presence" test if he or she:

- Did not have a single absence from the U.S. of more than 30 days, or
 - Did not have a cumulative number of absences totaling more than 90 days.

To establish continuous presence, require a signed statement from the *applicant* stating he or she was continuously present for the period of time in question. The signed statement will be sufficient unless a worker believes the information is fraudulent or further information received now indicates that it is questionable.

Below is one example of a signed statement:

I, *first and last name*, hereby declare that I have continuously resided in the United States between the day I arrived in the United States, *date here*, and the date I received qualified alien status, *date here*. I have not left the United States in that time for any single period of time longer than 30 days or for multiple periods totaling more than 90 days.

Applicant/*Authorized Representative* Signature, Date

Verification

Primary verification is done through *SAVE*, which is an automated telephone and computer database system. A worker processing an application can compare the date received from SAVE with the date on the immigration documents presented. The primary verification query via SAVE most likely results in returning the latest date of any qualified alien status update for an individual, not his or her original date of arrival. The only way to obtain an accurate date of arrival for those who do not meet an exemption category and who allege a date of arrival prior to August 22, 1996, is through the secondary verification procedure.

It may be necessary to complete a secondary verification procedure with USCIS, including confirming the date of arrival, in the following situations:

- The applicant does not fall into any of the categories of non-citizens who are exempt from the five-year ban (e.g., refugees, asylees, those with military service).
- An *IM* worker has made an initial or primary verification inquiry using the SAVE database. The information from the inquiry conflicts with information on the applicant's immigration documents or what he or she is telling the IM worker.
- A non citizen applicant tells an IM worker that he or she came to the U.S. prior to August 22, 1996. If he or she arrived in a legal or documented status, the IM worker needs to verify the date of arrival to ensure that the correct alien eligibility rules are being applied.
- SAVE returns the message "Institute Secondary Verification."

- The IM worker finds any questionable information in the initial verification process.

The secondary verification procedure is a manual Document Verification Request and includes two forms, Form G-845S and Form G-845 Supplement. These two forms must be submitted together in order to obtain the accurate U.S. arrival date. When sending the forms, include any photocopies of immigration documents presented. Although USCIS maintains a sub-office in Milwaukee, this office does not process these requests. Send the forms to the following address:

US Citizenship and Immigration Services
ATTN: Immigration Status Verifier
10 West Jackson Blvd.
Chicago, IL 60604

An Immigration Status Verifier will research the alien's records and complete the response portion of the verification request.

Note: An applicant who has provided documentation of his or her qualifying immigrant status is considered eligible, pending verification from INS.

Consult the [SAVE manual](#) for more information.

Undocumented Non-Citizens

In cases in which it is known that the applicant originally arrived in the U.S. in undocumented status, do not attempt to verify his or her status with the USCIS. Undocumented immigrants do not have any official documentation regarding their date of arrival. Therefore, if a worker needs to establish a date of arrival for a qualified immigrant who originally arrived as an undocumented immigrant prior to August 22, 1996, alternative methods need to be used. In such cases, the applicant must provide at least one piece of documentation that shows his or her presence in the U.S. prior to August 22, 1996. This may include pay stubs, a letter from an employer, lease or rent receipts, or a utility bill in the applicant's name.

Example 1: The legal status conferred on a non-citizen by immigration law—Toshi entered the U.S. February 2, 2004, with qualified immigrant status. She is applying for BadgerCare Plus in February 2008. The IM worker should first determine if she is in one of the immigrant categories exempt from the five-year ban. If Toshi is not exempt, then she must wait five years before qualifying for BadgerCare Plus. She can be enrolled in BadgerCare Plus after February 2, 2009.

Example 2: Shariff arrived as a student in June 2002. On June 5, 2006 he was granted asylum. The five-year ban does not apply because asylees are exempt from the ban. Secondary verification is not necessary. Shariff is eligible to be enrolled in BadgerCare Plus if he meets other financial and non-financial criteria.

Example 3: Katrin entered the U.S. March 3, 1995, and gained qualified immigrant status June 20, 1995. She is applying for BadgerCare Plus in February 2008. She is a qualified immigrant who entered the U.S. prior to August 22, 1996. There is no need to apply the five-year ban. She is eligible for BadgerCare Plus if she meets other financial and non-financial criteria.

Example 4: Juan entered the U.S. as an undocumented immigrant on April 1, 1996. He applied for BadgerCare Plus on February 1, 2008. His immigration status changed to lawful permanent resident on March 3, 2005. He has signed a self-declaration stating he remained continuously present in the U.S. between April 1, 1996, and March 3, 2005. Additionally, Juan provided a copy of a lease showing a date prior to August 1996. He is eligible for BadgerCare Plus if he meets other financial and non-financial criteria.

Example 5: Elena entered the U.S. on July 15, 1999, on a temporary work visa and obtained qualified immigration status on October 31, 2004. She applied for BadgerCare Plus February 1, 2008, and has been in the U.S. for over five years. Elena is not in one of the immigrant categories exempt from the five-year ban. Therefore, the five-year ban would have to be applied since Elena's original entry date is after August 22, 1996. The five-year clock starts from the date she obtained qualified immigration status, so she would be able to apply for BadgerCare Plus after October 31, 2009.

Example 6: Tomas entered the U.S. on April 8, 1996, on a visitor's visa. He obtained qualified alien status on September 22, 2003. Tomas applied for Medicaid on May 5, 2008. The IM worker completed primary verification and USCIS responded with the date of entry as September 22, 2003, since that was the last updated date on his status. The IM worker needs to confirm with the applicant that this is the original date he arrived in the U.S. Tomas explained that he arrived in 1996; therefore, the IM worker needs to conduct secondary verification. USCIS responds and confirms that the original date of arrival was April 8, 1996. Additionally, the IM worker needs to confirm that the applicant was continuously present between April 8, 1996, and September 22, 2003. Tomas signs a self-declaration confirming this and is found eligible. If the IM worker had used September 22, 2003, as the date of entry in CARES, Tomas would have been incorrectly subject to the five-year ban and not eligible until September 22, 2008.

4.3.4 Immigration Status Chart

CARES TCTZ Code	Immigration Status	Arrived Before August 22, 1996	Veteran* Arrived before August 22, 1996	Arrived on or after August 22, 1996	Veteran* Arrived on or after August 22, 1996	Children under age 19 and pregnant women; Arrived on or
-----------------	--------------------	--------------------------------	---	-------------------------------------	--	---

						after August 22, 1996
01	Lawfully admitted for permanent residence	Eligible	Eligible	Ineligible for 5 years	Eligible	Effective October 1, 2009 Eligible
02	Permanent resident under color of law (PRUCOL)	Ineligible	Ineligible	Ineligible	Ineligible	Ineligible
03	Lawfully present under Section 203(a)(7)	Eligible	Eligible	Ineligible for 5 years	Eligible	Effective October 1, 2009 Eligible
04	Lawfully present under Section 207(c)	Eligible	Eligible	Eligible	Eligible	Eligible
05	Lawfully present under Section 208	Eligible	Eligible	Eligible	Eligible	Eligible
06	Lawfully present under Section 212(d)(5)	Eligible	Eligible	Ineligible for 5 years	Eligible	Effective October 1, 2009 Eligible
07	IRCA (No longer valid)	N/A	N/A	N/A	N/A	N/A
08	Lawfully admitted - temporary	Ineligible	Ineligible	Ineligible	Ineligible	Ineligible
09	Undocumented Alien	Ineligible	Ineligible	Ineligible	Ineligible	Ineligible
10	Illegal Immigrant	Ineligible	Ineligible	Ineligible	Ineligible	Ineligible
11	Cuban/Haitian Entrant	Eligible	Eligible	Eligible	Eligible	Eligible
12	Considered a Permanent Resident by USCIS	Ineligible	Ineligible	Ineligible	Ineligible	Eligible
13	Special agricultural worker under Section	Ineligible	Ineligible	Ineligible	Ineligible	Eligible

	210(A)					
14	Additional special agricultural worker under Section 210(A)	Ineligible	Ineligible	Ineligible	Ineligible	Eligible
15	Withheld deportation - Section 243(h)	Eligible	Eligible	Eligible	Eligible	Eligible
16	Battered Immigrant	Eligible	Eligible	Ineligible for 5 years	Eligible	Effective October 1, 2009 Eligible
17	Amerasian	Eligible	Eligible	Eligible	Eligible	Eligible
18	Foreign Born Native American	Eligible	Eligible	Eligible	Eligible	Eligible
19	Victims of Trafficking	Eligible	Eligible	Eligible	Eligible	Eligible
20	Lawfully Residing	Ineligible	Ineligible	Ineligible	Ineligible	Eligible

* "Veteran" includes certain veterans and active duty servicemen and women, their spouses, dependent children, or certain surviving spouses.

4.3.5 Iraqis and Afghans With Special Immigrant Status

Beginning December 19, 2009, Special Immigrants from Iraq or Afghanistan (Class of Admission Codes SI-1, 2, 3, 6, 7, and 8) are to be treated like they are refugees when determining their eligibility for BadgerCare Plus for as long as they have this Special Immigration status. This policy applies to these immigrants regardless of when they received this status.

Class of Admission Code	Description	CARES Alien Registration Status Code
SI1	Nationals of Iraq or Afghanistan serving as interpreters with the U.S. Armed Forces	Code 04
SI2	Spouses of an SI1	Code 04
SI3	Children of an SI1	Code 04
SI6	Nationals of Iraq or Afghanistan serving as interpreters with the U.S. Armed Forces	Code 04

SI7	Spouses of an SI6	Code 04
SI8	Children of an SI6	Code 04

4.3.5.1 Counting Refugee-Related Income

Refugee Cash Assistance Program payments are not counted as income for BadgerCare Plus. Refugee Cash Assistance is administered by *W-2* agencies and is made available for refugees who do not qualify for *W-2*.

Refugee "Reception and Placement" payments are not counted as income for BadgerCare Plus. Reception and Placement payments are made to refugees during the first 30 days after their arrival in the U.S. Reception and Placement payments are made by voluntary resettlement agencies and may be a direct payment to the refugee individual or family or to a vendor.

4.3.5.2 Refugee Medical Assistance

If an individual does not meet the other eligibility requirements for BadgerCare Plus, he or she may apply for Refugee Medical Assistance, which is not funded by BadgerCare Plus. Refugee Medical Assistance is a separate benefit from BadgerCare Plus but provides the same level of benefits. Refugee Medical Assistance is available only in the first eight months after a special immigrant's date of entry. If it is not applied for in that eight-month period, it cannot be applied for later. Iraqi immigrants may be eligible for Refugee Medical Assistance for eight months, and Afghan immigrants may be eligible for Refugee Medical Assistance for six months.

While *W-2* agencies have contractual responsibility for providing Refugee Medical Assistance, they need to coordinate with economic support agencies to ensure eligibility for all regular BadgerCare Plus subprograms is tested first.

More information about this program is in the [Wisconsin Works \(W-2\) Manual, Section 18.3 Refugee Medical Assistance](#).

Note: The federal Medicaid eligibility for all other refugees admitted under Alien Status Code 04 remains the same.

*This page last updated in Release Number: 16-01
Release Date: 02/15/2016
Effective Date: 02/15/2016*

5 Medical Support and Third Party Liability

[View History](#)

5.1 Medical Support

[5.1.1 Recovery of Birth Costs](#)

[5.1.2 Referral to CSA](#)

Medical Support refers to the obligation that a parent has to pay for his or her child's medical care, either through the provision of health insurance coverage or direct payment of medical bills. The Child Support Agency (CSA) is responsible for establishing medical support orders for some children receiving BadgerCare Plus who have an absent parent. The CSA is also responsible for establishing paternity and establishing medical support obligations for unpaid and ongoing medical support (including recovery of birth costs.)

5.1.1 Recovery of Birth Costs

When the non marital father of the unborn child is not included in the BadgerCare Plus group at the initial eligibility determination he could be held responsible for repayment of birth costs.

5.1.2 Referral to CSA

The IM agency provides the CSA with information vital to opening medical support cases. The IM agency also supplies continuing information, which assists the CSA in providing medical support services. At confirmation, *CARES* automatically sends a referral to the CSA for all BadgerCare Plus applications and person adds that include minors eligible under a Medicaid (T19) Medical Status Code, unless the referral field on the Absent Parent Page is answered 'No'. The information on the Absent Parent Page must be filled out accurately and to the best of the worker's ability, given that detailed questions about absent parents cannot be asked during the application process for health care-only applications. The referral will still be sent to the CSA, even if the absent parent's name is unknown.

Note: A Referral to Child Support Form (DWSW 3080) only needs to be completed when the absent parent page cannot be completed in *CWW*.

Note: While IM agencies are to continue referring the following individuals who are receiving BadgerCare Plus, the CSA's will be determining on their own, which cases will be provided Child Support Services. Not all BadgerCare Plus members will qualify for free Child Support services and be required to cooperate with CSA's.

The following individuals (including minors) for whom BadgerCare Plus is requested or being received, must be referred to the local CSA unless an exception is noted:

1. **Pregnant woman** who is unmarried or married and not living with her husband.

Pregnant women are not required to cooperate with the CSA during the pregnancy and for two months after the end of pregnancy. The woman's eligibility for BadgerCare Plus will continue during this period, regardless of her cooperation.

Exception: Do not refer pregnant women receiving the BadgerCare Plus Prenatal Benefit to CSA.

2. **Child receiving SSI** only if the parent or caretaker relative requests child support services for the child. Do not sanction this parent or [caretaker relative](#) if he or she does not cooperate with the CSA.

3. **Non Marital coparents** when paternity has not been legally established. This includes a non-marital co-parent even when:
 - a. A Statement of Paternity (IMM, Ch. I, Appendix 29g) has been completed,
 - b. Both parents are in the home.

Exception: Do not refer parents to the CSA when both parents are in the home and the father's paternity has been legally established. (Paternity is legally established by a court order or by a Voluntary Paternity Acknowledgment Form signed on or after May 1, 1998 and filed with the Wisconsin Vital Records office.)

Note: If a father's name appears on a Wisconsin Birth Certificate for a child born after 5/11/1998, it means paternity has been established.

4. **Natural or adoptive parent(s)** not living in the household.

Exception: Do not refer to the CSA when the only reason a parent or stepparent is not in the home is because he or she is in the military.

5. **Married natural parents** in the home, but:

- a. Child was born prior to their marriage, **and**
- b. Paternity was not established by court action, or the birth not legitimized after their marriage.

Do not refer the following individuals:

1. Former Foster Care Youths, unless the youth is also the parent of an eligible child in the household.
2. Pregnant women eligible under the BadgerCare Plus Prenatal Program.

*his page last updated in Release Number: 14-03
Release Date: 09/05/14
Effective Date: 09/05/14*

[View History](#)

5.2 Medical Support / CSA Cooperation

[5.2.1 Introduction](#)

[5.2.2 Failure to Cooperate](#)

5.2.1 Introduction

Unless the person is exempt or has *good cause* for refusal to cooperate (see [5.3](#)), each *applicant* /member that is referred, must, as a condition of eligibility, cooperate in:

1. Establishing the paternity of any child born out of wedlock for whom BadgerCare Plus is requested or received, and
2. Obtaining medical support for the applicant and for any child for whom BadgerCare Plus is requested or received.

Cooperation includes any relevant and necessary action to achieve the above. As a part of

cooperation, the applicant may be required to:

1. Provide verbal or written information known to, possessed by, or reasonably obtainable by the applicant.
2. Appear as a witness at judicial or other hearings or proceedings.
3. Provide information, or attest to the lack of information, under penalty of perjury.
4. Pay to the CSA any court ordered medical support payments received directly from the absent parent after support has been assigned.
5. Attend office appointments as well as hearings and scheduled genetic tests.

Note: The applicant or member is only required to cooperate if the child under their care is eligible for benefits funded under Title 19 or is eligible for the Medicaid expansion category of the Children's Health Insurance Program (CHIP). If the child's BadgerCare Plus benefit is funded through any other source such as Title 21 Separate CHIP or GPR (i.e., state funds) the *caretaker relative* is not required to cooperate and can not be sanctioned for non cooperation. Check the Medical Status codes (See [51.1](#)) to determine funding source. The CSA will monitor the child's BadgerCare Plus funding source.

5.2.2 Failure to Cooperate

The CSA determines if there is non-cooperation for individuals required to cooperate. The IM agency determines if good cause exists (see [5.3](#)). If there is a dispute, the CSA makes the final determination of cooperation. The member remains ineligible until he or she cooperates, establishes good cause, or cooperation is no longer required.

The following individuals are not sanctioned for non cooperation:

1. Pregnant women,
2. Minors, and
3. Parents or caretaker relatives while the family is in a BadgerCare Plus Extension.

5.3 Claiming Good Cause

For a pregnant woman, failure to cooperate cannot be determined prior to the end of the month in which the 60th day after the termination of pregnancy occurs.

Note: If the local CS agency determines that a parent is not cooperating because court ordered birth costs are not paid, the parent or caretaker is not sanctioned.

Example: Mary, a disabled parent, is applying for BadgerCare Plus for her and her son, Michael. She refuses to cooperate in obtaining medical support for Michael. Mary meets all other non-financial and financial criteria for BadgerCare Plus and EBD Medicaid.

Mary is not eligible for EBD Medicaid or BadgerCare Plus, because she will not cooperate in obtaining medical support for Michael. Even though Mary has not cooperated in obtaining medical support for Michael, he remains eligible for BadgerCare Plus.

*this page last updated in Release Number: 13-02
Release Date: 10/25/13
Effective Date: 10/01/13*

[View History](#)

5.3 CLAIMING GOOD CAUSE

5.3.1 Claiming Good Cause Introduction

Any parent or other *caretaker relative* who is required to cooperate in establishing paternity and obtaining medical support may claim *good cause*. He or she must do the following:

- Specify the circumstance that is the basis for good cause.
- Corroborate the circumstance according to the evidence requirements in [Section 5.3.5 Evidence](#).

5.3.2 Notice

The *IM* agency must provide a Good Cause Notice ([DWSP 2018](#)) to *applicants* and members whenever a child **with an absent parent** is **part of** the BadgerCare Plus **application or** case. The notice describes the right to refuse to cooperate for good cause in establishing paternity and securing medical support.

Note: Good Cause Notices are provided automatically through ACCESS when people apply or complete renewals online, so the requirement for IM workers to furnish the notice directly to them does not apply in these situations. IM agencies must continue to mail a Good Cause Notice to people who apply or complete renewals by mail or by phone.

The IM worker and the parent or caretaker must sign and date the notice (except for when the notice is completed in ACCESS and automatically filed in the *ECF*). The IM worker must then file the original notice in the case record and give the *applicant* or member a copy. The *CSA* refers anyone who wants to claim good cause back to the IM agency for a determination of whether or not good cause exists.

5.3.3 Good Clause Claim

The Good Cause Claim form ([DWSP 2019](#)) must be provided to any BadgerCare Plus parent or caretaker who requests one. It describes the circumstances that support a claim and how to document a claim.

The parent or caretaker must sign and date the claim in the presence of an IM worker or a notary public. The applicant or member's signature initiates the claim.

The original copy is filed in the case record, a copy is given to the parent or caretaker, and a copy is attached to the referral document when a claim is made at application.

A copy of claims must be sent to the CSA within two days after a claim is signed. When the CSA is informed of a claim, they will immediately suspend all activities to establish paternity or secure medical support until notified of your final determination.

5.3.4 Circumstances

The IM agency must determine whether or not cooperation is against the best interests of the child. Cooperation is waived only if one of the following is true:

- The parent or caretaker's cooperation is reasonably anticipated to result in physical or emotional harm to one of the following:
 - **Child.** This means that the child is so emotionally impaired, that his or her normal functioning is substantially affected.
 - **Parent or Caretaker.** This means the impairment is of such a nature or degree that it reduces that person's capacity to adequately care for the child.
- At least one of the following circumstances exists, and it is reasonably anticipated that proceeding to establish paternity or secure support or both would be detrimental to the child:

- The child was conceived as a result of incest or sexual assault.
- A petition for the child's adoption has been filed with a court.
- The parent or caretaker is being assisted by a public or private social agency in deciding whether or not to terminate parental rights and this has not gone on for more than three months.

5.3.5 Evidence

An initial good cause claim may be based only on evidence in existence at the time of the claim. There is no limit to the age of the evidence. Once a final determination is made, including any fair hearing decision, any subsequent claim must be based on new evidence.

The following may be used as evidence:

- Birth certificates or medical or law enforcement records that indicate that the child may have been conceived as a result of incest or sexual assault.
- Court documents or other records that indicate that a petition for the adoption of the child has been filed with a court.
- Court, medical, criminal, child protective services, social services, psychological school, or law enforcement records that indicate the alleged father or absent parent might inflict physical or emotional harm on the member or the child.
- Medical records that give the emotional health history and present emotional health status of the member or the child.
- A written statement from a mental health professional indicating a diagnosis of or prognosis on the emotional health of the member or the child.
- A written statement from a public or private social agency that the agency is assisting the parent to decide whether or not to terminate parental rights.
- A sworn statement from someone other than the member with knowledge of the circumstance on which the claim is based.
- Any other supporting or corroborative evidence.

When a claim is based on emotional harm to the child or the member, the IM agency must consider all of the following:

- Person's present emotional state
- Person's emotional health history
- Intensity and probable duration of the emotional impairment
- Degree of cooperation required
- Extent of the child's involvement in the paternity or the support enforcement activity to be undertaken.

If the member submits only one piece of evidence or inclusive evidence, you may refer him or her to a mental health professional for a report relating to the claim.

When a claim is based on his or her undocumented statement that the child was conceived as a result of incest or sexual assault, it should be reviewed as one based on emotional harm.

The IM agency must conduct an investigation when a claim is based on anticipated physical harm and no evidence is submitted.

The member has 20 days, from the date the claim is signed, to submit evidence. The IM agency, with supervisory approval, may determine that more time is needed.

There must be at least one document of evidence, in addition to any sworn statements from the member.

The IM agency should encourage the provision of as many types of evidence as possible and offer any assistance necessary in obtaining necessary evidence.

When insufficient evidence has been submitted:

1. The member must be notified, and the specific evidence needed must be requested.
2. The IM agency must advise that person on how to obtain the evidence, and
3. The IM agency must make a reasonable effort to obtain specific documents that are not reasonably obtainable without assistance.

If the parent or caretaker continues to refuse to cooperate or the evidence is still insufficient, a 10-day notice must be sent informing the parent or caretaker that, if no further action is taken within 10 days from the notification date, good cause will not be found and that he or she may first:

- Withdraw the claim and cooperate, or
- Exclude allowable individuals, or
- Request a hearing, or
- Withdraw the application or request that the case be closed.

If no option above has been taken when the 10 days have expired, the IM worker will deny BadgerCare Plus to the applicant or disenroll the member from BadgerCare Plus. The sanctions remain in effect until there is cooperation or until it is no longer required.

5.3.6 Investigation

The IM agency must investigate all claims based on anticipated physical harm both when the claim is credible without corroborative evidence and when such evidence is not available.

Good cause must be granted when both the member's statement and the investigation satisfies the worker that he or she has good cause.

Any claim must be investigated when the member's statement, together with any corroborative evidence, does not provide a sufficient basis for a determination.

In the course of the investigation, neither the IM agency nor the CSA may contact the absent parent or alleged father without first notifying the member of the agency's intention. Once notified, the parent or caretaker has 10 days from the notification date to do one of the following:

- Present additional supporting or corroborative evidence of information so that contact is unnecessary.
- Exclude allowable individuals.
- Withdraw the application or request that the case be closed.
- Request a hearing.

If the 10 days have expired and no option has been taken, the IM agency will deny BadgerCare Plus to the applicant, and the sanctions shall remain in effect until there is cooperation or until it is no longer an issue.

5.3.7 Determination

The IM staff must determine whether or not there is good cause. This should be done within 45 days from the date a claim is signed. The time may be extended if it is documented in the case record that additional time is necessary because:

- The IM agency cannot obtain the information needed to verify the claim within the 45 days, or
- The parent or caretaker does not submit corroborative evidence within 20 days.

The good cause determination and all evidence submitted should be filed in the case record along with a statement on how the determination was reached.

If there is no evidence or verifiable information available that suggests otherwise, it must be concluded that an alleged refusal to cooperate was, in fact, a case of cooperation to the fullest extent possible.

If the parent or caretaker is cooperating in furnishing evidence and information, do not deny, delay, or discontinue BadgerCare Plus pending the determination.

If a fair hearing is requested on a good cause determination, BadgerCare Plus certification is continued until the decision is made.

The 45-day period for determining good cause is not used to extend an eligibility determination. The 30-day limit on processing an application is still a requirement.

The IM worker must notify the applicant or member in writing of the final determination and of the right to a fair hearing and send the CSA a copy. The CSA may also participate in any fair hearing.

5.3.8 Good Cause Found

When good cause is granted, the IM worker must direct the CSA to not initiate any or to suspend all further case activities.

However, when the CSA's activities, without the member's participation, are reasonably anticipated to not result in physical or emotional harm, the IM agency must:

1. First notify the person of the determination and the proposed directive to the CSA to proceed without his or her participation.
2. The person has 10 days from the notification date to:
 - a. Exclude allowable individuals, or
 - b. Request a hearing, or
 - c. Withdraw the application or request that the case be closed.
3. At the end of the 10 days, direct the CSA to proceed if no option was taken. The CSA may decide to not proceed based on its own assessment.

The IM agency determination to proceed without the member's participation must be in writing. Include your findings and the basis for the determination. File it in the case record.

5.3.9 Good Cause Not Found

When good cause is not granted, the IM agency must notify the parent or caretaker. It must be stated in the notice that he or she has 10 days from the notification date to do one of the following:

- Cooperate.
- Exclude allowable individuals.
- Request a hearing.
- Withdraw the application or request that the case be closed.

If the 10 days have expired and no option has been taken, the IM agency must deny BadgerCare Plus to the applicant or terminate the member's BadgerCare Plus eligibility. The sanctions remain in effect until there is cooperation or until it is no longer an issue.

5.3.10 Review

The IM agency does not have to review determinations based on permanent circumstances. Review good cause determinations that were based on circumstances subject to change at redetermination and when there is new evidence.

The parent or caretaker must be notified when it is determined that good cause no longer exists. It must be stated in the notice that he or she has 10 days from the notification date to do one of the following:

- Cooperate.
- Exclude allowable individuals.
- Request that the case be closed.
- Request a hearing.

If the 10 days have expired and no option has been taken, the IM agency must deny the individual's BadgerCare Plus eligibility. The sanctions remain in effect until there is cooperation or until it is no longer an issue.

*This page last updated in Release Number: 16-01
Release Date: 02/15/2016
Effective Date: 02/05/2016*

[View History](#)

5.4 Cooperation Between IM & CSA

[5.4.1 Information](#)

[5.4.2 BadgerCare Plus Discontinued](#)

[5.4.3 Failure to Cooperate](#)

[5.4.4 Fraud](#)

The relationship between the IM agency and the CSA requires ongoing cooperation.

5.4.1 Information

The IM agency provides the CSA with information vital to opening medical support cases. The IM agency also supplies continuing information, which assists them in providing medical support services. Therefore, the CSA may request information from the IM agency in addition to that included in the referral and as contained in the case record.

CARES automatically shares information with **KIDS** so it is important to enter the data accurately.

5.4.2 BadgerCare Plus Discontinued

The CSA is notified through CARES when BadgerCare Plus is discontinued.

5.4.3 Failure to Cooperate

The CSA will determine if non-cooperation occurs. KIDS notifies CARES when an individual refuses or fails to cooperate. The IM Agency must then review eligibility.

5.4.4 Fraud

When the CSA has knowledge of possible fraud, they will refer the case back to the IM agency. For example, if in the process of collecting support, the CSA establishes that a parent is in fact not absent, the CSA will give that information to the IM agency for appropriate action (IMM, Ch. III, Public Assistance Fraud Program).

*This page last updated in Release Number: 07-01
Release Date: 10/29/07
Effective Date: 02/01/08*

[View History](#)

5.5 Third Party Liability

[5.5.1 TPL Cooperation](#)

[5.5.2 TPL Cooperation Requirements](#)

[5.5.3 TPL Good Cause Claim](#)

[5.5.4 Assignment Process](#)

Third Party Liability (TPL) refers to the obligation that a third party (not Wisconsin BadgerCare Plus program or the BadgerCare Plus member), has to pay the bills for a BadgerCare Plus member's medical services. BadgerCare Plus is the payer of last resort for the cost of medical care. This means that if a BadgerCare Plus member also has coverage under a private health insurance plan, that plan is to be billed first for any medical services. BadgerCare Plus then pays any amount remaining after the private insurer has paid what they owe, up to the BadgerCare Plus reimbursement rate.

Another common example of third party liability is when someone receives an insurance settlement resulting from an accident. If BadgerCare Plus paid for any medical services resulting from that accident, the BadgerCare Plus program is to be reimbursed the cost of those medical services from the proceeds of the insurance settlement. Third party payers include health insurers, court ordered medical support and any other third party that has a legal obligation to pay for medical services.

5.5.1 TPL Cooperation

All BadgerCare Plus members must assign to the State of Wisconsin their rights to payments for medical services from third party payers. A member complies with this requirement by signing the *application* form. The assignment includes all unpaid medical support and all ongoing medical support obligations for as long as BadgerCare Plus is received. In addition, BadgerCare Plus members must cooperate in identifying and providing information to assist the State in pursuing third parties who may be liable

to pay for care and services, unless the individual establishes *good cause* for not cooperating. If a member fails to cooperate with TPL requirements he or she could be sanctioned.

5.5.2 TPL Cooperation Requirements

The BadgerCare Plus member must cooperate in providing TPL information unless he or she is exempt or there is good cause for refusing to cooperate. TPL information could include the name and address of an insurance company, insurance policy number, and the name and address of the policy owner.

If an adult refuses, without good cause, to provide health insurance information for themselves, or anyone for whom they are legally responsible and is receiving BadgerCare Plus, the adult is ineligible until he or she cooperates.

Do not sanction the following for non-cooperation:

1. Minors, including minor caretaker relatives.
2. A parent or caretaker relative requesting child support services for a child receiving SSI.
3. Pregnant woman - She may not be sanctioned during the pregnancy, or for two months after the pregnancy has ended, if the TPL source is the absent parent of her child(ren).

5.5.3 TPL Good Cause Claim

When good cause is claimed ([5.3](#)), the IM agency must review the circumstances and decide on whether it is an appropriate claim of good cause. The appropriate entry on the Medical Coverage page in *CWW* regarding the good cause determination must be made, and the reason for the decision must be documented in case comments.

TPL good cause reasons are the same as those for Medical Support.

5.5.4 Assignment Process

At application, the Income Maintenance Agency must give a Notice of Assignment ([DWSW-2477](#)) to each *applicant*. If the applicant refuses to sign this form, the Income Maintenance Agency must complete the lower portion of the form and file it in the case record. This must be done no later than at the time of the interview. The applicant must be given a copy of the notice. Processing a BadgerCare Plus application must not be delayed while waiting for the form to be signed. The member should not be penalized for not signing this form. The original copy must be filed in the case record.

This page last updated in Release Number: 07-01
Release Date: 10/29/07
Effective Date: 02/01/08

[View History](#)

5.6 CASUALTY CLAIM PROCESS (SUBROGATION)

[5.6.1 Reporting Accident or Injury Claims](#)

Casualty claims are those claims for BadgerCare Plus benefits resulting from an accident or injury for which a third party may be liable.

Example 1: Mike receives treatment for injuries suffered when he was hit by a car. The vehicle owner is the third party and may be responsible for reimbursing BadgerCare Plus for those benefits. If Mike is working with an attorney or insurance agency to settle the claim, he is legally obligated to give notification to the *local agency*.

BadgerCare Plus members should report any casualty claims before the case is settled. The BadgerCare Plus ID number of the BadgerCare Plus member, date of the accident, and the insurance company or name of the attorney to bill should be included with the referral.

5.6.1 Reporting Accident or Injury Claims

Members must report any cash award or settlement due to an accident or injury if BadgerCare Plus paid for part or all of the care received as a result of the accident or injury. Members must also report if they have hired an attorney or is working with an insurance agency to settle an accident or injury claim.

1. If a member reports a claim and is receiving SSI or, on the date of the accident or injury was receiving Wisconsin Medicaid or BadgerCare Plus, he or she must report the accident or injury case to the Casualty Recovery Unit at:

WI Casualty Recovery—HMS
5615 Highpoint Dr., Suite 100
Irving, TX 75038-9984

Telephone: (877) 391-7471
Fax: (469) 359-4319

5.6 Casualty Claim Process (Subrogation)

Email: wicasualty@hms.com

Website: www.wicasualty.com/wi/index.htm

Note: If the member is enrolled in an HMO or MCO they must also report the accident or injury to that organization.

2. All other Medicaid members should report in person or **via** phone their local agency and any HMO or MCO that may have provided services, before the case is settled. Members should include the date of the accident and any insurance/attorney information.

This page last updated in Release Number: 16-01

Release Date: 02/15/2016

Effective Date : 02/15/2016

[View History](#)

5.7 Other Health Insurance

The IM Agency should collect insurance coverage information on both the custodial and absent parents and caretakers at *application* , review, person add, or when insurance changes and enter it into the Medical Coverage Page in *CWW* . The *fiscal agent* will complete an insurance search and return verified insurance information through the CWW / MMIS interface.

5.7.1 Policies Not to Report

The following policies should not be entered on the Medical Coverage Page in CWW or reported to the Fiscal Agency on the Health Insurance Information form ([F-10115](#)).

1. HMOs for which the State pays all or part of the premium.
2. Health Insurance Risk Sharing Plans (HIRSP).
3. Medicare (enter in CWW on the Medicare Page).
4. Indian Health Service (IHS). IHS is the exception to the rule that Medicaid is the payer of last resort. For Native Americans who are Medicaid clients, IHS is the payer of last resort. Do not enter these policies on [CARES](#) .
5. Policies that pay benefits only for treatment of accidental injury.
6. Policies that may be described as health insurance, but which pay only weekly or monthly based on the insured's disability.
7. Limited insurance plans that pay only if there is a specific diagnosis, such as cancer policy. Report them only if the person insured has been diagnosed as

having the disease he or she is insured against and if the benefits are assignable.

8. Life Insurance.
9. Other types of insurance types that do not cover medical services.

*This page last updated in Release Number: 14-01
Release Date: 02/07/14
Effective Date: 02/01/14*

6 Social Security Requirements

[View History](#)

6.1 SSN REQUIREMENTS

BadgerCare Plus applicants must provide a **SSN** or be willing to apply for one.

If the caretaker relative is unwilling to provide or apply for the SSN of a minor or 18-year-old, the person who does not have the SSN is ineligible.

Do not require an SSN for:

- a. Continuously eligible newborns.
- b. Pre-adoptive infants living in a foster home.
- c. Non-qualifying immigrants receiving emergency services.
- d. Someone without an SSN and may only be issued one for a valid non-work reason.
- e. Someone who refuses to obtain an SSN because of well-established religious objections*.
- f. Tax dependents or tax filers living outside of the home.

“Well-established religious objections” means that the applicant/member:

1. Is a member of a recognized religious sect or division of the sect, and
2. Adheres to the tenets or teachings of the sect or division of the sect and for that reason is conscientiously opposed to applying for or using a national identification number.

7.1 Health Insurance Conditions of Eligibility

A person who refuses to apply for or use a social security number due to religious beliefs must provide verification from a church elder or other officiant that doing so is against the church doctrine.

*this page last updated in Release Number: 13-02
Release Date: 10/25/13
Effective Date: 10/01/13*

7 Health Insurance Access and Coverage Requirements

[View History](#)

7.1 HEALTH INSURANCE CONDITIONS OF ELIGIBILITY

[7.1.1 Health Insurance Conditions of Eligibility for under Non-MAGI Rules](#)

[7.1.2 Health Insurance Conditions of Eligibility Under MAGI Rules](#)

7.1.1 Health Insurance Conditions of Eligibility under Non-MAGI rules

To prevent the crowd out of private insurance, BadgerCare Plus benefits may be denied or terminated for individuals who have eligibility determined under *non-MAGI* rules and have access to certain employer sponsored health insurance policies when those individuals:

1. Are adult parents and caretaker relatives with household income above 133% of the FPL (through March 31, 2014).
2. Are infants under age 1 with household incomes over 300% of the FPL, children ages 1 through 5 with household incomes over 185% of the FPL and children ages 6 through 18 with household incomes over 150% of the FPL,
3. Are pregnant women eligible under the BadgerCare Plus Prenatal Program at any income level,
4. Are not in an exempt category (see list below) **and**,
5. Do not have a *good cause* reason for failure to enroll in an employer sponsored health insurance plan.

Individuals exempt from the policies related to health insurance access and coverage are:

1. Continuously Eligible Newborns,
2. Children under age 19 who have met a *deductible* (exempt only during the deductible period),

3. Infants less than 1 year old with household income at or below 300% of the FPL,
4. Children ages 1 through 5 (up to age 6) with household income at or below 185% of the FPL,
5. Children ages 6 to 18 with household income at or below 150% of the FPL,
6. Former Foster Care Youth (*FFCY*),
7. Pregnant women, other than those in the BadgerCare Plus Prenatal Program,
8. Parents and caretakers who are blind or disabled (including MAPP Disabled), as determined by the DDB, or through the Presumptive Disability process ([MEH 5.9](#)), and
9. Parents, caretaker relatives, and children who are in an Extension.

BadgerCare Plus Prenatal Program members are subject to different policies related to health insurance coverage. Refer to [\(7.4.1\)](#) [\(7.5\)](#) for the policies regarding the rules for current coverage and dropping coverage under the BadgerCare Plus Prenatal Program.

Access to health insurance includes:

1. Past Access. [\(7.2\)](#)
2. Current Access. [\(7.3\)](#)
3. Coverage. [\(7.4\)](#)
4. Dropped Coverage. [\(7.5\)](#)

IM workers are not responsible for determining current or past access to health insurance. The process will be done through the EVHI database. See [9.9.6.1](#).

7.1.2 Health Insurance Conditions of Eligibility under MAGI rules

To prevent the crowd out of private insurance, BadgerCare Plus benefits may be denied or terminated for individuals who have eligibility determined under *MAGI* rules and have access to certain employer sponsored health insurance policies when those individuals:

1. Are children ages 1 through 5 with household incomes over 191% of the FPL and children ages 6 through 18 with household incomes over 156% of the FPL,
2. Are pregnant women eligible under the BadgerCare Plus Prenatal Program at any income level,
3. Are not in an exempt category (see list below) and,
4. Do not have a *good cause* reason for failure to enroll in an employer sponsored health insurance plan.

Individuals exempt from the policies related to health insurance access and coverage are:

1. Continuously Eligible Newborns,
 2. Children under age 19 who have met a deductible (exempt only during the deductible period),
 3. Infants less than 1 year old with household income at or below 306% of the FPL,
 4. Children ages 1 through 5 (up to age 6) with household income at or below 191% of the FPL,
 5. Children ages 6 to 18 with household income at or below 156% of the FPL,
 6. Former Foster Care Youth,
 7. Pregnant women, other than those in the BadgerCare Plus Prenatal Program,
 8. Parents and caretaker relatives, including those who are blind or disabled (including MAPP Disabled), as determined by the DDB, or through the Presumptive Disability process ([MEH 5.9](#)),
 9. Childless adults, and
 10. Parents, caretaker relatives, and children who are in an Extension.

BadgerCare Plus Prenatal Program members are subject to different policies related to health insurance coverage. Refer to ([7.4.1](#)) ([7.5](#)) for the policies regarding the rules for current coverage and dropping coverage under the BadgerCare Plus Prenatal Program.

Access to health insurance includes:

1. Past Access. ([7.2](#))
2. Current Access. ([7.3](#))
3. Coverage. ([7.4](#))
4. Dropped Coverage. ([7.5](#))

IM workers are not responsible for determining current or past access to health insurance. The process will be done through the EVHI database. See [9.9.6.1](#).

*This page last updated in Release Number: 14-01
Release Date: 02/07/14
Effective Date: 02/01/14*

[View History](#)

7.2 PAST ACCESS TO HEALTH INSURANCE

[7.2.1 Introduction](#)

[7.2.1.1 The 80 Percent Past Access Test](#)

[7.2.1.2 The 9.5 Percent Past Access Test](#)

[7.2.2 Good Cause for "Past Access Test" under Non-MAGI Rules](#)

[7.2.3 Good Cause for "Past Access Test" under MAGI Rules](#)

7.2.1 Introduction

Beginning July 1, 2012, there are two Past Access policies in effect:

- The 80% Past Access Test.
- The 9.5% Past Access Test.

The 80% Past Access Test policies applies to non-exempt children (See [7.1](#)). The 9.5% test applies to adult parents and caretakers until March 31, 2014. After April 1, 2014, parents and caretakers are no longer subject to a Past Access Test.

7.2.1.1 The 80 Percent Past Access Test

Children and any BadgerCare Plus Prenatal Program members who had access to health insurance, including access due to a *qualifying event*, in the twelve months prior to the application or renewal date are not eligible for BadgerCare Plus benefits if the access was through the current employer of an adult family member who is currently living in the household and,

1. The access was to a *HIPAA* health insurance plan through a current employer for which the employer paid at least 80% of the premium, or through the State of Wisconsin's health care plan (regardless of plan type, or premium amount contributed by the employer); and
2. The *applicant* is a child under age 19 and child is not exempt; **and**
3. There is no *good cause* reason for not signing up for the coverage.

The child or BadgerCare Plus Prenatal Program member is ineligible for BadgerCare Plus for twelve calendar months from the date the health insurance would have begun.

Example 1: Marilyn applied for BadgerCare Plus in April 2014 for herself and her children, ages 10 and 8; they have family income that exceeds 156% of the FPL. She could have enrolled in a family health insurance plan through her current employer in October 2013, and her employer pays 80% of the premium for that plan. Marilyn didn't sign up because she felt the premiums, co-payments and deductibles would be unaffordable. If she had signed up, coverage would have begun in December 2013.

Since Marilyn did not sign up for employer-provided coverage within the last twelve months when it was available, and she does not have good cause. Her children are ineligible for BC + through November 2014, 12 months from the date the coverage would have begun, unless they become exempt during that time. Marilyn is not eligible because her income is over the 100% FPL limit for the parent and caretaker coverage

group.

7.2.1.2 The 9.5% Past Access Test

Note: The 9.5% Past Access Test will no longer be effective beginning April 1, 2014.

Non-exempt parents and caretakers over age 18 with household incomes over 133% of the FPL who had access to health insurance, including access due to a qualifying event, in the twelve months prior to the application or renewal date, are not eligible for BadgerCare Plus benefits if the access was through the current employer of an adult family member who is currently living in the household and,

- The individual could have enrolled in the employer's plan under the current coverage period at any time in the past 12 months prior to the application or renewal date,
- The cost of coverage for an employee-only plan does not exceed 9.5% of the monthly household income, and
- There is no good cause reason for not signing up for the coverage.

When an employed parent or caretaker has been determined to have had past access, the individual's spouse will also be considered to have past access if the employer offers a plan that would provide coverage to the spouse, such as employee + spouse or employee + family coverage.

Non-pregnant, non-disabled parents and caretaker relatives with household income above 150% of the FPL will not be eligible for BadgerCare Plus benefits if they had past access to a State Employee's health care plan, regardless of the amount of the premium. Non-pregnant, non-disabled parents and caretakers with access to state employee health insurance, who have household income between 133% and 150% FPL, are only ineligible for BadgerCare Plus if the employee-only premiums are not more than 9.5% of household income.

Example 2: Joe and his wife, Mary, apply for BadgerCare Plus for themselves and their 3 children on July 2, 2012. Their income is 145% of the FPL. Joe works for ABC Company. ABC Company offers an employee-only plan as well as a family plan. Joe's cost for the employee-only plan is less than 9.5% of the household's countable income. The last open enrollment period to sign up for the employer sponsored insurance was October 1, 2011 through October 31, 2011. The plan coverage period is January 1, 2012 through December 31, 2012.

Since Joe could have enrolled in the past 12 months and could have had coverage under the current coverage period, and the premiums would have been less than 9.5% of the family's income, he is ineligible. Since the employer offers a family plan that would cover Mary, she is also ineligible. Children under age 19 are not subject to the

9.5% access tests so the children's eligibility is not affected.

7.2.2 Good Cause for 80% and 9.5% "Past Access Test" under Non-MAGI Rules

Good cause reasons for failure to enroll in an employer sponsored health insurance plan in the 12 months prior to application or renewal are:

1. Discontinuation of health insurance benefits by the employer;
2. During the time period when the employee failed to enroll in the health insurance coverage, one or more members of the individual's family was covered through:
 - a. A private health insurance policy; **or**
 - b. Medicaid, or BadgerCare Plus;

And no one in the Test Group at that time was eligible for:

- BadgerCare,
 - BadgerCare Plus with a household income above 150% of the FPL,
 - If the failure to enroll occurred on or after July 1, 2012, BadgerCare Plus with household income above 133% of the FPL,
 - BadgerCare Plus Extension, **or**
 - BadgerCare Plus as a Pregnant Woman (not including the BadgerCare Plus Prenatal Program).
3. The employment ended, **or**
 4. Any other reason determined by DHS as a good cause reason. Local agencies must contact the DHS CARES Call Center for approval before granting good cause for any reason not stated above.

Example 3: Olivia applied for BadgerCare Plus in January 2012 for herself and her children. Although it was determined that she had access to employer sponsored health insurance in August of 2011 (past access), she has a good cause exemption because she and her children were enrolled in BadgerCare Plus from July 2011 through November 2011 and the family income at that time was only 120% of the FPL.

7.2.3 Good Cause for the 80% "Past Access Test" Under MAGI Rules

7.3 Current Access to Health Insurance

Good cause reasons for failure to enroll in an employer sponsored health insurance plan in the 12 months prior to application or renewal are:

1. Discontinuation of health insurance benefits by the employer;
2. During the time period when the employee failed to enroll in the health insurance coverage, one or more members of the individual's family was covered through:
 - a. A private health insurance policy; **or**
 - b. Medicaid, or BadgerCare Plus;

And no one in the Test Group at that time was eligible for:

- BadgerCare Plus with an assistance group income above 156% of the FPL,
 - BadgerCare Plus Extension, **or**
 - BadgerCare Plus as a Pregnant Woman (not including the BadgerCare Plus Prenatal Program).
3. The employment through which the child is insured ended, **or**
 4. Any other reason determined by DHS as a good cause reason. Local agencies must contact the DHS CARES Call Center for approval before granting good cause for any reason not stated above.

*This page last updated in Release Number: 14-01
Release Date: 02/07/14
Effective Date: 02/01/14*

[View History](#)

7.3 CURRENT ACCESS TO HEALTH INSURANCE

7.3.1 Introduction

Beginning July 1, 2012, there are two Current Access policies in effect:

- The 80% Current Access Test.
- The 9.5% Current Access Test.

The 80% Current Access Test policies applies to non-exempt children (See [7.1](#)). The 9.5% test applies to adult parents and caretakers until March 31, 2014.

7.3.2 The 80 Percent Current Access Test

Children and BadgerCare Plus Prenatal Program members with access to health insurance, including access due to a *qualifying event*, through an employed family member who is currently living in the household are not eligible for BadgerCare Plus benefits if:

1. The access is to a *HIPAA* health insurance plan through a current employer for which the employer pays at least 80% of the premium or the State of Wisconsin's health care plan (regardless of plan type, or premium amount contributed by state or local government); **and**
2. The *applicant*/member is a child under age 19 and the child is not exempt; **and**
3. The coverage would begin within three calendar months following:
 - a. The BadgerCare Plus application *filing date*; **or**
 - b. Annual review month; **or**
 - c. Employment start date

The child or BadgerCare Plus Prenatal Program member who could have been covered by the health insurance plan are ineligible for BadgerCare Plus benefits. Children under 19 years of age can become eligible by meeting a *deductible*. (See [Ch. 17](#))

There are no good cause reasons for not enrolling in a health insurance plan when an individual has current access.

Example 1: Janelle applies for BadgerCare Plus in January for herself and her child. She can enroll in a health insurance plan through her employer in March and her employer pays 80% of the premium. However, since coverage would not begin until May, Janelle does not have "current access" so her child is eligible for BC + until the next eligibility renewal (assuming there are no other changes that resulted in ineligibility). If Janelle's circumstances remain unchanged, her child will be disenrolled at his or her next review because she had "past access". Janelle is not eligible because her income is over the limit for the parent and caretaker coverage group.

Example 2: Bill applies for BadgerCare Plus in January for himself and his family. He can enroll in family health insurance through his employer and the employer pays 80% of the premium. Coverage would start in April. Bill chooses not to sign up because he thinks he will be eligible for BadgerCare Plus. His children are not eligible for BadgerCare Plus because Bill can sign up in this month and coverage would begin within the next three calendar months. Bill is not eligible because his income is over the limit for the parent and caretaker coverage group.

7.3.3. The 9.5 Percent Current Access Test

The 9.5% test applies to adult parents and caretakers until March 31, 2014.

7.4 Current Health Insurance Coverage

For parents and caretakers who are not exempt (See [7.1](#)), an individual with current access to employer sponsored health insurance is not eligible for BadgerCare Plus. An individual has current access to employer sponsored insurance if:

- the individual could enroll in and be covered under the plan in the month for which eligibility is being determined, **and**
- the cost of coverage for the employee-only plan does not exceed 9.5% of the monthly household income.

When an employed parent or caretaker has been determined to have current access, the individual's spouse will also be considered to have current access if the employer offers a plan that provides coverage to the spouse, such as employee + spouse or employee + family coverage.

Non-pregnant, non-disabled parents and caretaker relatives with household income above 150% of the FPL will not be eligible for BadgerCare Plus benefits if they have current access or will have access in the next three months to a State Employee's health care plan, regardless of the amount of the premium. Non-pregnant, non-disabled parents and caretaker relatives with access to state employee health insurance, who have income between 133% and 150% FPL, are only ineligible for BadgerCare Plus if the employee-only premiums are not more than 9.5% of household income.

There are no *good cause* reasons for not enrolling in a health insurance plan when an individual has current access.

*This page last updated in Release Number: 14-01
Release Date: 02/07/14
Effective Date: 02/01/14*

[View History](#)

7.4 CURRENT HEALTH INSURANCE COVERAGE

[7.4.1 Introduction](#)

[7.4.2 The 80% Coverage Test](#)

[7.4.3 The 9.5% Current Coverage Test](#)

[7.4.4 Current Coverage for BadgerCare Plus Prenatal Program](#)

7.4.1 Introduction

Beginning July 1, 2012, there are two Current Coverage policies in effect:

- The 80% Current Coverage Test.

- The 9.5% Current Coverage Test.

The 80% Current Access Test policies applies to non-exempt children (See [7.1](#)). The 9.5% test applies to adult parents and caretakers until March 31, 2014.

7.4.2 The 80% Coverage Test

Certain children who currently have individual or family health insurance coverage through an employed family member currently living in the household AND who meets the following criteria are not eligible for BadgerCare Plus:

1. The child is not exempt from access and coverage policies (See [7.1](#)); and
2. Coverage is provided by an employer; and the employer pays at least 80% of the premium or
3. Coverage is available under the State of Wisconsin employee health plan (regardless of plan type, or premium amount contributed by state or local government).

Example 1: Dave applies for BadgerCare Plus in March for himself and his family. They have income that exceeds 150% of the federal poverty level. He is currently covered by family health insurance through his employer and the employer pays 80% of the premium. His children are not eligible for BadgerCare Plus because they are currently covered. Dave is not eligible because his income is over the income limit for the parent and caretaker coverage group.

Children under 19 years of age who are ineligible due to current coverage can become eligible by meeting a *deductible*. (See [Chapter 17](#))

7.4.3 The 9.5% Current Coverage Test

Note: This policy will only be effective until March 31, 2014.

For parents and caretakers who are not exempt (See [7.1](#)), an individual with current coverage to employer sponsored health insurance is not eligible for BadgerCare Plus.

An individual has current coverage to employer sponsored insurance if:

- The individual is covered under the plan in the month for which eligibility is being determined, **and**
- The cost of coverage for the employee-only plan does not exceed 9.5% of the monthly household income,

or

- Household income is above 150% of the FPL and the coverage is under a State Employee's health care plan, regardless of the amount of the premium.

Note: Non-pregnant, non-disabled parents and caretaker relatives with state employee health insurance coverage, who have household income between 133% and 150% FPL, are only ineligible for BadgerCare Plus if the employee-only premiums are not more than 9.5% of household income.

7.4.4 Current Coverage for BadgerCare Plus Prenatal Program

Pregnant women who are otherwise eligible only for the BadgerCare Plus Prenatal Program because of their inmate or *immigration status* are not eligible for the BadgerCare Plus Prenatal program if they are covered by any *HIPAA* health insurance policy. The plan does not have to be employer sponsored.

*This page last updated in Release Number: 14-01
Release Date: 02/07/14
Effective Date: 02/01/14*

[View History](#)

7.5 RESERVED

*This page last updated in Release Number: 16-01
Release Date: 02/15/2016
Effective Date: 07/14/2015*

[View History](#)

7.6 GOOD CAUSE REASONS FOR DROPPING INSURANCE COVERAGE

Any of the following reasons are considered *good cause* for dropping insurance coverage:

1. The individual was covered by a group health plan that was provided through his or her employer, and the employment ended for a reason other than voluntary termination, unless the voluntary termination was a result of the incapacitation of the individual or because of an immediate family member's health condition.
2. The individual was covered by a group health plan that was provided through his or her employer, but the individual changed employers and the new

employer does not offer health insurance coverage.

3. The individual was covered by a group health plan that was provided through his or her employer, and the individual's employer discontinued health plan coverage for all employees.
4. The individual's coverage terminated due to the death or change in marital status of the policy holder.
5. For BadgerCare Plus Prenatal Program applicants or members only:
 - a. Her coverage was COBRA continuation coverage and the coverage was exhausted in accordance with federal regulations concerning COBRA.
 - b. The insurance does not pay for pregnancy-related services.
 - c. The insurance is owned by someone not residing with the pregnant woman and continuation of the coverage is beyond her control.
 - d. The insurance only covers services provided in a service area that is beyond a reasonable driving distance.
6. Any other reason determined by the department to be a good cause reason.

Example: Joanne applies for BadgerCare Plus in June for herself and her family after being fired from her job. Although it was determined that she had "dropped coverage", she has a good cause exemption because her employment was involuntarily terminated.

When good cause for dropping insurance coverage is approved, begin BadgerCare Plus eligibility the day after the last day of the insurance coverage or the *application* date, whichever is later if the *applicant* applies prior to losing insurance. If the applicant applies after losing insurance, coverage can begin on the day after the last day of insurance if they apply in the same month insurance is lost.

*This page last updated in Release Number: 10-01
Release Date: 02/25/10
Effective Date : 02/25/10*

[View History](#)

7.7 HEALTH INSURANCE PREMIUM PAYMENT (HIPP)

[7.7.1 Introduction](#)

[7.7.2 Cost Effectiveness](#)

[7.7.3 Participation in HIPP](#)

[7.7.4 Cooperation](#)

7.7.1 Introduction

Wisconsin's Health Insurance Premium Payment (*HIPP*) program helps BadgerCare Plus families pay the employee contribution of their employer sponsored insurance. The HIPP program pays the family's share of the monthly premium, co-insurance, and deductibles associated with the family health plan along with any BadgerCare covered services not included in the family health plan through fee-for-service (wrap around).

HIPP will be considered for BadgerCare Plus members when it is cost effective to do so.

In addition to families with employer sponsored health insurance plans, the following BadgerCare Plus families may also be considered for HIPP:

- Farm and other self-employed families
- Members with Self-funded insurance plans

Access to HIPP coverage will be allowed even if single or "plus one" coverage is the only coverage offered by an employer.

Minimum employer contribution requirements will be eliminated and employer-sponsored insurance (ESI) will be based solely on cost effectiveness.

7.7.2 Cost Effectiveness

The HIPP Unit of the *fiscal agent* determines if it is cost effective to buy the employer's insurance rather than enroll the individual in BadgerCare Plus.

The HIPP Unit will identify the cost of wrapping around the Medicaid services with the employer-sponsored plan and then determine cost effectiveness of buy-in on that calculation of cost comparability.

This determination will be done on a per person basis. Thus, in any given BadgerCare Plus group, it may be cost effective to enroll all BadgerCare Plus members or only specific members. For example: it may be cost effective to enroll an adult in HIPP but to keep the children in BadgerCare Plus.

7.7.3 Participation in HIPP

Members participating in HIPP are enrolled in BadgerCare Plus as a secondary insurance. If the employer's health insurance does not cover a service that BadgerCare Plus covers, BadgerCare Plus will cover the cost.

7.7.4 Cooperation

To remain eligible for BadgerCare Plus, the adult whose employer can provide insurance must:

1. Cooperate in providing information necessary to assess cost-effectiveness, and
2. Agree to enroll and actually enroll in the employer's health care plan if the plan is determined to be cost-effective.

Parents may no longer be sanctioned for failing to cooperate with the HIPP program. This policy applies to both current members and new applicants.

*This page last updated in Release Number: 14-02
Release Date: 02/07/14
Effective Date: 02/01/14*

[View History](#)

7.8 ACCESS AND COVERAGE OVERVIEW

[7.8.1 Access and Coverage Overview Prior to January 31, 2014](#)

[7.8.2 Access and Coverage Overview for New Applicants on or After February 1, 2014](#)

[7.8.3 BadgerCare Plus Prenatal Program Access and Coverage Overview](#)

These overviews are intended to be a guide to help determine whether or not a BadgerCare Plus member or *applicant* is subject to the BadgerCare Plus insurance access and coverage requirements.

7.8.1 Access and Coverage Overview Prior to January 31, 2014

To determine whether or not an individual passes BadgerCare Plus insurance access and coverage requirements through January 31, 2014, answer the following questions for each individual within a BadgerCare Plus group.

1. Is the applicant or member pregnant, disabled, a continuously eligible newborn, or a youth exiting out-of-home care?
 - If yes, the applicant or member is not subject to the access and coverage requirements.
 - If no, continue to question #2.
2. Is the member a child younger than 19 years old and currently eligible for BadgerCare Plus because a child's 150 percent *deductible* was met?
 - If yes, the member is not subject to the access and coverage requirements during the deductible period.
 - If no, continue to [question #3](#).

3. Is the member in a BadgerCare Plus Extension?
 - If yes, the applicant or member is not subject to the access and coverage requirements.
 - If no, continue to [question #4](#).

4. Is the applicant or member one of the following:
 - a. An infant younger than 1 year old with household income at or below 300 percent *FPL*
 - b. A child 1 through 5 years old with household income at or below 185 percent FPL
 - c. A child 6 through 18 years old with household income at or below 150 percent FPL
 - If yes, the applicant or member is not subject to the access and coverage requirements.
 - If no, continue to [question #5](#).

5. Is this member a child younger than 19 years old?
 - If yes, continue to [question #6](#).
 - If no, continue to [question #20](#).

6. Does the applicant or member have access to health insurance, including access due to a *qualifying event*, through a current employer or the current employer of an adult member of the BadgerCare Plus test group?
 - If yes, continue to [question #7](#).
 - If no, continue to [question #10](#).

7. Does the employer pay 80 percent or more of the premium?
 - If yes, continue to [question #11](#).
 - If no, continue to [question # 10](#).

8. Is the employer-provided insurance the Wisconsin state employee health plan (regardless of plan type or premium amount contributed by state or local government)?
 - If yes, continue to [question #9](#).
 - If no, continue to [question #10](#).

9. Would the coverage begin in any of the three calendar months after one of the following:
- a. The month of BadgerCare Plus *application filing date*
 - b. The annual review month
 - c. The employment start date
- If yes, the applicant is not eligible for BadgerCare Plus benefits.
 - If no, continue to [question #10](#).
10. Did the applicant or member have access to employer-provided health insurance, including access due to a qualifying event, through a current employer or the current employer of an adult in the BadgerCare Plus test group in the 12 months prior to the application or review date?
- If yes, continue to [question #11](#).
 - If no, continue to [question #14](#).
11. Would the employer have paid 80 percent or more of the premium (at any time in the last 12 months)?
- If yes, continue to [question #13](#).
 - If no, continue to [question #12](#).
12. Would the employer-provided insurance be under the Wisconsin state employee health plan (regardless of plan type or premium amount contributed by state or local government)?
- If yes, continue to [question #13](#).
 - If no, continue to [question #14](#).
13. Did the applicant or member have "*good cause*" for failure to enroll in an employer-sponsored health insurance plan in the 12 months prior to the application (see [Section 7.2.1 Introduction](#))?
- If yes, continue to [question #14](#).
 - If no, the applicant is ineligible for BadgerCare Plus for 12 months from the date the coverage would have begun unless he or she becomes exempt from health insurance/access coverage requirements during that time.

14. Did the applicant or member lose employer-provided health insurance coverage provided through an employer or an employer of an adult BadgerCare Plus test group member in the three calendar months prior to the application?

- If yes, continue to [question #15](#).
- If no, the applicant or member passes the BadgerCare Plus insurance access and coverage requirements.

15. Did the employer pay 80 percent or more of the premium?

- If yes, continue to [question #17](#).
- If no, continue to [question #16](#).

16. Was the employer-provided insurance part of the Wisconsin state employee health plan (regardless of plan type or premium amount contributed by state or local government)?

- If yes, continue to [question #17](#).
- If no, the applicant or member passes the BadgerCare Plus insurance access and coverage requirements.

17. Did the applicant or member have "good cause" for dropping the health insurance (see [Section 7.6 Good Cause Reasons for Dropping Insurance Coverage](#))?

- If yes, the applicant or member passes the BadgerCare Plus insurance access and coverage requirements.
- If no, the applicant or member is ineligible for BadgerCare Plus for three calendar months following the month in which the insurance coverage ended.

18. Is this member's income greater than 133 percent of the FPL?

- If yes, continue to [question #19](#).
- If no, the applicant or member is not subject to the access and coverage requirements.

19. Does the applicant or member have access to health insurance, including access due to a qualifying event, through a current employer or the current employer of an adult member of the BadgerCare Plus test group?

- If yes, continue to [question #20](#).
- If no, continue to [question #24](#).

20. Is the cost of the premium for an employee-only plan offered by the employer more than 9.5 percent of the household income in the month for which you are determining eligibility?

- If yes, continue to [question #21](#).
- If no, continue to [question #23](#).

21. Is the employer-provided insurance the Wisconsin state employee health plan (regardless of plan type or premium amount contributed by state or local government) and is household income over 150 percent of the FPL?

- If yes, continue to [question #22](#).
- If no, continue to [question #24](#).

22. Would the coverage begin in any of the three calendar months after one of the following:

- a. The month of BadgerCare Plus application filing date
- b. The annual review month
- c. The employment start date

- If yes, the applicant is not eligible for BadgerCare Plus benefits.
- If no, continue to [question #24](#).

23. Would the coverage begin in any of the months for which you are determining eligibility and are those months immediately after one of the following:

- a. The BadgerCare Plus application filing date
- b. The annual review
- c. The employment start date

- If yes, the applicant is not eligible for BadgerCare Plus benefits.
- If no, continue to [question #24](#).

24. Did the applicant or member have access to employer-provided health insurance, including access due to a qualifying event, through a current employer or the current employer of an adult in the BadgerCare Plus test group in the twelve months prior to the application or review date?

- If yes, continue to [question #25](#).

- If no, continue to [question #28](#).

25. Was the cost of the premium for an employee-only plan offered by the employer more than 9.5 percent of the household income in the month for which you are determining eligibility?

- If yes, continue to [question #26](#).
- If no, continue to [question #27](#).

26. Was the employer-provided insurance under the Wisconsin state employee health plan (regardless of plan type or premium amount contributed by state or local government) and is the household income over 150 percent of the FPL?

- If yes, continue to [question #27](#).
- If no, continue to [question #28](#).

27. Did the applicant or member have "good cause" for failure to enroll in an employer-sponsored health insurance plan in the 12 months prior to the application (see [Section 7.2.1 Introduction](#))?

- If yes, continue to [question #28](#).
- If no, the applicant is ineligible for BadgerCare Plus 12 months from the date the coverage would have begun, unless he or she becomes exempt during that time.

28. Did the applicant or member lose employer-provided health insurance coverage provided through an employer or an employer of an adult BadgerCare Plus test group member in the three calendar months prior to the application?

- If yes, continue to [question #29](#).
- If no, the applicant or member passes the BadgerCare Plus insurance access and coverage requirements.

29. Was the cost of the premium for an employee-only plan offered by the employer more than 9.5 percent of the household income in the month for which you are determining eligibility?

- If yes, continue to [question #30](#).
- If no, continue to [question #31](#).

30. Was the employer-provided insurance part of the Wisconsin state employee health plan (regardless of plan type or premium amount contributed by state or local government) and is the household income over 150 percent of the FPL?

- If yes, continue to [question #31](#).
- If no, the applicant or member passes the BadgerCare Plus insurance access and coverage requirements.

31. Did the applicant or member have "good cause" for dropping the health insurance (see [Section 7.6 Good Cause Reasons for Dropping Insurance Coverage](#))?

- If yes, the applicant or member passes the BadgerCare Plus insurance access and coverage requirements.
- If no, the applicant or member is ineligible for BadgerCare Plus for three calendar months following the month in which the insurance coverage ended.

7.8.2 Access and Coverage Overview for New Applicants on or After February 1, 2014

To determine whether or not an individual passes BadgerCare Plus insurance access and coverage requirements beginning February 1, 2014, answer the following questions for each individual within a BadgerCare Plus group.

1. Is the applicant or member pregnant, disabled, a continuously eligible newborn, or a youth exiting out-of-home care?
 - If yes, the applicant or member is not subject to the access and coverage requirements.
 - If no, continue to [question #2](#).
2. Is the member a child younger than 19 years old and currently eligible for BadgerCare Plus because a child's 150 percent deductible was met?
 - If yes, the member is not subject to the access and coverage requirements during the deductible period.
 - If no, continue to [question #3](#).

3. Is the member in a BadgerCare Plus Extension?

- If yes, the applicant or member is not subject to the access and coverage requirements.
- If no, continue to [question #4](#).

4. Is the applicant or member one of the following:
 - a. An infant younger than 1 year old with household income at or below 306 percent FPL
 - b. A child 1 through 5 years old with household income at or below 191 percent FPL
 - c. A child 6 through 18 years old with household income at or below 156 percent FPL
 - If yes, the applicant or member is not subject to the access and coverage requirements.
 - If no, continue to [question #5](#).

5. Is this member a child younger than 19 years old?
 - If yes, continue to [question #6](#).
 - If no, continue to [question #9](#).

6. Does the employer pay 80 percent or more of the premium?
 - If yes, continue to [question #8](#).
 - If no, continue to [question # 7](#).

7. Is the employer-provided insurance the Wisconsin state employee health plan (regardless of plan type or premium amount contributed by state or local government)?
 - If yes, continue to [question #8](#).
 - If no, continue to [question #9](#).

8. Would the coverage begin in any of the three calendar months after one of the following:
 - a. The month of BadgerCare Plus application filing date
 - b. The annual review month
 - c. The employment start date
 - If yes, the applicant is not eligible for BadgerCare Plus benefits.
 - If no, continue to [question #9](#).

9. Did the applicant or member have access to employer-provided health insurance, including access due to a qualifying event, through a current employer or the current employer of an adult in the BadgerCare Plus test group in the twelve months prior to the application or review date?
 - If yes, continue to [question #10](#).
 - If no, continue to [question #13](#).

10. Would the employer have paid 80 percent or more of the premium (at any time in the last 12 months)?
- If yes, continue to [question #12](#).
 - If no, continue to [question #11](#).
11. Would the employer-provided insurance be under the Wisconsin state employee health plan (regardless of plan type or premium amount contributed by state or local government)?
- If yes, continue to [question #12](#).
 - If no, continue to [question #13](#).
12. Did the applicant or member have "good cause" for failure to enroll in an employer-sponsored health insurance plan in the 12 months prior to the application (see [Section 7.2.1 Introduction](#))?
- If yes, continue to [question #13](#).
 - If no, the applicant or member is ineligible for BadgerCare Plus for 12 months from the date the coverage would have begun unless he or she becomes exempt from health insurance/access coverage requirements during that time.
13. Did the applicant or member lose employer-provided health insurance coverage provided through an employer or an employer of an adult BadgerCare Plus test group member in the three calendar months prior to the application?
- If yes, continue to [question #14](#).
 - If no, the applicant or member is not subject to the BadgerCare Plus insurance/access coverage requirements.
14. Did the employer pay 80 percent or more of the premium?
- If yes, continue to [question #16](#).
 - If no, continue to [question #15](#).
15. Was the employer-provided insurance part of the Wisconsin state employee health plan (regardless of plan type or premium amount contributed by state or local government)?
- If yes, continue to [question #16](#).

- If no, the applicant or member passes the BadgerCare Plus insurance access and coverage requirements.

16. Did the applicant or member have "good cause" for dropping the health insurance (see [Section 7.6 Good Cause Reasons for Dropping Insurance Coverage](#))?

- If yes, the applicant or member passes the BadgerCare Plus insurance access and coverage requirements.
- If no, the applicant or member is ineligible for BadgerCare Plus for three calendar months following the month in which the insurance coverage ended.

7.8.3 BadgerCare Plus Prenatal Program Insurance Access and Coverage Overview

Use this overview only for the BadgerCare Plus Prenatal Program. The BadgerCare Plus Prenatal Program is for pregnant women who are not eligible for BadgerCare Plus solely due to immigration status or due to being an inmate.

1. Does she have access to health insurance, including access due to a qualifying event, through a current employer or the current employer of an adult member of the BadgerCare Plus test group?
 - If yes, continue to [question #2](#).
 - If no, continue to [question #5](#).
2. Does the employer pay 80 percent or more of the premium?
 - If yes, continue to [question #4](#).
 - If no, continue to [question #3](#).
3. Is the employer-provided insurance the Wisconsin state employee health plan (regardless of plan type or premium amount contributed by state or local government)?
 - If yes, continue to [question #4](#).
 - If no, continue to [question #5](#).
4. Would the coverage begin in any of the three calendar months after one of the following:
 - a. The month of BadgerCare Plus Prenatal application filing date
 - b. The annual review month
 - c. The employment start date
 - If yes, the applicant is not eligible for BadgerCare Plus Prenatal benefits.

- If no, continue to [question #5](#).
5. Did she have access to employer-provided health insurance, including access due to a qualifying event, through a current employer or the current employer of an adult in the BadgerCare Plus test group in the twelve months prior to the application or review date?
- If yes, continue to [question #6](#).
 - If no, continue to [question #9](#).
6. Would the employer have paid 80 percent or more of the premium (at any time in the last 12 months)?
- If yes, continue to [question #8](#).
 - If no, continue to [question #7](#).
7. Would the employer-provided insurance be under the Wisconsin state employee health plan (regardless of plan type or premium amount contributed by state or local government)?
- If yes, continue to [question #8](#).
 - If no, continue to [question #9](#).
8. Did she have "good cause" for failure to enroll in an employer-sponsored health insurance plan in the 12 months prior to application (see [Section 7.2.1 Introduction](#))?
- If yes, continue to [question #9](#).
 - If no, she is ineligible for the BadgerCare Plus Prenatal Program 12 months from the date the coverage would have begun unless she becomes exempt during that time.
9. Is the woman covered by any *HIPAA* health insurance policy?
- If yes, she is ineligible to enroll in the BadgerCare Plus Prenatal Program.
 - If no, continue to [question #10](#).
10. Has the woman lost coverage under a major medical health insurance plan that meets the standards of a HIPAA standard plan in the prior three calendar months?
- If yes, continue to [question #11](#).
 - If no, she passes BadgerCare Plus Prenatal insurance access and coverage requirements.
11. Did she have a "good cause" for losing the major medical health insurance which met the standards of a HIPAA standard plan (see [Section 7.6 Good Cause Reasons for Dropping Insurance Coverage](#))?
- If yes, she passes BadgerCare Plus Prenatal insurance access and coverage requirements.

- If no, she is ineligible for the BadgerCare Plus Prenatal Program for three calendar months following the month the insurance coverage ended.

*This page last updated in Release Number: 15-02
Release Date: 09/02/2015
Effective Date: 02/01/2014*

8 Pregnant Women and Continuously Eligible Newborns

[View History](#)

8.1 PREGNANT WOMEN

Note: This chapter does not apply to pregnant women in the BadgerCare Plus Prenatal Program.

A pregnant woman who is enrolled in BadgerCare Plus stays eligible for:

- The balance of the pregnancy, and
- An additional 60 days after the last day of pregnancy through the end of the month in which the 60th day occurs.

The decision about her eligibility **does not** need to be made prior to **the** termination of **the** pregnancy, but the *application* must be filed before the end of the pregnancy in order for her to remain enrolled as a pregnant woman for the 60 days after the pregnancy ends. If the application is not filed before the end of the pregnancy and the newborn is living with her or she is the caretaker relative of other children under 19, she should be tested as a *caretaker relative* once the pregnancy ends. An application for Express Enrollment does not meet this application test.

If a pregnant woman is covered under the Standard Plan at any time during her pregnancy, she will remain in the Standard Plan while she is eligible as a pregnant woman, regardless of changes in income or other eligibility factors.

A pregnant woman with income over 300 percent of the *FPL* (under *non-MAGI* rules) or 306 percent of the FPL (under *MAGI* rules) at the time of application **when her eligibility is first determined** can become eligible for BadgerCare Plus by meeting a *deductible* (see [Section 17.2 Pregnant Women](#)).

There are no premiums for pregnant women (see [Section 19.1 BadgerCare Plus Premiums](#)).

All pregnant women, except those eligible under the BadgerCare Plus Prenatal Program, may have their eligibility backdated to the first of the month up to three

months prior to the month of application. If a woman is determined to be eligible as a pregnant woman for a backdated month, she remains eligible, even if she is over the income limit for any subsequent months, as long as she is still pregnant.

Example 1: Barb is pregnant and applied for BadgerCare Plus in December with a three-month backdate request. Barb is due in March. Her income was below 306 percent of the FPL for September, but over 306 percent for October, November, December, and ongoing. She met all of the other eligibility criteria. Since she was determined eligible as a pregnant woman for the month of September, the subsequent increase in her income is ignored and she remains eligible for BadgerCare Plus through the end of the month, which is 60 days after the pregnancy ends.

*This page last updated in Release Number: 16-01
Release Date: 02/15/2016
Effective Date: 02/15/2016*

[View History](#)

8.2 CONTINUOUSLY ELIGIBLE NEWBORNS

Newborn children are automatically eligible for BadgerCare Plus from the date of birth through the end of the month in which they turn 1 year old if both the following are true:

1. They are younger than 13 months old.
2. The natural mother was determined eligible in the state of Wisconsin for one of the following programs:
 - a. BadgerCare Plus
 - b. Other full-benefit Medicaid (see [Medicaid Eligibility Handbook Section 21.2 Full-Benefit Medicaid](#))
 - c. Emergency Services BadgerCare Plus
 - d. Emergency Services Medicaid (see [Medicaid Eligibility Handbook Section 34.1 Emergency Services](#))
 - e. BadgerCare Plus Prenatal Program (as a nonqualifying immigrant)

There is no income or resource test for these children while they are eligible under this status; therefore, they are not required to provide any income tax filing information in order for their BadgerCare Plus eligibility to be determined.

Note: Children born to incarcerated mothers will not be eligible as **CENs**. In addition, children born to pregnant minors with family income over 300 percent FPL who were eligible for BadgerCare Plus are not eligible as CENs. This policy only applies through March 31, 2014, because children will no longer be eligible above 300 percent FPL as of April 1, 2014. The natural mother's eligibility could have been determined either prior to the date of delivery or retroactively to cover the date of delivery.

Example: Sasha gave birth on April 15. On June 15, she applied for BadgerCare

Plus. Her eligibility was backdated to March 15. Her infant son is eligible as a CEN from April 15 through April 30 of the following year, the end of the month in which he turns 1 year old.

The newborn child does not receive this automatic eligibility as a CEN if the mother's BadgerCare Plus enrollment is a temporary enrollment through the Express Enrollment program.

A newborn is not required to reside with his or her mother to be eligible as a CEN. This is true even if the newborn is being placed in foster care, adoption, or is residing with a *caretaker relative*. A CEN who no longer resides with his or her mother but still resides in Wisconsin should remain eligible as a CEN through the end of the month in which he or she turns 1 year old.

Through March 31, 2014, the child will be covered under either the Standard or the Benchmark Plan, depending on the plan the mother was covered by at the time of the baby's birth. Effective April 1, 2014, all infants eligible for BadgerCare Plus as a CEN will be covered under the Standard Plan. If the child is enrolled in BadgerCare Plus on or after February 1, 2014, the child will be covered under the Standard Plan upon enrollment. If the child is covered by the Benchmark plan prior to February 1, 2014, the child will transition to the Standard plan effective April 1, 2014.

Anyone who has ever been eligible as a CEN under Wisconsin Medicaid or BadgerCare Plus is exempt from the citizenship and identity documentation requirements.

The CEN will not have to pay premiums and is not subject to the health insurance access/coverage requirements.

*This page last updated in Release Number: 15-02
Release Date: 09/02/2015
Effective Date: 09/02/2015*

9 Verification

[View History](#)

9.1 VERIFICATION

Proof of certain information is required to determine eligibility for BadgerCare Plus.

Mandatory (9.9) and questionable (9.10) items must be verified at *application*, renewal, person addition or deletion, or when there is a change in circumstance that affects eligibility or benefit level. One time only verification items do not need to be re-verified.

Verification means to establish the accuracy of verbal or written statements made by, or about a group's circumstances. Case files or case comments must include documentation for any information required to be verified to determine eligibility or benefit levels.

*This page last updated in Release Number: 07-01
Release Date: 10/29/07
Effective Date : 02/01/08*

[View History](#)

9.2 Application

The time period for processing an application for BadgerCare Plus is 30 days from the date the agency receives the application. For paper applications, this is the date a signed valid application is delivered to the agency or the next business day if it is delivered after the agency's regularly scheduled business hours. For phone applications, this is the date a valid signature is received by the agency. For electronic applications from ACCESS or the Marketplace, this is the next business day if the application is delivered after 4:30 p.m., on a weekend, or on a holiday.

Eligibility should not be denied for failure to provide the required verification until the later of:

- 10th day after requesting verification, or the
- 30th day after the application filing date.

Advise the applicant of the specific verification required. Give the applicant a minimum of 10 calendar days to provide any necessary verification.

If verification is requested more than ten days prior to the 30th day, the applicant must still be allowed 30 days from the application filing date to provide the required verification.

*This page last updated in Release Number: 16-01
Release Date: 02/15/2016
Effective Date: 02/15/2016*

[View History](#)

9.3 Eligibility Renewals

The group's eligibility should not be denied for failure to provide the required verification until the 10th day after requesting verification or the end of the renewal month whichever is later.

Example 1: Fred's eligibility renewal is due in April. He submits a mail-in renewal form on April 10th. The eligibility worker requests verification of his income on April 11th. If the verification is not submitted by April 30th, his eligibility will end on April 30th.

Example 2: Shannon's eligibility renewal was due in June. At [Adverse Action](#) in June a notice was sent to Shannon to let her know her BadgerCare Plus eligibility would end June 30th because she had not yet completed her renewal. A telephone interview was conducted on June 30th. A request for verification, with a July 10th due date, was sent to Shannon. Because the required verification (including signature) was not submitted by July 10th, her eligibility beginning July 1st was denied.

Note: After an individual transitions to MAGI rules, requested verification turned in within 90 days of the renewal due date should be processed as timely. See [Process Help 4.6](#).

*his page last updated in Release Number: 13-02
Release Date: 10/25/13
Effective Date: 10/01/13*
[View History](#)

9.4 Changes

When a change is reported that requires verification, the member must be notified in writing of the specific verification required and allowed a minimum of ten days to provide it.

*This page last updated in Release Number: 07-01
Release Date: 10/29/07
Effective Date: 02/01/08*

[View History](#)

9.5 Documentation

Documentation includes putting an original or copy of a piece of evidence in the case record.

Documentation also includes adding notations to case comments when copying is not possible. Notations must include enough information to verify eligibility, ineligibility, benefit level, and coverage group determinations.

All documentation must be in sufficient detail to permit a reviewer to determine the reasonableness and accuracy of the determination.

Documentation should include enough data to describe the nature and source of the information should any follow up be required. All documentation should be date stamped.

Document in the case comments:

1. Collateral contacts.
2. Observations in home visits.
3. Explanations of conversations.

*This page last updated in Release Number: 13-02
Release Date: 10/25/13
Effective Date: 10/25/13*

[View History](#)

9.6 Collateral contacts

Collateral contacts consists of oral confirmations of circumstances by persons other than food unit (FS) or group (BadgerCare Plus) members. A collateral contact may be made either in person or over the telephone.

While performing a collateral contact:

1. Do not disclose that an individual has applied for public assistance.
2. Do not disclose more information than is absolutely necessary to get the information being sought.
3. Do not disclose any information supplied by the [applicant](#) .
4. Do not suggest that the applicant is suspected of any wrongdoing.

9.6.1 Documenting Verbal Statements and Collateral Contacts

Documentation of collateral contacts must include:

1. Name of collateral contact,
2. Title of Individual,

3. Organization the individual is affiliated with,
4. Address (if no phone, or information obtained in person),
5. Significance to household,
6. Date(s) of contact(s) and when pertinent information was obtained.

*This page last updated in Release Number: 07-01
Release Date: 10/29/07
Effective Date: 02/01/08*

[View History](#)

9.7 Release of information

Someone's written release to get information from a verification source is needed only when the source requires it.

When a source requires a written release:

1. The requirement must be explained to the member.
2. The individual, his or her spouse, or another appropriate adult in the household must sign the necessary release form(s). The forms that may be used are *CARES* -generated or alternate pre-printed *application* forms.

Benefits should be denied, discontinued or reduced only when:

1. The missing verification is necessary to determine eligibility, and
2. The individual is unwilling or unable to provide the verification directly, and
3. The source requires a release, and
4. The individual, his or her spouse or another appropriate adult in the household refuses to sign the release, and
5. The release is the only way the verification can be obtained.

*This page last updated in Release Number: 07-01
Release Date: 10/29/07
Effective Date: 02/01/08*

[View History](#)

9.8 General Rules

1. Avoid over-verification (requiring excessive pieces of evidence for any one item or requesting verification that is not needed to determine eligibility). Do not require additional verification once the accuracy of a written or verbal statement has been established.
2. Do not verify information already verified unless there is reason to believe the information is fraudulent or differs from more recent information. If fraud is suspected, determine if a referral for fraud or for front-end verification should be made ([9.10.1](#)).
3. Do not exclusively require one particular type of verification when various types are adequate and available.
4. Verification need not be presented in person. Verification may be submitted by mail, fax, e-mail, or through another electronic device or through an [authorized representative](#) .
5. Do not target special groups or persons on the basis of race, religion, national origin or migrant status for special verification requirements.
6. Do not require the member to sign a release form (either blanket or specialized) when the member provides required verification.
7. Do not require verification of information that is not used to determine eligibility.

Except for verification of access to employer sponsored health insurance ([9.9.6](#)), the member has primary responsibility for providing verification and resolving questionable information. However, the IM worker must use all available data exchanges to verify information rather than requiring the *applicant* to provide it, unless the information from the data source is not reasonably compatible with what the applicant or member has reported (see Chapter 9.12 Reasonable Compatibility).

Assist the member in obtaining verification if he or she requests help or has difficulty in obtaining it.

Use the best information available to process the *application* or change within the time limit and issue benefits when the following two conditions exist:

1. The applicant/member does not have the power to produce verification, and
2. Information is not obtainable timely even with your assistance.

Do not deny eligibility in this situation, but continue in your attempts to obtain verification. When you have received the verification, you may need to adjust or recover benefits based on the new information. Explain this to the applicant/member when requesting verification.

*This page last updated in Release Number: 15-01
Release Date: 05/15/2015
Effective Date: 05/15/2015*

[View History](#)

9.9 Mandatory Verification Items

[9.9.1 Social Security Number](#)

[9.9.1.1 Newborns](#)

[9.9.1.2 BC + Emergency Services](#)

[9.9.1.3 BadgerCare Plus Prenatal Program](#)

[9.9.2 Immigrant Status](#)

[9.9.3 Pregnancy](#)

[9.9.4 Medical Expenses](#)

[9.9.5 Power of Attorney and Guardianship](#)

[9.9.6 Access to Employer-Sponsored Health Insurance](#)

[9.9.6.1 Employer Verification of Health Insurance \(EVHI\) database](#)

[9.9.6.2 Other Forms of Health Insurance Access Verification](#)

[9.9.7 Tribal Membership](#)

[9.9.8 Pre-Tax Deductions](#)

[9.9.9 MAGI Tax Deductions](#)

The following items must be verified for BadgerCare Plus:

1. [SSN \(9.9.1\)](#)
2. Citizenship and identity ([Chapter 4.2](#))
3. Immigrant status ([9.9.2](#))
4. Pregnancy, if eligibility is based on the pregnancy ([9.9.3](#))

Note: Effective January 1, 2014, pregnancy is no longer required to be verified.

5. Medical expenses (for deductibles only) ([9.9.4](#))
6. Documentation for Power of Attorney and Guardianship ([9.9.5](#))
7. Migrant worker's eligibility in another state ([12.3](#))
8. Income
9. Health insurance access ([9.9.6](#))
10. Health insurance coverage ([Chapter 7](#))
11. Family re-unification plan for child welfare parents ([Chapter 10](#))

12. The placement status of a FFCY ([Chapter 11](#)) on his or her 18th birthday
13. Tribal membership or Native American descent ([9.9.7](#))
14. Pre-tax deductions ([9.9.8](#))
15. MAGI Tax deductions ([9.9.9](#))

Unless determined questionable, self-declaration is acceptable for all other items.

Do not request income verification from health care applicants and members unless the information cannot be obtained through an electronic data source, or information from the data source is not reasonably compatible with what the applicant or member has reported (see section 9.12 Reasonable Compatibility).

9.9.1 Social Security Number

Social security numbers (SSNs) need to be furnished for household members requesting BadgerCare Plus unless they are exempt from the SSN requirement (see [6.1](#)). SSNs are not required from non-applicants, including outside of the home tax dependents and co-filers.

An *applicant* is not required to provide a document or Social Security card. He or she only needs to provide a number, which is verified through the *CARES* SSN validation process.

If the SSN validation process returns a mismatch record, the member must provide the Social Security card or another official government document with the SSN displayed. If an applicant does not yet have an SSN he or she must be willing to apply for one.

Assist the member in applying for an SSN for any group member who doesn't have one (IMM, Ch. I, Part C).

Do not deny benefits pending issuance of an SSN if you have any documentation that an SSN *application* was made. At the next renewal, check to see if an SSN has been issued.

The member should be informed if the SSN validation process indicates another individual is using the same SSN. The member should contact the Social Security Administration and request they conduct an investigation. The IM worker can not provide the member with any information that would identify the individual who is using the member's SSN.

If the Social Security Administration finds that the SSN has been used fraudulently it may:

1. Recommend further action be taken.

and/or

2. Provide the member with the information on the fraudulent action so that the member may pursue action through the legal system.

Verify the SSN only once.

9.9.1.1 Newborns

A parent of a newborn may begin an SSN application on the newborn's behalf while still in the hospital.

Do not require an SSN to be furnished or applied for on behalf of a newborn determined continuously eligible (8.2) for BC +. Accept the mother's statement about the existence and residence of the newborn.

9.9.1.2 BC + Emergency Services

Do not require or verify SSNs of members who receive BadgerCare Plus Emergency Services only ([Chapter 39](#)).

9.9.1.3 BadgerCare Plus Prenatal Program

Women applying for the BadgerCare Plus PP do not need to apply for or provide an SSN. See [41.1 BadgerCare Plus Prenatal](#).

9.9.2 Immigrant Status

A member who indicates he or she is not a citizen must provide an official government document that lists his or her immigrant registration number. Verification of the individual's *immigration status* is done through the Systematic Alien Verification for Entitlement ([SAVE](#)) system. Women applying for BadgerCare Plus Prenatal Program ([Chapter 41](#)) and persons applying for Emergency Services ([Chapter 39](#)) who do not provide proof of immigration status can still qualify for those benefits.

An immigrant that presents documentation of his or her immigrant status and meets all other eligibility criteria is eligible while any secondary verification of immigrant status is taking place.

Do not re-verify immigrant status unless the member reports a change in citizenship or immigrant status.

9.9.3 Pregnancy

Verification of pregnancy is only required until December 31, 2013. Beginning January 1, 2014, verification is no longer required for pregnancy unless the worker has information that contradicts the applicant or member's statement.

Through December 31, 2013, if a woman wants to be considered pregnant for the BadgerCare Plus pregnant women group or the BadgerCare Plus Prenatal Program ([Chapter 39](#)) eligibility determination, documentation from a health care professional attesting to the pregnancy is required. Fetus count and the expected pregnancy end date are not mandatory verification items.

When pregnancy must be verified, acceptable verification sources for pregnancy are:

1. Physician's statement.
2. Physician assistant's statement.
3. Licensed nurse practitioner's statement.
4. A written statement from a registered nurse (RN) working:
 - a. In a Healthy Birth Identification of Pregnancy Project (EDP).
 - b. In a Publicly funded family planning project.
 - c. As a Certified Nurse Midwife.
5. A valid BadgerCare Plus Temporary Enrollment card.

Note: After January 2014, if pregnancy must be verified, the IM worker will no longer be able to use a BadgerCare Plus Temporary Enrollment card as a source of verification, as pregnancy will not be verified for Temporary Enrollment for Pregnant Women.

9.9.4 Medical Expenses

Medical expenses used to meet a *deductible* must be verified. The expense amount, any third party liability amount and date of service must all be verified.

9.9.5 Power of Attorney and Guardianship

Verify power of attorney and any guardianship type as specified by the court. Ask for any documentation regarding durable power of attorney or court-ordered guardianship.

9.9.6 Access to Employer-Sponsored Health Insurance

Verification of access to health insurance is required at the following times, unless the individual has already verified health insurance access within the last 12 months with the same employer:

1. BadgerCare Plus Application and Renewal.

2. Person Add - if adult (age 18 or over) is employed and part of the BadgerCare Plus test group.
3. When an adult (age 18 or over) in the BadgerCare Plus test group gets a new job.
4. When a change is processed causing total household income to exceed the following FPL thresholds:
 - Infants less than 1 year old, 300% of the FPL,
 1.
 - Children ages 1 through 5 (up to age 6), 185% of the FPL,
 - Children ages 6 to 18, 150% of the FPL,
 - Parents and caretakers, 133% of the FPL, **and**
 - Parents and caretakers with access to a Wisconsin state employee's health insurance plan, 150 % of the FPL

Note: Because of changes in income limits, the reporting requirements listed above for parents and caretakers are only effective until March 31, 2014.

Note: Verification of access to insurance when parents' and caretakers' household income exceeds 133% is applied beginning July 1, 2012, when one of the following occurs:

- A new application or program request is submitted,
- New employment is reported,
- The next review/renewal is completed, or
- A parent or caretaker with employment is added to the assistance group.

9.9.6.1 Employer Verification of Health Insurance (EVHI) Database

It is not the client's responsibility to verify access to employer-sponsored health insurance. For the majority of BadgerCare Plus applicants and members the EVHI database will be used to verify insurance access. Information gathered from employers is stored in the database. The verification will be returned based on the employer details entered on the employment page. It will be critical for Income Maintenance workers to enter the correct FEIN number and all other employment details for each employment sequence so that all employers are correctly identified in the EVHI database.

If the employment details are not complete enough to verify access, the applicant will be sent a letter from the State requesting more information and the case will pend.

Example 1: Mary's employer has verified that permanent full-time employees have access to health insurance, however temporary employees do not. Mary did not indicate whether she is a permanent or temporary employee. Since that information is necessary to verify access to health insurance using the database, she will be sent a letter requesting the information.

If the employer has not provided information about the health insurance they offer to their employees, the BadgerCare Plus eligibility will pend and a request will be sent from the State to the employer requesting that the information be provided.

BadgerCare Plus eligibility can pend up to the end of the 30 day application processing period. At that point, regardless of whether the employer has responded or not, eligibility must be confirmed. If the employer has not responded assume there is not access to employer sponsored health insurance.

BadgerCare Plus will not be terminated or denied due to an employer failure to respond to a request for verification of health insurance access. If BadgerCare Plus eligibility begins and an employer later responds to the verification request indicating that health insurance access is available to the employee, BadgerCare Plus eligibility will be terminated with adequate notice of *adverse action*. There will be no overpayment liability for the applicant.

9.9.6.2 Other Forms of Health Insurance Access Verification

Other types of verification can be used to document access to employer sponsored health insurance. If a BadgerCare Plus applicant or member needs medical services, agencies may use other contacts with employers in these situations to speed the verification process. Other forms of verification include:

- EVF-H form
- Employer statement
- Collateral Contact with the employer

9.9.7 Tribal Membership

Tribal members are exempt from paying BadgerCare Plus premiums and may be exempt for certain benefit co-payments. Effective January 1, 2014, tribal members eligible for BadgerCare Plus will also be exempt from co-pays.

To receive these exemptions, verification of tribal membership or descent from a tribal member is required. Verification may be done with a:

- Tribal Enrollment Card
- Written verification or a document issued by the tribe indicating tribal affiliation
- Certificate of degree of Indian blood issue by BIA
- Tribal census document
- Medical record card or similar documentation that specifies an individual is an Indian that is issued by an Indian Health Care provider.

9.9.8 Pre-Tax Deductions

Individuals whose eligibility is determined using MAGI rules can claim pre-tax deductions in order to determine their MAGI taxable income. In order to claim a pre-tax deduction, verification of the amount is required. Verification sources such as pay stubs or other documentation from the individual's employer can serve as acceptable documentation. See [16.3.2](#) for list of pre-tax deductions.

9.9.9 MAGI Tax Deductions

Individuals whose eligibility is determined using *MAGI* rules can claim certain tax deductions from the IRS 1040 Form, regardless of whether or not the individual files taxes. Individuals who claim such deductions must provide proof that the expense is or was incurred. See [16.3.3](#) for a list of tax deductions.

Forms of verification for MAGI tax deductions could include:

- Receipts,
- Bank statements,
- Check stubs, or
- Previous years' tax forms.

*This page last updated in Release Number: 15-01
Release Date: 05/15/2015
Effective Date: 05/15/2015*

[View History](#)

9.10 QUESTIONABLE ITEMS

Information is questionable for BadgerCare Plus when:

1. There are inconsistencies in the group's oral or written statements.
2. There are inconsistencies between the group's claims and collateral contacts, documents, or prior records.
3. The member or his or her representative is unsure of the accuracy of his or her own statements.
4. The member has been convicted of Medicaid or BadgerCare Plus fraud or has legally acknowledged his or her guilt of member fraud.
5. The member is a minor who reports that he or she is living alone. This does not apply to minors applying solely for Family Planning Services.
6. The information provided is unclear or vague.

7. CARES Worker Web (CWW) determines the case meets an automated Error Prone Profile.

9.10.1 Front End Verification

Front-End verification (FEV) is intensive verification of a case by a special unit or worker. Refer a group for FEV only when its characteristics meet a designated profile. See [12.3 FEV Case Application](#) of the Income Maintenance Manual.

*this page last updated in Release Number: 14-03
Release Date: 09/05/14
Effective Date: 09/28/14*
[View History](#)

9.11 Processing Time frame

[9.11.1 Verification Receipt Date](#)

[9.11.2 Positive Actions](#)

[9.11.3 Delay](#)

[9.11.4 Negative Actions](#)

9.11.1 Verification Receipt Date

The verification receipt date is the day verification is delivered to the appropriate Income Maintenance agency or the next business day if verification is delivered after the agency's regularly scheduled business hours.

Income Maintenance agencies must stamp the receipt date on each piece of verification received.

9.11.2 Positive Actions

Begin or continue benefits when:

1. The member provides requested verification within the specified time limits and is otherwise eligible.
2. Requested verification is mandatory, but the member does not have the power to produce the verification and he or she is otherwise eligible. In this situation, the agency must also make an effort to obtain the verification ([9.8](#)).

9.11.3 Delay

Notify the member when the agency is not able to process the *application* within 30 days when:

1. Verification is needed, and
2. The member/*applicant* has the power to produce the verification, and
3. The minimum time period allowed for producing the verification has not passed, and
4. Additional time is needed to produce the verification.

CARES provides a verification checklist, to notify the member of the reason for the delay, the specific verification required, and the date the verification is due.

9.11.4 Negative Actions

Deny or reduce benefits when all of the following are true:

1. The member has the power to produce the verification.
2. The time allowed to produce the verification has passed.
3. The member has been given adequate notice of the verification required.
4. You need the requested verification to determine current eligibility. Do not deny current eligibility because a member does not verify some past circumstance not affecting current eligibility.

*This page last updated in Release Number: 07-01
Release Date: 10/29/07
Effective Date: 02/01/08*

[View History](#)

9.12 Reasonable Compatibility for Health Care

[9.12.1 Programs for Which Reasonable Compatibility Will Apply](#)

[9.12.2 Reasonable Compatibility Thresholds](#)

[9.12.3 Reasonable Compatibility Test](#)

[9.12.4 Determining a Data Exchange-Based Income Amount for the Reasonable Compatibility Test](#)

[9.12.5 Use of Equifax Data for Verification of Income](#)

Agencies may not request verification from health care applicants and members unless the information cannot be obtained through an electronic data source, or information from the data source is not “reasonably compatible” with what the applicant has reported. Information from the data source is “reasonably compatible” if it results in the same eligibility outcome as member-reported information:

- If both the electronic data source and the member-reported information put the individual’s total countable income below a given income threshold, the two data sources are considered to be reasonably compatible and further verification may not be requested or required.
- If the electronic data source puts the individual’s total countable income above a given income threshold, but the member-reported information puts the individual’s total countable income below that same threshold, the two data sources are not reasonably compatible and further verification is required as a condition of eligibility.
- If the member reports income that is above a given threshold, the member-reported income information will be used to deny or terminate health care benefits, regardless of what the outcome would be using information from the electronic data source. In this scenario, verification is not required.

The reasonable compatibility test will only be applied to job earnings that have not otherwise been verified (for example, as part of another program’s verification process). It can only be applied when earnings information is available through the State Wage Information Collection Agency (SWICA) or through Equifax from the Federal Data Services Hub (FDSH).

Unearned income (as defined in Chapter [16.5](#)) will continue to be verified as outlined in this chapter and in the [Process Help Manual, Chapter 44](#). If there is an electronic data source available to use for verifying a type of unearned income, it should be used as verification for that income. If no data source is available, the applicant or member must provide verification of the unearned income.

Self-employment and in-kind job income will continue to be verified as outlined in [Process Help Section 16.4.4 and Chapter 16.2](#).

9.12.1 Programs for Which Reasonable Compatibility Will Apply

The reasonable compatibility test will be performed as part of any eligibility determination for the following categories of BadgerCare Plus:

- BadgerCare Plus based on MAGI rules, with the exception of deductibles
- Family Planning Only Services (FPOS) based on MAGI rules

Populations not subject to an income test (for example, Former Foster Care Youth) will not have a reasonable compatibility test.

9.12.2 Reasonable Compatibility Thresholds

The reasonable compatibility test will apply to each AG for which earned income is reported, has not been already been verified, and for which SWICA and/or Equifax data is available. Because different AGs are subject to different income thresholds, the following thresholds will be used by population to determine whether reported information is reasonably compatible. In some cases, the threshold will be a FPL percent, while in others it will be a fixed dollar amount.

Note: Because different thresholds are used for different populations, individual members of a household or a given AG may pass the reasonable compatibility test while others do not.

Population	Threshold(s)
Adults (MAGS, MAGA and MAGN)	100% FPL
Adults in Extensions with a premium	Premium thresholds: 133, 140, 150, 160, 170, 180, 190, 200, 210, 220, 230, 240, 250, 260, 270, 280, 290, and 300% FPL
Children – under age 1	306% FPL
Children – ages 1 through 5	191% FPL Premium thresholds (unless the child is exempt): 201, 231, 241, 251, 261, 271, 281, 291, and 301% FPL 306% FPL
Children – ages 6 through 18	133% FPL 156% FPL Premium thresholds (unless the child is exempt): 201, 231, 241, 251, 261, 271, 281, 291, and 301% FPL 306% FPL
Pregnant women	306% FPL

FPOS	306% FPL
------	----------

For populations with multiple thresholds, the lowest threshold that is higher than the reported income is used.

Example 1: Fatima is in an extension and reports earnings for a total monthly income of 141% FPL. The reasonable compatibility test would be based on the next highest threshold listed above, which is 150% FPL.

Example 2: Marty and Jen have two sons, Alex (age 9) and Warren (age 4). They apply for BadgerCare Plus and report that Marty has earnings of \$3,750/month. Equifax data is not available. SWICA reports that Marty has earnings of \$3,955/month. For a group size of 4, the reported household income is 189% FPL, while the household income based on SWICA data is 199% FPL. As parents, Marty and Jen are ineligible for BadgerCare Plus based on their reported income of 189% FPL. Each child is subject to a reasonable compatibility test based on the next highest relevant threshold for his age group.

For Alex, at age 9, the reasonable compatibility threshold is 201% FPL. The household's income based on both the reported income and SWICA are below this threshold, so the reasonable compatibility standard is met and no further verification is required for Alex.

For Warren, at age 4, the reasonable compatibility threshold is 191% FPL (the threshold for T19 vs. T21 funding of BadgerCare Plus benefits). The household's income based on reported income is below this threshold, while the household's income based on SWICA is above this threshold. As a result, the amounts are not reasonably compatible and verification must be provided in order for Warren to become eligible.

If the family provides paystubs that show actual monthly income of more than 200% FPL, both children would be subject to a premium based on the income verified by paystubs.

9.12.3 Reasonable Compatibility Test

The reasonable compatibility test is based on whether using member-reported information about earnings and information about earnings from data exchanges results in the same eligibility outcome when all other countable income is taken into account.

Reasonable compatibility will first be tested based on the household's total countable income as reported to the agency or verified through other sources. This test will determine whether the member is required to provide verification of earnings.

If the member-reported earnings amount is not reasonably compatible (based on the household's total reported income), verification of earnings will be required at the same

time that verification is required for unearned income, self-employment, and/or tax deductions.

A second verification request will be required if the initial test leads to a determination of reasonable compatibility but the earnings are no longer reasonably compatible after other income types or deductions have been verified.

If earnings are determined to be reasonably compatible, the amount reported by the member should be used to determine eligibility and premium amounts for health care.

If the earnings are later verified (for example, because verification is required for another program), the verified earnings should then be used to determine eligibility and premium amounts for health care.

In this situation, members are not liable for overpayments because the initial determination was based on income that was reasonably compatible with a data exchange.

Note: For simplicity, the examples below include households with earned income as the only source of income. It is important to remember that reasonable compatibility is based on the individual's total countable income, not just his or her earned income amount.

Example 3: Joe is a single childless adult with an income limit of \$980.83 for BadgerCare Plus. He reports that his earnings are \$500/month. Equifax is not available for his employment. SWICA reports that his quarterly earnings are \$2,700, for a monthly amount of \$830.77. Because his income is below the income threshold using either amount, his reported information is considered to be reasonably compatible with the SWICA reported income, and the agency must use the \$500 amount he reported without requesting additional verification.

Example 4: Lon is a single childless adult with an income limit of \$980.83 for BadgerCare Plus. He reports that his earnings are \$900/month. Equifax reports that he is paid twice a month at \$510.50 per month, for a monthly amount of \$1021.00. Because there is a difference in the eligibility outcome when applying the Equifax reported income, his reported information is not considered to be reasonably compatible, and the agency must request additional verification.

Example 5: Melanie is a single childless adult with an income limit of \$980.83 for BadgerCare Plus. She reports that her earnings are \$1,200/month. CARES will base the denial on this reported income amount, regardless of the income amount from SWICA or Equifax.

Example 6: Michelle applies for BadgerCare Plus for herself and her two children. She reports that she started a job last month and is earning \$1,400/month. Because the job is new, neither SWICA nor Equifax data is available. Since these data

exchanges are not available, the reasonable compatibility test will not be performed, and Michelle will be required to verify her earnings using paystubs, an EVF-E form, or other documentation.

Example 7: Katie is a single childless adult with an income limit of \$980.83 for BadgerCare Plus. She applies for FS and BadgerCare Plus. She reports that her earnings are \$800/month. Equifax data is not available. SWICA reports that her quarterly earnings are \$2550, for a monthly amount of \$784.62. Because she is eligible for BadgerCare Plus using either amount, her reported information is considered to be reasonably compatible. The agency must use her reported income for BadgerCare Plus, and based on this amount, she would be made eligible for BadgerCare Plus.

Her FS eligibility, however, will pend for verification of her earnings. If she returns her paystubs and they show income of \$990/month, this information would replace the member-reported information and her health care benefits would be terminated. If she failed to provide the requested verification, her FS benefits would be denied but she would continue to remain eligible for BadgerCare Plus.

9.12.4 Determining a Data Exchange-Based Income Amount for the Reasonable Compatibility Test

The following rules will be used to determine the data exchange information that will be used for the reasonable compatibility test:

- If Equifax data is available for a given employment, CWW will apply a reasonable compatibility test for health care using the member-reported information and the data available from Equifax.
- If data from both Equifax and SWICA are available, only Equifax data will be used in the reasonable compatibility test.
- If Equifax data is not available, the system will use SWICA data if it is available as the basis of the reasonable compatibility test.

If SWICA data is used, CARES will divide the most recent quarterly SWICA wages by 13 and multiply by four (4) to determine a monthly amount for use in the test.

If Equifax data is used, the following rules will determine the monthly amount for use in the test:

- For months for which the system is able to confirm that all paycheck information has been received from Equifax, the actual income amount reported by Equifax for that month will be used.

- For months for which the system cannot confirm that all paycheck information has been received, the system will base the monthly amount on the most recent paycheck.
 - If the member is paid weekly, the most recent paycheck will be multiplied by four.
 - If the member is paid biweekly or semi-monthly, the most recent paycheck will be multiplied by two.
 - If the member is paid monthly, the most recent paycheck amount will be used.

9.12.5 Use of Equifax Data for Verification of Income

Agencies may not consider Equifax data to be the final “verified” income amount unless the Equifax data is the same as what the member reported. Agencies may not deny or terminate health care benefits based on earned income data received from Equifax without giving the applicant or member an opportunity to verify their reported earned income amount.

If the reported wage amount is the same as the Equifax wage amount, workers may consider the reported wage amount to be verified and use the verification code of “DE – Data Exchange”. If the worker is completing intake during a telephonic application for health care and/or an interview for FoodShare or Child Care, the worker should view the Equifax information during the interview and ask the member if the Equifax-reported amount is correct. If the member agrees that the Equifax-reported amount is accurate, the worker should use the Equifax-reported amount and a verification code of “DE – Data Exchange.” Because the wage has already been verified, the reasonable compatibility test will not be triggered for this employment.

If the worker is completing intake outside of an interview, and there is a discrepancy between what the member has reported and what Equifax provides, the worker must enter the member-reported information with a verification code of either ? or Q?. For health care programs, this will trigger a reasonable compatibility test. For other programs, this will cause the case to pend for verification of the member-reported amount.

If the member fails to provide verification and does not contact the agency, FoodShare, Child Care and/or W-2 will fail for lack of verification. Health care will fail for any member whose reported income is not reasonably compatible and who failed to provide requested verification.

However, if the member reports that he or she is unable to obtain the requested verification, the worker should assist the member in obtaining verification (see Chapter [9.8](#)). If the applicant and/or worker have made reasonable efforts to obtain verification and are not able to do so, then the agency should determine the income amount based on “best available” information, and then document how this amount was determined. .

Note: The same policies for use of Equifax data apply when a member is reporting a change in income. Equifax data can be used for verification if it is the same as what the member has reported. If it is not the same, health care will apply a reasonable compatibility test to determine whether further verification is required.

Example 8: Ryan applies online for himself, his wife, and their child, with a request for health care, Child Care and FoodShare. He reports earnings of \$9.55/hour at 30 hours/week from his job at Walmart on the application. The agency does not process the application until the interview for Child Care and FoodShare. During the interview, FDSH is queried for Equifax data and the worker sees that the most recent weekly paycheck amount was for an hourly rate of \$9.55/hour but for 33 hours/week, for a paycheck of \$315.15. The worker then confirms with Ryan that this amount is correct, enters this amount on the employment page and uses DE as the verification code. Because this information has been reported by the member and verified using Equifax data from the FDSH, it is considered verified for all programs and the reasonable compatibility test is not invoked.

Example 9: Mindy applies online for herself and her 2-year-old twins, with a request for health care, Child Care and FoodShare. She reports \$400/week in earnings from her job at Subway. When the worker processes the application for health care (prior to completing the interview for FoodShare and Child Care), the worker finds that Equifax data is available from the FDSH and that her most recent weekly paycheck is \$490. Because the member-reported and the FDSH-reported amount are different, the worker enters a Q? on the Employment page and runs eligibility. FoodShare and Child Care both pend for interview.

Because the employment amount has not yet been verified, a reasonable compatibility test is invoked for health care. For a group size of three (3), the reported household income is \$1600/month, or 97% FPL, while the household income based on FDSH data is \$1960/month, or 119% FPL.

- For Mindy's eligibility as a parent, the reasonable compatibility threshold is 100% FPL. The household's income based on reported income is below this threshold, while the household's income based on FDSH is above this threshold. As a result, the amounts are not reasonably compatible. Verification must be provided in order for Mindy to become eligible.
- For the twins, at age 2, the reasonable compatibility threshold is 191% FPL and no verification is needed. The household's income based on both the reported income and FDSH are below this threshold, so the reasonable compatibility standard is met and no further verification is required for the twins.

When the worker completes the Food Share / Child Care interview, the worker asks Mindy whether the information provided by Equifax is correct. Mindy confirms that it

is. The worker can then use the amount provided by Equifax on the employment page and changes the verification to DE. When eligibility is re-run for all programs, the employment is considered verified and no further verification is needed.

Example 10: Same as example 2, except that during the interview, Mindy tells the worker that her hours have changed and that her weekly pay is \$400 and not \$490. The worker should leave the Q? as the verification code for the employment and issue a verification checklist.

- If Mindy provides verification, the worker should use this to verify the income per current process.
- If Mindy fails to provide verification and does not contact the agency, the employment record will be marked as NV, and she will be denied for health care for lack of verification, although her children will continue to remain open because they were reasonably compatible. Both FoodShare and Child Care will fail due to failure to provide requested verification.
- If Mindy contacts the agency to say that she has not been able to obtain verification, the agency must assist with obtaining verification. If verification cannot be obtained, the worker should determine her income based on the “best available” information and document how this was determined in case comments.

*This page last updated in Release Number: 15-01
Release Date: 05/15/2015
Effective Date: 05/15/2015*

10 Child Welfare Parents

[View History](#)

10.1 CHILD WELFARE PARENT OR CARETAKER RELATIVE

Qualifying parents and *caretaker relatives* of children who have been temporarily removed from the home and are in the care of the child welfare system may be eligible for BadgerCare Plus benefits if they meet all the following requirements:

- Their child was living with them at the time the child welfare agency removed the child and placed him or her in:
 - Foster care (both IV-E and non IV-E).
 - Court-ordered Kinship Care.

- Another living arrangement.

Note: If child welfare is involved and the child welfare agency has established a permanency plan for the child under authority of Wis. Stat. § 48.38 or 938.38, other living arrangements for the children meet this criteria. For example, a child may be placed with grandparents who are not eligible for Kinship Care or a child may be placed with the other parent.

- The parent or caretaker relative is cooperating with a permanency plan, the goal of which is family reunification. Cooperation is always presumed unless the court has determined that reunification will no longer be the permanency goal.
- The caretaker relative meets all other BadgerCare Plus financial and non-financial requirements.

Note: Children are not considered to be in the care of the child welfare system if they are an inmate in a public institution, such as a Type 1 Juvenile Correctional Institution.

The parent or caretaker relative who meets the above requirements is considered caring for a child who has been temporarily removed from the home. The parent or caretaker relative did not have to be enrolled in BadgerCare Plus at the time of removal, but the child did have to live with the parent or caretaker. Even though the child's eligibility is not determined on the caretaker relative's case, the child is included in the group size in the eligibility determination, and any unearned income the child has is budgeted under *non-MAGI* rules.

If the child welfare system places a child with a Kinship Care relative, the Kinship Care relative may qualify for BadgerCare Plus as the caretaker relative of the child even if the *Child Welfare parent/caretaker* is also determined eligible as the caretaker relative of this child.

See [Process Help Chapter 14 Processing a Child Welfare Parents and Caretaker Relative \(CWPC\) Case](#) for information on processing the child welfare parent or caretaker relative cases.

The parent or caretaker relative who meets the above requirements is considered caring for a child who is temporarily absent. The parent or caretaker relative did not have to be enrolled in BadgerCare Plus at the time of removal, but the child did have to live with the parent or caretaker. The parent will continue to be considered a parent or caretaker for purposes of BadgerCare Plus eligibility under *MAGI* rules. However, the child may not always be included in the parent's *MAGI* group (see [Chapter 2 BadgerCare Plus Group](#) on the *MAGI* methodology).

If the child welfare system places a child with a Kinship Care relative, the Kinship Care relative is no longer considered a caretaker relative (if the parent is enrolled in

11.1 Out-of-Home Care (Foster Care)

BadgerCare Plus as a child welfare parent under the policy described above). Instead, the Kinship Care relative may qualify for BadgerCare Plus as a childless adult. If the parent is not enrolled as a child welfare parent, the Kinship Care relative may enroll in BadgerCare Plus as a caretaker relative.

Example 1: Stacy's child, Jared, was placed in Kinship Care with Stacy's mom Laura, who is 55 years old. Stacy files taxes but will not be claiming Jared as her tax dependent. Laura will claim Jared as her tax dependent. There are no other children, tax filers, or tax dependents in either Stacy's or Laura's households. If they both apply for BadgerCare Plus and meet all financial and non-financial requirements, Stacy will be eligible for BadgerCare Plus as a parent with a group size of one and Laura as a childless adult with a group size of two.

Example 2: Ben's daughter, Megan, was placed in Kinship Care with her grandfather James, who is 60 years old. Ben does not file taxes. James does file taxes and will claim Megan as his dependent that year. There are no other children, tax filers, or tax dependents in either Ben's or James's households. If they both apply for BadgerCare Plus and meet all financial and non-financial requirements, Ben will be eligible for BadgerCare Plus as a parent with a group size of two and James as a childless adult with a group size of two.

Example 3: Consider the details of Example 2, except James is now 66 years old. Under this example, James would not be eligible for BadgerCare Plus because he is a childless adult over 65 years old. He may, however, be eligible for *EBD* Medicaid.

Example 4: Christopher's son, Braden, was placed in Kinship Care with Christopher's sister, Vicki. Christopher is claiming Braden as a tax dependent but is not applying for BadgerCare Plus. If Vicki meets all financial and non-financial requirements, Vicki would be eligible for BadgerCare Plus as a caretaker relative with a group size of one.

*This page last updated in Release Number: 16-01
Release Date: 02/15/2016
Effective Date: 02/15/2016*

11 Foster Care Medicaid

[View History](#)

11.1 OUT-OF-HOME CARE (FOSTER CARE)

[11.1.1 Foster Care Medicaid Certification](#)
[11.1.2 Foster Care Medicaid Disenrollment](#)

Children or youth placed into any of the following placements are categorically eligible for Foster Care Medicaid:

- Foster Care (either IV-E or non-IV-E)
- Subsidized guardianship
- Court-ordered Kinship Care

Eligibility determinations for Foster Care Medicaid are not the responsibility of the *IM* agency. Child welfare agencies determine eligibility for Foster Care Medicaid when a child has been removed from the home and enters an out-of-home care placement, often referred to as Foster Care.

11.1.1 Foster Care Medicaid Certification

Eligibility for Foster Care Medicaid begins on the date the child or youth enters out-of-home care. Paper documentation is not required when certifying children placed in out-of-home care.

Foster Care Medicaid must be certified for no longer than 12 months. Children or youth certified for Foster Care Medicaid through *eWISACWIS* who remain in placement during the 12th month of eligibility will have their Foster Care Medicaid administratively renewed based on their placement. Children or youth certified for Foster Care Medicaid through other means should be certified for no longer than 12 months and re-certified if the child or youth is still eligible.

11.1.2 Foster Care Medicaid Disenrollment

When a child is discharged from out-of-home care, Foster Care Medicaid eligibility must be maintained until one of the following occurs:

- The child is determined eligible for another category of Medicaid or BadgerCare Plus.
- The child is determined ineligible for all categories of Medicaid and BadgerCare Plus.
- The child or family failed to provide the required information to complete an eligibility determination or chooses not to pursue other Medicaid benefits.
- The child dies or leaves Wisconsin.

When the child or youth is discharged from out-of-home care, the child welfare agency will extend Foster Care Medicaid eligibility under the Foster Care medical status code for an additional three months. During this time, IM agencies are expected to redetermine the child or youth's health care eligibility with assistance from the child welfare agencies, when needed. Child welfare agencies and IM agencies should set up a formal communication process to ensure IM agencies are made aware of all children

11.1 Out-of-Home Care (Foster Care)

leaving the Foster Care system, and provided with information necessary to redetermine eligibility.

To help facilitate communication between child welfare and IM agencies, *EM CAPO* will review a biweekly report of children or youth discharged from out-of-home care. EM CAPO will then research the child or youth's eligibility history in CARES.

If the child is returning to a household with an open health care benefit in CARES, EM CAPO will complete the Child or Youth Discharge from Out-of-Home Care Change Report (F-01665) and scan the form to the CARES case to alert workers of a household change.

If the IM agency does not have sufficient information to redetermine Medicaid eligibility, the agency must request needed information from the individual or family. Once the IM agency has enough information, it must determine eligibility for the youth or child as of the date the child returned to the home. If the youth or child is determined eligible, a Notice of Decision must be sent.

If the individual or family does not comply with a request for information after 30 days or if the youth or child is determined ineligible, a Notice of Decision must be sent denying BadgerCare Plus or Medicaid eligibility for the appropriate reasons. In addition, the IM agency must send a manual negative Notice of Decision specifically terminating eligibility for Foster Care Medicaid. The manual notice must be mailed at least 10 days before the Foster Care Medicaid end date. The end date can be found on the Child or Youth Discharge from Out-of-Home Care Change Report.

If the child is not returning to a household with an open health care benefit in CARES, EM CAPO will send the Important Information About Foster Care Medicaid letter (F-01661 or F-01661A) and a copy of the BadgerCare Plus Application (F-10182). The family or youth will need to apply for health care benefits. If no application is submitted, Foster Care Medicaid will end after the three-month extension period. The IM agency will not have to take any further action concerning health care benefits for the child or youth.

If an application is submitted before Foster Care Medicaid ends, the IM agency must process the application like any other health care application. If the agency is unable to make an eligibility decision prior to the end date of the Foster Care Medicaid, the IM agency needs to manually extend the Foster Care Medicaid eligibility an additional month and issue a manual positive Notice of Decision.

*This page last updated in Release Number: 16-01
Release Date: 02/15/2016
Effective Date: 11/23/2015*

[View History](#)

11.2 FORMER FOSTER CARE YOUTH

Until December 31, 2013, the age limit for the **FFCY** coverage group is 21 years old. Effective January 1, 2014, the age limit is 26 years old.

Youths who were in foster care, subsidized guardianships, or court-ordered Kinship Care on their 18th birthday qualify for a special status under BadgerCare Plus when they leave out-of-home care if all the following conditions are met:

1. The youth was receiving foster care (either IV-E or non-IV-E), subsidized guardianship, or court-ordered Kinship Care on the date that he or she turned 18 years old. It does not matter what state he or she was residing in when he or she turned 18 years old.
2. The youth is one of the following:
 - Younger than 21 years old prior to December 31, 2013
 - Younger than 26 years old on or after January 1, 2014
3. The youth meets the following BadgerCare Plus eligibility criteria:
 2. a. Is no longer receiving foster care benefits (which includes subsidized guardianships and court-ordered Kinship Care) but was receiving the benefits on his or her 18th birthday. Verification of the placement status on his or her 18th birthday is required.
 - b. Provides a **SSN** or cooperates in applying for one.
 - c. Is a U.S. citizen or national or is a qualifying immigrant.
 - d. Provides verification of U.S. citizenship and identity or qualifying immigration status or makes a good faith effort to obtain it.
 - e. Cooperates with child support enforcement agencies in obtaining medical support (if a parent).
 - f. Cooperates with **TPL** requirements.
 - g. Physically resides in Wisconsin and intends to reside in the state.
 - h. Is not an inmate.

There is no income or resource test for these youths while they are eligible under this status; therefore, they are not required to provide any income tax filing information in order for their BadgerCare Plus eligibility to be determined.

Note: If a FFCY is included in another household member's **AG**, his or her tax filing information may be needed to determine eligibility for those household members.

In addition, they are not subject to the BadgerCare Plus insurance access or coverage policies and are not required to pay any premiums for themselves. Regardless of income, they are eligible for the BadgerCare Plus Standard Plan unless they are found otherwise ineligible or until the end of the month in which one of the following occurs:

- They turn 21 years old (prior to December 31, 2013).
- They turn 26 years old (on or after January 1, 2014).

A 12 month recertification renewal is required to continue eligibility.

*This page last updated in Release Number: 14-03
Release Date: 09/05/14
Effective Date: 09/05/14*

12 Migrant Workers

[View History](#)

12.1 MIGRANT WORKERS

When determining a migrant family's eligibility for BadgerCare Plus use the appropriate rules as outlined in [Chapter 2](#), depending on whether budgeting using *non-MAGI* rules or *MAGI* rules.

*this page last updated in Release Number: 13-02
Release Date: 10/25/13
Effective Date: 10/01/13*

[View History](#)

12.2 Migrant Worker Definition

A "Migrant worker" is a person who:

1. Temporarily leaves his or her principal place of residence (outside of Wisconsin) and
2. Comes to Wisconsin for not more than ten months per year in order to accept seasonal employment in the planting, cultivating, raising, harvesting, handling, drying, packing, packaging, processing, freezing, grading or storing of any agricultural or horticultural commodity in its unmanufactured state.

"Migrant worker" does not include the following:

1. A person who is employed only by a state resident if the resident or the resident's spouse is related to the person as the child, parent, grandchild, grandparent, brother, sister, aunt, uncle, niece, nephew, or the spouse of any such relative.
2. A student who is enrolled in or, during the past six months has been enrolled, in any school, college or university unless the student is a member of a family or household which contains a migrant worker.

*This page last updated in Release Number: 07-01
Release Date: 10/29/07
Effective Date: 02/01/08*

[View History](#)

12.3 Simplified Application

Migrant workers and their families can have their eligibility for BadgerCare Plus determined using a simplified *application* process if they:

1. Have current Medicaid eligibility from another state. ("Current Medicaid eligibility" means eligibility that includes at least months one and two of the application process.) Or had Medicaid/BadgerCare Plus eligibility in Wisconsin that was certified through months one and two of the application and that ended only because the family left Wisconsin.
2. And have the same members or fewer in the case as there were when the case had coverage in the other state.

The simplified application procedure is as follows:

1. For applicants with current Medicaid eligibility from another state, verify the eligibility and the end date. Verify with a copy of the out-of-state Medicaid card or by contacting the other state.
2. For applicants previously eligible in Wisconsin, determine the closure code and renewal date.
3. Determine if the same members, or fewer, are in the case compared to when the group was eligible in the other state.
4. Collect all non-financial information.
5. Do not collect any financial information.

6. Certify BadgerCare Plus benefits for the migrant family.

Example 1: A migrant family consisting of Dad, Mom, and their three children come to Wisconsin. On July 3, Dad applies for BadgerCare Plus in Wisconsin for his family.

The family has current Medicaid eligibility from Texas with a [certification period](#) ending on November 30. That is, eligibility extends beyond application months one and two.

The household has the same five members listed on the Medicaid card.

Because the two conditions described in [12.2](#) are met, the case should be processed using the simplified application procedure.

Example 2: The same migrant family comes in for the November review. Verify all mandatory and questionable verification items. The family is determined eligible through October 31 of the following year.

The family leaves Wisconsin in December. BadgerCare Plus closes for failure to reside in the state. The next March, the family returns. There have been no non-financial changes and no changes in household composition. The family should be processed with the simplified application procedure because their case closed only for failure to reside in Wisconsin.

12.3.1 Renewal dates for simplified application

For migrant families that have been certified through the migrant simplified application process, the first renewal coincides with the date out-of-state eligibility ends. The next renewal is 12 months from the first renewal

See example 1 above. The renewal date should be set for November since that is the last month of the certification period for the Texas Medicaid.

*This page last updated in Release Number: 13-02
Release Date: 10/24/13
Effective Date: 10/01/13*

[View History](#)

12.4 REGULAR APPLICATION

If migrant workers and their families have no current BadgerCare Plus/Medicaid eligibility in Wisconsin or another state, or if there are additional family members who were not eligible in the prior state of residence, process the case as a regular BadgerCare Plus *application*, with the following exception:

Use annualized earned income. "Annualized earned income" is a prospective monthly estimate of earned income based on the estimated total gross annual earnings divided by 12. Annualized income can be based on the past 12 months of the migrant family's income if it is anticipated that last year's income is the best estimate of the current year's prospective income.

Renewal dates for regular applications

For migrant families that have been certified through the regular application process, the first renewal is 12 months from the month of application.

12.4.1 Renewals

Offer the following three renewal choices for migrant families:

1. Mail.
2. Phone.
3. Face-to-face interview.

See [Chapter 26](#) for information on renewals.

*This page last updated in Release Number: 13-02
Release Date: 10/25/13
Effective Date: 10/01/13*

13 - 15 Reserved

[View History](#)

CHAPTERS 13-15 (RESERVED)

*This page last updated in Release Number: 07-01
Release Date: 10/29/07
Effective Date : 02/01/08*

FINANCIAL REQUIREMENTS (CHAPTERS 16-24)

16 Income

[View History](#)

16.1 INCOME

16.1.1 Income Limits

Population	Income Limit for Existing members through March 31, 2014	Income Limit for New Applications as of February 1, 2014	Income Limits for all Members effective April 1, 2014
Pregnant Women	300% FPL* (<i>non-MAGI</i> rules)	306% FPL (<i>MAGI</i> rules)	300% FPL (<i>non-MAGI</i> rules) 306% FPL (<i>MAGI</i> rules)
Children under 19*	No Limit	No Limit	300% FPL (<i>non-MAGI</i> rules) 306% FPL (<i>MAGI</i> rules)
Parents/Caretaker Relatives	200% FPL	100% FPL	100% FPL
Childless Adults	200% FPL	N/A	100% FPL
Family Planning Only Services	300% FPL (<i>non-MAGI</i> rules)	306% FPL (<i>MAGI</i> rules)	300% FPL (<i>non-MAGI</i> rules) 306% FPL (<i>MAGI</i> rules)

*Children and pregnant women with income above the limit can become eligible by meeting a deductible.

See [Chapter 50.1](#) for the most recent Federal Poverty Level limits.

The income limits under MAGI rules listed above include the following income disregards.

- Children, pregnant women and individuals eligible under Family Planning Only Services will be allowed an income disregard equal to 5% of the FPL in addition to a conversion factor adjustment equal to 1% of the FPL. While the

income limit remains 300% FPL, CWW will actually test against an income limit of 306% FPL once the income disregard and conversion factor are included.

- Parents, caretakers and childless adults already have the income disregard included in the income limit of 100% FPL. CWW will test against an income limit of 100% FPL.

Note: Other effective income limits for children under *MAGI* rules will also reflect the addition of the 6% disregard with the exception that the income thresholds for children's premiums will only be increased by 1%.

16.1.2 Income Under Non-MAGI Rules

In general, all available gross income is counted when determining BadgerCare Plus eligibility under non-MAGI rules for existing BadgerCare Plus members with a filing date prior to February 1, 2014. See unavailable income below for exceptions to this rule.

Gross income is the total income before any amounts are subtracted or withheld (i.e. taxes, garnishments, repayment amounts, etc.)

Net income is the amount of income after deductions are withheld.

Available income. Income is available when:

1. It is actually available, and
2. The person has a legal interest in it, and
3. The person has the legal ability to make it available for support and maintenance.

An example of an income source that someone can make available is unemployment compensation.

When it is known that a member of the group is eligible for income or an increased amount of income:

1. If the amount is known, count the income as if the person is receiving it. If the amount is unknown, ignore the income.

Example 1: Ms. M. is entitled to Worker's compensation benefits of \$430. However, she declined a \$100 increase offered by the insurance company, and the amount of her check remains at \$430. Since the full entitlement amount is known, the available income is \$530.

Unavailable Income: Income is unavailable when it will not be available for 31 days or more. The person must document that it will not be available for 31 days or more.

Unavailability is documented by a letter from the source of the income stating when the person will receive the benefit. Thus, if he or she has just applied for benefits, the income would not be counted. The income is not ignored; it is just not counted until it becomes available. Schedule an eligibility review for no later than the 60th day.

All taxable income is counted when determining BadgerCare Plus eligibility under *MAGI* rules. Social Security income is also counted under MAGI rules. See [16.2](#) for the list of income that is not counted. These rules apply to families that are filing taxes and those who are not.

16.1.3 Income Under MAGI Rules

All taxable income is counted when determining BadgerCare Plus eligibility under MAGI rules. Social Security income is also counted under MAGI rules. See [16.2](#) for the list of income that is not counted. These rules apply to families that are filing taxes and those who are not.

Within a MAGI group, income will be counted as detailed in [Chapter 2](#). For any member whose income is budgeted for their assistance group, income under the countable income types listed in [16.4](#) and [16.5](#) will be counted and deductions under the types listed in [16.3](#) will be allowed. See Chapter 2 for determining the assistance group size.

All MAGI group members' income is counted with one exception: If a group member is the child or tax dependent of another group member, his or her income is only counted if he or she is "expected to be required" to file a tax return for the current year. See section [2.8.2](#) for more information.

If a member's income is budgeted for his or her assistance group, his or her deductions will be counted for that group. In situations where an individual is planning to file a joint tax return with his or her spouse, the individual's deductions may offset the spouse's income even if the individual has no income.

Note: The availability of income does not affect whether or not the income is counted under MAGI rules.

When it is known that a member of the group is eligible for income or an increased amount of income:

1. If the amount is known, count the income as if the person is receiving it.
2. If the amount is unknown, ignore the income.

Example 2: Ms. M. is entitled to Unemployment compensation benefits of \$430. However, she declined a \$100 increase offered by unemployment compensation, and the amount of her check remains at \$430. Since the full entitlement amount is known, the available income is \$530.

16.1.4 Gap Filling

Due to differences between the eligibility rules used by the Marketplace for Advanced Premium Tax Credits (APTC) and the eligibility rules used when counting income for BadgerCare Plus, the Marketplace may find someone to be below 100% FPL based on their annual income, while BadgerCare Plus may find someone to be above 100% FPL based on their current monthly income. Because of this difference in eligibility rules, the individual is eligible for neither BadgerCare Plus nor APTCs. If applicants were left in this eligibility “gap”, then only option available is to pay for the full cost of private health insurance through the Marketplace. To prevent this from happening, we must enroll these individuals based on a monthly equivalent of their expected annual income under a process called “gap filling”.

16.1.4.1 Processing Application for Individuals Eligible Under Gap Filling Rules

Local agencies should contact the DHS CARES Call Center when an individual has applied at the Marketplace and has received a notice indicating that they can purchase health insurance but cannot get an APTC, and has also been denied BadgerCare Plus because of monthly income above 100% FPL.

The CARES Call Center will confirm whether the individual meets the criteria for gap filling certification. If so, the CARES Call Center will add a case comment to CWW. EM CAPO will then manually certify the member, track his or her individual enrollment outside of CWW, and serve as the point of contact for that member’s eligibility under gap filling rules. The EM CAPO will send a notice of decision informing the individual of his or her eligibility and change reporting rules. Changes for that individual will be reported to and processed by the EM CAPO while he or she is eligible under gap filling rules.

The case itself will remain with the consortium, which will manage eligibility for other programs or individuals who may be open as part of that case.

16.1.4.2 Processing Renewals for Individuals Eligible Under Gap Filling Rules

Because the Marketplace considers annual income on a calendar-year basis, the manual gap-filling certification will last until the end of the calendar year. Approximately 45 days prior to the end of the year, members will receive a notice from EM CAPO advising them that their eligibility is ending and directing them to return to the Marketplace (or, if appropriate, reapply for BadgerCare Plus). A gap-filling member can also lose eligibility during the certification period if:

- He or she moves out of state; or,
- He or she has expected annual income of more than 100% FPL.

16.1.4.3 Eligible Under Another Category of BadgerCare Plus or Medicaid

EM CAPO will end the gap-filling certification if the member has become eligible in another category of BadgerCare Plus or Medicaid.

*This page last updated in Release Number: 15-01
Release Date: 05/15/2015
Effective Date: 05/15/2015*

[View History](#)

16.2 Income Types Not Counted

1. [Adoption Assistance](#)
2. [Agent Orange Settlement Fund](#)
3. [Combat Pay](#)
4. [Other Military Pay](#)
5. [Crime Victim Restitution Program](#)
6. [Disaster and Emergency Assistance](#)
7. [Earned Income](#) (non-MAGI only)
8. [Foster Care](#)
9. [Individual Development Account](#)
10. [Jury Duty Payments](#) (non-MAGI only)
11. [Kinship Care](#)
12. [Life insurance policy dividends](#)
13. [Nutrition Benefits](#)
14. [Payments to Native Americans](#)
15. [Payments to Nazi Victims](#)
16. [Radiation Exposure Compensation Act \(PL 101-426\)](#)
17. [Refugee Cash Assistance](#)
18. [Refugee "Reception and Placement"](#)
19. [Reimbursements](#)
20. [Relocation Payments](#)
21. [Repayments](#)
22. [Special Programs](#)
23. [Spinal Bifida Child](#)
24. [Susan Walker Payments](#)
25. [Student Financial Aids](#)
26. [Stipends from the University of Wisconsin Upward Bound Program](#)
27. [Tax Refunds \(Income and EITC\)](#)
28. [Unpredictable Income](#)
29. [Veterans Benefits](#)
30. [Wartime Relocation of Citizens](#)
31. [Workforce Investment Act Unearned Income](#)
32. [W-2 Payments](#)
33. [General Relief and Charity](#)

34. [SSI](#)
35. [Interest and Dividend income](#) (*non-MAGI only*)
36. [Lump Sum Payments](#) (*non-MAGI only*)
37. [Property Settlements](#)
38. [Subsidized Guardianship](#)
39. [The American Recovery and Reinvestment Act of 2009](#)
 40. [Child Support](#)
 41. [Gifts](#)
42. [Money from another person](#)
43. [Inheritances, Bequests, and Devises](#)
44. [Workers' Compensation](#)

The following types of income are not included in the countable income when determining eligibility for BadgerCare Plus.

1. **Adoption Assistance.**
2. **Agent Orange Settlement Fund.** Do not count payments received from the Agent Orange Settlement Fund or any other fund established in settling In Re "Agent Orange" Product Liability Litigation, M.D.L. No. 381 (E.D.N.Y.). This is retroactive to January 1, 1989. Do not count these payments for as long as they are identified separately.
3. **Combat Pay.** Do not count combat zone pay that goes to the household that is in excess of the military person's pre-deployment pay. The exclusion lasts while the military person is deployed to the combat area.

If the amount of military pay from the deployed absent family member is equal to or less than the amount the household was receiving prior to deployment, count all of the income to the household. Any portion of the military pay that exceeds the amount the household was receiving prior to deployment to a designated combat zone should not be counted when determining the household's income.

Example 1: John's wife Bonnie and their daughter have an open BadgerCare Plus case. John is in the military stationed overseas; his monthly income is \$1,000. John sends his wife \$1,000 every month.

When John is deployed to a combat zone his pay is increased to \$1,300 a month, which is deposited into a joint account. Because the \$300 is combat zone pay, it is not counted in the determination. The pre-combat pay of \$1,000 is budgeted as unearned income for BadgerCare Plus.

4. **Other Military Pay.** Do not count income received for the following purposes:

- Living allowances
 - Basic Allowance for Housing
 - Basic Allowance for Subsistence
 - Housing and cost-of-living allowances abroad paid by the U.S. government or by a foreign government
 - Overseas Housing Allowance
- Death allowances
- Family allowances
- Moving allowances
- Travel allowances
- Professional education allowances
- ROTC educational and subsistence closure benefit allowances
- Uniform allowances

Note: Military pay can be verified using the Leave and Earnings Statement received by active duty personnel.

5. **Crime Victim Restitution Program** payments received from a state-established fund to aid victims of a crime.

6. **Disaster and Emergency Assistance** payments made by federal, state, county, and local agencies and other disaster assistance organizations.

7. **Earned Income** of individuals younger than 18 years old.

For cases under *non-MAGI* rules, disregard the income until the month following the month in which the person turns 18 years old.

For cases under *MAGI* rules, see [Section 2.8.2 MAGI Income Counting Rules](#) for information about counting income.

8. **Foster Care.**

9. **Individual Development Account** payments that are made in the form of matching funds to buy a home, start a business, or to complete post-secondary education.

10. **Jury Duty Payments.** Count any portion of a jury payment that is over and above expenses as earned income for the month in which it is received.

For cases under *non-MAGI* rules, count any portion of a jury payment that is over and above expenses as earned income for the month in which it is received.

For cases under *MAGI* rules, count all jury duty payments as earned income for the month in which it is received if the payments are not turned over to the individual's employer. Amounts received separately as reimbursements or allowances for travel to and from the courthouse, meals, and lodging during jury duty are not countable.

11. Kinship Care.

12. Life Insurance policy dividends.

13. Nutrition Benefits received from the following:

- a. Emergency Food and Shelter National Board.
- b. Federal Emergency Management Assistance.
- c. FoodShare allotment.
- d. Home produce for household consumption.
- e. National School Lunch Act.
- f. Supplemental food assistance under the Child Nutrition Act of 1966.
- g. Title VII, Nutrition Program for the Elderly, of the Older Americans Act of 1965.
- h. *USDA* Child Care Food Program.
- i. *USDA*-donated food and other emergency food.
- j. *WIC*—the supplemental food program for women, infants, and children.

14. Payments to Native Americans from:

- a. Distributions from Alaska Native Corporations and Settlement Trusts, including:
 - Menominee Indian Bond interest payments.
 - All judgment payments to tribes through the Indian Claims Commission or Court of Claims.
 - Payments under the Alaskan Native Claims Settlement Act.
 - Payments under the Maine Indian Claims Settlement Fund.
 - Payments under PL 93-124 to the Sisseton-Wahpeton Sioux Tribe, except under non-MAGI rules, individual shares over \$2,000.
 - Payments under PL 93-134 to the Maricopa Ak-Chin Indian Community, Navajo Tribe, Coast Indian Community of the Resighini Rancheria, Stillaguamish Tribe, Pueblo of Taos Tribe, Walker River Paiute Tribe, and White Earth Band of the Minnesota Chippewa Tribe, except under non-MAGI rules, individual shares over \$2,000.
 - Payments under PL 94-114 to the Bad River Band and Lac Courte Oreilles Band of Chippewa Indians and the Stockbridge Munsee Indian Community of Mohicans.

- Payments under PL 96-318 to the Delaware Tribe of Kansas and of Idaho.
- Payments under PL 96-420 to the Houlton Band of Muliseet Indians, the Passamoquoddy, and Penobscot.
- For *EBD* Medicaid cases, under PL 98-64, disregard all Indian judgment funds held in trust by the Secretary of the Interior for an Indian tribe and distributed on an individual basis to members of the tribe. Also disregard interest and investment income from these funds.
- Payments under PL 99-346, Saginaw Chippewa Indian Tribe of Michigan.
- Payments under PL 99-377 to the Mille Lacs, Leech Lake, and White Earth, Minnesota reservations.
- Payments under PL 101-41, Puyallup Tribe of Indians Settlement Act of 1989.
- Payments under the Distribution of Judgment Funds Act of 1987 to the Cow Creek Band, Umpqua Tribe.
- Payments under the Distribution of Indian Judgment to the Crow Creek and Lower Brule Sioux except individual shares over \$2,000.
 - Payments under the settlement of the *Cobell v. Salazar* class-action trust case.

b. Other Exempt Tribal Payments

Disregard non-gaming tribal income from the following sources:

- Distributions and payments from rents, leases, rights of way, royalties, usage rights, or natural resource extraction and harvest from:
 - Rights of ownership or possession in any lands held in trust, subject to federal restrictions, located within the most recent boundaries of a prior federal reservation, or otherwise under the supervision of the Secretary of the Interior; or
 - Federally-protected rights regarding off-reservation hunting, fishing, gathering, or usage of natural resources
- Distributions resulting from real property ownership interests related to natural resources and improvements:
 - Located on or near a reservation or within the most recent boundaries of a prior federal reservation; or
 - Resulting from the exercise of federally-protected rights relating to such real property ownership interests

c. Payments to tribal members from gaming revenue:

- Under non-MAGI rules, disregard the first \$500 of the monthly income from Tribal Per Capita payments from gaming revenue. If the payments are received less than monthly, prorate the gross payment amount over the months it is intended to cover and disregard \$500 from the monthly amount.
- Under MAGI rules, all of the income from Tribal Per Capita payments from gaming revenue are counted income.

15. **Payments to Nazi Victims** made under PL 103-286 to victims of Nazi persecution.
16. **Radiation Exposure Compensation Act (PL 101-426)** payments to persons to compensate injury or death due to exposure to radiation from nuclear testing (\$50,000) and uranium mining (\$100,000). The federal Department of Justice reviews the claims and makes the payments. If the affected person is dead, payments are made to his or her surviving spouse, children, parents, or grandparents. This is retroactive to October 15, 1990. Do not count these payments for as long as they are identified separately.
17. **Refugee Cash Assistance** program payments. The Refugee Cash Assistance program is administered by *W-2* agencies and is made available for refugees who do not qualify for W-2.
18. **Refugee "Reception and Placement"** payments made to refugees during the first 30 days after their arrival in the U.S. Reception and Placement payments are made by voluntary resettlement agencies and may be a direct payment to the refugee individual/family or to a vendor.
19. **Reimbursements** for out-of-pocket expenses that an assistance group member has incurred and/or paid. However, reimbursements for normal household living expenses (rent, clothing, or food eaten at home) are counted.

Examples of reimbursements that are not counted:

- a. For job- or training-related expenses. The expenses may be for travel, food, uniforms, and transportation to and from the job or training site. This includes travel expenses of migrant workers.
- b. For volunteers' out-of-pocket expenses incurred during their work.
- c. Medical or dependent care reimbursements.
- d. Reimbursement from the Indianhead Community Action Agency (Ladysmith) under its JUMP Start Program for start-up costs to set up an in-home child care business in the person's home.
- e. Reimbursements received from the Social Services Block Grant Program for expenses in purchasing Social Services Block Grant services (for example, transportation, chore services, and child care services).

The reimbursement payment should not be more than the person's actual out-of-pocket expenses. If it is more, count the excess amount as unearned income.

20. Relocation Payments. Under Wis. Stat. § 32.19, relocation payments are available to displaced persons. The following are examples of costs that the relocation payments are intended to cover: moving expenses and replacement housing and property transfer expenses. Do not count the amounts paid by any governmental agency or organization listed in Wis. Stat. § 32.02. Do not count Title II, Uniform Relocation Assistance and Real Property Acquisition Policies Act payments. Its purpose is to treat people displaced by federal and federally aided programs fairly so that they do not suffer disproportionate injuries as a result of programs designed for the public's benefit.

Do not count Experimental Housing Allowance Program payments. Its purpose is to study housing supply. Test areas, which include Brown County, were selected throughout the United States, and contracts were entered into prior to January 1, 1975. A sample of families was selected to receive monthly housing allowance payments.

21. Repayments of money the member has received from an economic support program and must give back because of a program error or violation. Since he or she is not entitled to the money, he or she must repay it; therefore it should not be counted as income to the member.

Do not count the following repayments:

- Money withheld from an economic assistance check due to a prior overpayment.
- Money from a particular income source that is voluntarily or involuntarily paid to repay a prior overpayment received from that same source of income.

If money from a particular income source is mixed with money from other types of income, disregard only an amount up to the amount of the current payment from the particular source.

Example 2: Richard receives \$50 a month from the VA and \$250 from Social Security. The income from the two sources is added together to equal \$300. If the VA overpays Richard by \$200, he can only pay back the \$50 a month he receives from the VA. If he repays more, for instance, \$75 a month, only \$50 should be disregarded.

- Social Security income used to repay an overpayment previously received from the Social Security Administration, whether SSA or **SSI**.

22. Special Programs income received from any of the following:

- Active Corp. of Executives.
- Wages paid by the Census Bureau for temporary employment related to Census 2010.
- Emergency Fuel Assistance.
- Foster Grandparents Program.
- Governmental rent or housing subsidy, including reimbursements due to federal regulatory changes in computing HUD housing rent.
- Homestead Tax Credit.
- Low Income Energy Assistance Program.
- Programs funded under Title V of the Older Americans Act of 1965 (see [Section 16.4.1 #5](#)), except wages or salaries, which are counted as earned income.
- Retired Senior Volunteer Program.
- Service Corp. of Retired Executives.
- University Year for Action Program.
- Under non-MAGI rules, income from Volunteers in Service to America is not counted. Under MAGI rules, earnings and cash benefits from Volunteers in Service to America are counted.
- Wisconsin's Family Support Program (Wis. Stat. § 46.985). This program funds the unique needs of severely disabled children. They may be a vendor or a money payment.

23. Spinal Bifida Child (PL 104-204) payments to any child of a Vietnam veteran for any disability resulting from the child's spinal bifida.

24. Susan Walker Payments received from the class action settlement of Susan Walker vs. Bayer Corporation. These payments are to hemophiliacs who contracted the HIV virus from contaminated blood products.

25. Student Financial Aids.

Under non-MAGI rules, student financial aids are not counted as income regardless of source. This includes student loans, grants, scholarships and work study, and any financial assistance provided by a public or private organization for the purpose of obtaining an education. Disregard the full amount of student financial aids, including any amounts earmarked for living expenses. Count income from an internship or assistantship that is not part of work study or another student aid as earned income.

<p>Example 3: Clark is a journalism student. The University School of Journalism has</p>

arranged an internship for him to work 10 hours a week at The Daily Planet. The newspaper pays him \$30 a week. This income is counted as earned income when determining Clark's eligibility.

Under MAGI rules, work study income and any income from an internship or assistantship should be counted as earned income. Grants, scholarships, fellowships, and any additional financial assistance provided by public or private organizations that exceed the cost of tuition, books, and mandatory fees are counted as unearned income and should be prorated over the period of time they are intended to cover. Student loans are not counted as income regardless of what the loan is used to pay for.

Example 4: Mary was awarded a scholarship for \$3,500 in July that is intended to cover her fall semester (September through December). Her tuition and course related expenses are \$3,250 for the semester. The \$250 that exceeds the amount of tuition and course-related expenses will be prorated over the four-month period from September through December at \$62.50 in unearned income each month ($\$250/4 \text{ months} = \$62.50/\text{month}$).

The following types of grants, scholarships, and fellowships are counted as income:

- Pell Grants
- Robert Byrd Honors scholarships
- Any grants, scholarships, or fellowships received from the college or university as part of a financial aid package
- Any grants, scholarships, or fellowships provided by public or private organizations

The following educational aid types are not counted as income:

- Loans, including Stafford Loans and Perkins Loans
- AmeriCorps or HealthCorps grant
- Bureau of Indian Affairs grant
- GI Bill/Veterans benefits
- ROTC benefits

Note: These income types will not be considered when determining if grants, scholarships, and fellowships exceed the cost of tuition, books and mandatory fees.

The following expense types will be used to offset income from grants, scholarships, fellowships, and other financial aid:

- Tuition
- Required books, supplies, or equipment
- Mandatory fees

The following expense types will not be allowed to offset income from grants, scholarships, or other financial aid:

- Room
- Board (meals or meal plans)
- Personal expenses
- Transportation and parking
- Loan fees
- Health insurance costs

26. Stipends from the University of Wisconsin Upward Bound Program paid to high school students to encourage low income students to further their education.

27. Tax Refunds (Income and *EITC*).

28. Unpredictable Income, which is unpredictable, irregular, and has no appreciable effect on ongoing need.

29. Veterans Benefits.

Under non-MAGI rules, count veterans benefits as unearned income. Do not count VA allowances for unusual medical expenses that are received by a veteran, their surviving spouse, or dependent. Do not count aid and attendance and housebound allowances received by veterans, spouses of disabled veterans, and surviving spouses. For institutionalized and community waiver cases, do not count these allowances in eligibility and post-eligibility determinations, except for residents of the State Veterans Home at King.

Under MAGI rules, do not count any veterans' benefits paid under any law, regulation, or administrative practice administered by the VA. The following amounts paid to veterans or their families are not countable:

- Education, training, and subsistence allowances. (i.e., GI Bill benefits)
 - Disability compensation and pension payments for disabilities paid either to veterans or their families.
 - Grants for homes designed for wheelchair living.
 - Grants for motor vehicles for veterans who lost their sight or the use of their limbs.
 - Veterans' insurance proceeds and dividends paid either to veterans or their beneficiaries, including the proceeds of a veteran's endowment policy paid before death.
 - Interest on insurance dividends left on deposit with the VA.
 - Benefits under a dependent care assistance program.
 - The death gratuity paid to a survivor of a member of the Armed Forces who died after September 10, 2001.
 - Payments made under the compensated work therapy program.
 - Any bonus payment by a state or political subdivision because of service in a combat zone.

Do not count VA allowances for unusual medical expenses that are received by a veteran, their surviving spouse, or dependent. Do not count aid and attendance and housebound allowances received by veterans, spouses of disabled veterans, and surviving spouses. For institutionalized and community waiver cases, do not count these allowances in eligibility and post-eligibility determinations, except for residents of the State Veterans Home at King.

30. Wartime Relocation of Citizens (PL 100-383) restitution payments made to individual Japanese-Americans (or their survivors) and Aleuts who were interned or relocated during World War II.

31. Workforce Investment Act Unearned Income paid to any adult or minor participating in the Workforce Investment Act, including:

- a. "Need-based payments" paid to persons as allowances to enable them to participate in a training program.
- b. "Compensation in lieu of wages" paid to persons in "tryout employment." This is arranged when private for-profit opportunities are not available and is generally limited to persons younger than 22 years old. Ask any applicant younger than 23 years old, or the local Workforce Investment Act staff if he or she is participating in "tryout employment." If he or she is, count this as unearned income.
- c. "Payments for supportive services" paid to persons in training programs who are not able to pay for training-related expenses (e.g., transportation, health care, child care, meals).

32. W-2 Payments for W-2 Transition, *Custodial Parent* of an Infant, At Risk Pregnancy, and Community Service Jobs. Do not disregard payments for Trial Employment Match Program or Transform Milwaukee Jobs.

33. General Relief and Charity.

34. SSI.

SSI is not counted income for BadgerCare Plus. The following is a brief list of the potential codes for SSI.

- SI - SSI/Supplemental Security Income
- SISE - SSI-E/Supplemental Security Income - Expenditure
- SISS - State Supplemental Security Income

35. Interest and Dividend Income.

Under *non-MAGI* rules, interest and dividend income is not counted income for BadgerCare Plus.

Under *MAGI* rules, interest and dividend income is counted as unearned income.

36. Lump Sums Payments.

Under *non-MAGI* rules, lump sum payments (rather than recurring payments) from such sources as insurance policies, inheritance, sale of property, Railroad Retirement, Unemployment Compensation benefits, and retroactive corrective financial aid payments are counted as an asset when received. There is no asset test for BadgerCare Plus (see [Section 20.1 Assets](#)). The payment can be either unearned or earned income. However, do not include payments that are included in farm or self-employment income.

Under *MAGI* rules, count lump sum payments (if the payment is otherwise a countable income type) in the month received.

37. Property Settlement.

Money received as a property settlement is always an asset, regardless of whether it is paid in one payment or installments. It is never income.

38. Subsidized Guardianship Payments.

Subsidized guardianship payments are not counted for BadgerCare Plus.

39. The American Recovery and Reinvestment Act of 2009.

Disregard the one time payments of \$250 sent to SSI, veterans, Railroad Retirement, and Social Security recipients as a result of the American Recovery and Reinvestment Act of 2009.

Effective February 1, 2009, disregard the \$25 per week temporary supplement benefits from Unemployment Compensation.

40. Child Support.

Under *non-MAGI* rules, count child support income as unearned income.

Under *MAGI* rules, do not count child support income. If a household is receiving family support, divide the payment by the number of members in the household. The amount of the payment allocated to the child(ren) is considered child support and is disregarded. Count the amount of the payment allocated to the adult(s) as alimony/spousal support unless the divorce/separation order by the court designates the spousal support payments as being non-taxable. If the spousal support payments are non-taxable, they are exempt under *MAGI* rules (see

[Process Help 62.2.6 Entering Child Support Income on an Unearned Income Page](#)).

Example 5: Morgan receives \$500/month in family support for herself and her three children, Kyra (age 15), Kevin (age 9), and Katie (age 7). $\$500/4 \text{ people} = \$125/\text{person}$. Disregard the amount allocated to the children ($\$125 \times 3 \text{ children} = \375). Count \$125/month as income for Morgan.

41. Gifts.

A gift is something a person receives, is not repayment for goods or services the person provided, and is not given because of a legal obligation on the giver's part. To be a gift, something must be given irrevocably (that is, the donor relinquishes all control).

Under *non-MAGI* rules, count monetary gifts over \$30 a calendar quarter. A calendar quarter is three consecutive months beginning with January, April, July, or October.

Under *MAGI* rules, do not count the value of a gift as income.

Example 6: Marco's grandmother gave him \$1,600 to help pay for his classes at a local technical college. Marco's eligibility is determined using MAGI rules. Do not count this \$1,600 as income.

42. Money from another person is money a person receives that is not repayment for goods or services the person provided and is not given because of a legal obligation on the giver's part. Money from another person is not a loan.

Under *non-MAGI* rules, count money from another person if the amount is over \$30 a calendar quarter. A calendar quarter is three consecutive months beginning with January, April, July, or October.

Under *MAGI* rules, do not count money from another person as income (see [43](#) for policies regarding money received from another person through an inheritance, bequest, or devise).

Example 7: Mimi receives \$500 each month from her parents. She is not expected to pay back this money. Mimi's BadgerCare Plus eligibility is determined using MAGI rules. The \$500 is not counted as income for BadgerCare Plus eligibility.

Note: If money received from another person is in exchange for goods or services (such as an informal arrangement in which someone rents a room in his or her house) and if the payment is regular and predictable, it should be counted under both MAGI and non-MAGI rules. See [Section 16.4.3.1 Income Sources](#) for information on counting rental income.

Example 8: Jeremy pays Micah \$300 each month to live in a room in Micah's house. Micah and Jeremy do not have a formal lease agreement, but the payment is regular and predictable. Count the \$300/month as income for BadgerCare Plus eligibility.

43. Inheritances, Bequests, and Devises.

An inheritance is property received from someone who is deceased without a valid will. A bequest is personal property received from someone who is deceased, as directed by that decedent's will. A devise is real property received from someone who is deceased, as directed by that decedent's will.

Inheritances, bequests, and devises are generally not taxable, and, as a result, the value of the inheritance, bequest, or devise is generally not counted as income under MAGI rules.

However, there are a few forms of inheritances or bequests that may be taxable. For example, distributions from an inherited pension are usually taxable to the beneficiary if the distributions would have been taxable if the deceased were still living.

In addition, income generated from an inheritance, bequest, or devise is usually taxable.

For inheritances, bequests, and devises that are taxable, the income should be counted only in the month it was received if it was received as a lump sum. If the payments are regular and predictable, they should be prorated (unless they are received monthly) and counted accordingly.

Example 9: Roger's aunt passed away, and Roger inherited her rental house. It is worth \$100,000. The house is occupied by tenants who pay \$800/month in rent. At the time of the deed transfer, the tenants owed \$3,200 in back rent. The value of the \$100,000 property is not taxable, but if the tenants pay Roger the \$3,200 in back rent, that income is taxable and would be counted under MAGI rules in the month it was received. If they pay Roger \$800/month on an ongoing basis, this income would also be taxable and would be counted based on MAGI rules regarding rental income.

Note: Income from the sale of inherited property is taxable if the property is sold for more than the fair market value on either the date of the decedent's death or on the alternate valuation date. In Example 9, if Roger were to sell the rental house for \$150,000, the \$50,000 gain would be taxable. If Roger receives income from the sale in a lump sum, this income would only be counted in the month it was received.

Example 10: Darcy inherited her husband's \$150,000 life insurance policy. In most cases, life

insurance policies are not taxable when they are inherited, so the \$150,000 should not be counted as income. However, Darcy receives an ongoing interest payment of \$1,200/month from the policy. This amount is taxable and would be counted as unearned income.

Income generated by an inheritance, bequest, or devise includes situations in which someone is the beneficiary of a trust or estate, and the trust or estate holds assets that are generating income. If the trust or estate distributes income to the beneficiary, the beneficiary is responsible for paying taxes on that income.

Example 11: Keisha is the beneficiary of a trust. Land was given to the trust, and it generates interest that is distributed to Keisha as the beneficiary. Count this interest as unearned income.

44. **Workers' Compensation.**

Under non-MAGI rules, count workers' compensation benefits as unearned income.

Under MAGI rules, do not count workers' compensation benefits. This includes workers' compensation benefits received as a settlement.

*This page last updated in Release Number: 16-01
Release Date: 02/15/2016
Effective Date: 02/15/2016*

[View History](#)

16.3 Income Deductions

[16.3.1 Support Payments](#)

[16.3.2 Pre-Tax Deductions](#)

[16.3.3 Tax Deductions](#)

16.3.1 Support Payments

Under *non-MAGI* rules, deduct the amount of court ordered support a BadgerCare Plus *applicant* /member is obligated to pay for the support or maintenance of another person.

Non- court ordered payments are not deducted. Under *MAGI* rules, child support payments will not be allowed as an income deduction.

The income deduction for a monthly court ordered support expense is the amount that the member is "obligated" to pay as stipulated in the court order. The court ordered obligated amount is allowed even if actual payments are not being made. The deduction can only be made from the income of the person with the court ordered obligation. Do

not allow payments for *arrearages* and annual receipt and disbursement (R & D) expenses.

Actual payments may be deducted for court ordered lying in costs (for the costs of the birth of the child). Unlike monthly court ordered expenses, actual payments for lying in costs are frequently paid at various times and are usually not tied to a regular payment schedule.

Note: If the court order stipulates that the individual must pay a monthly amount toward lying in costs, allow the court ordered monthly amount (obligated amount) as an income deduction. If the member is required to pay lying in costs, but no specific monthly amount is ordered, allow actual payments for lying in costs as an income deduction.

16.3.2 Pre-Tax Deductions

Under MAGI rules, pre-tax deductions will be allowed if the payments are taken out of the individual's paycheck on a pre-tax basis. Examples include but are not limited to:

1. Health Insurance premium payments, including pre-tax premium payments for medical, dental or vision plans
2. Health Savings Account (including flexible spending accounts) contributions
3. Retirement contributions
4. Parking & Transit costs
5. Child Care Savings Account contributions
6. Group Life Insurance premium payments

16.3.3 Tax Deductions

Under MAGI rules, monthly expenses related to the following tax deductions from page one of the IRS Form 1040 will be allowed as income deductions for the current year, even if the individual does not plan on filing taxes. If the expense is not incurred on a monthly basis, it will be prorated and counted as a monthly expense.

Most of these deductions are not common, and they do not include itemized tax deductions, like charitable contributions or mortgage interest.

In addition, a few deductions have caps, as noted in detail below. If an individual reports and verifies a monthly expense that is more than the monthly cap, the deduction will be the amount of the cap.

1. Student Loan Interest

Interest on a loan taken to pay for school expenses for the following persons at the time the loan was taken out:

- His or her spouse;

- His or her child under age 19; or
- His or her child under age 24 who was a student, lived with the individual for more than half a year, did not provide more than half of his or her own support for that year, and did not earn more than \$3,900 during that year.

Do not count interest on a loan used for anything besides paying for education or if a relative or employer gave the loan.

This deduction is capped at a monthly amount of \$208.

2. **Higher Education Expenses** Includes tuition and amounts paid for books or fees, but only if those amounts are required to be paid to the institution as a condition of enrollment or attendance. This deduction may not be claimed for expenses that were paid with tax-free educational assistance. Grants and scholarships used for tuition and fees are generally non-taxable, therefore this deduction cannot be claimed for the portion of tuition and fees that were paid for with grants and scholarships. This is capped at a monthly amount of \$333.
3. **Self-employment Tax Deduction** Applies to individuals who are self-employed, who owe self-employment tax, and who are able to deduct a portion of the self-employment tax they pay. Only deduct the portion that the person can deduct on their tax return (as calculated on Schedule SE), not the entire amount of self-employment tax that is paid.
4. **Spousal Support, Alimony or Maintenance** The amount paid for court ordered spousal support, alimony or maintenance or payments under Section 71 for a current or prior spouse as a result of a legal separation or divorce. Do not deduct more than the court ordered amount. Do not allow any deduction if the court order designates the payments as being non-taxable.
5. **Teachers' Tax-Deductible Expenses** Applies to K-12 teachers who have up to \$250 in out-of-pocket work expenses (expenses not paid for by the employer). This is capped at a monthly amount of \$21.
6. **Self-employed SEP, Simple or Qualified Plan Contributions**
Examples of these plans include:
 - Simplified Employee Pension (SEP) Plan
 - Savings Incentive Match Plan For Employees (SIMPLE)
 - Qualified Plan Contributions
7. **Penalties for Early Withdrawal of Funds** Penalties to a bank or financial institution for withdrawing funds early from a savings account where money must be left in the account for a fixed period of time, such as a time saving account, certificate of deposit (CD) or an annuity.

8. **Performing Artists Tax-deductible Expenses** Applies to performing artists who have out-of-pocket business expenses not paid by the employer and meet the following criteria:
- Worked for at least two employers who each paid at least \$200;
 - Did not earn more than \$16,000 for his or her work in the current year; and
 - Out-of-pocket expenses were more than 10% of his or her earnings.
9. **Military Reserve Members' Tax-deductible Expenses** Applies to travel expenses for members of the Armed Forces Reserve who travel more than 100 miles away from home to perform work for the Armed Forces Reserve.
10. **Out-of-pocket Costs for a Job-related Move** Applies to individuals who paid out-of-pocket expenses for a job-related move and meets the following criteria:
- The move must be for a job-related reason, such as starting a new job, and
 - The new job must be at least 50 miles farther from the individual's old home than the old home was from the individual's old job or must be at least 50 miles from the old home if the individual did not have a job before.
11. **Loss from Sale of Business Property** Applies to self-employed individuals that had a loss from the sale or exchange of property that they owned for their business.
12. **Individual Retirement Account (IRA) Contributions** Applies to individuals who had income from a job and made contributions to an individual retirement account (IRA). Also applies to self-employed individuals who made contributions to an IRA they set up themselves.
13. **Fee-based Official Tax-deductible Expenses** Applies to individuals who are fee-based officials and have out-of-pocket business expenses. Examples of fee-based officials include chaplains, county commissioners, judges, justices of the peace, sheriffs, constables, registrars of deeds or building inspectors.
14. **Domestic Production Activities Deduction** Applies to self-employed individuals who led the production of things like property, electricity, natural gas, or potable water, as long as these things were produced in the United States. This also applies to individuals who invented or created software, recordings, or films in the United States.
- Note:** This deduction is not common.
15. **Allowable Write-in Expenses** These deductions include:
- Contributions to Archer MSAs
 - Deductions attributable to rents and royalties

- Certain deductions of life tenants and income beneficiaries of property
- Jury duty pay given to the employer because the juror was paid a salary during duty
- Reforestation expenses
- Costs involving discrimination suits
- Attorney fees relating to awards to whistleblowers
- Contributions to section 501(c)(18)(D) pension plans.
- Contributions by certain chaplains to section 403(b) plans

*This page last updated in Release Number: 14-04
Release Date: 11/20/14
Effective Date: 11/20/14*

[View History](#)

16.4 EARNED INCOME

Earned income is income from gainful employment.

Under *non-MAGI* rules, earned income for individuals younger than 18 years old is not counted. The gross earned income before any deductions are taken out is counted.

Under *MAGI* rules, earned income after pre-tax deductions will be counted. See [Section 16.3.2 Pre-Tax Deductions](#) for more information on pre-tax deductions.

1. **Contractual Income.**

This provision applies primarily to teachers and other school employees.

When an employed BadgerCare Plus group member is paid under a contract, either written or verbal, rather than on an hourly or piecework basis, the income is prorated over the period of the contract. For example, if the contract is for 18 months, the income is prorated over 18 months no matter the number of installments made in paying the income. The income is prorated even if one of the following is true:

- a. There are predetermined vacation periods
- b. He or she will only be paid during work periods
- c. He or she will be paid only at the end of the work period, season, semester, or school year

2. **Income In-Kind.**

Count in-kind benefits as earned income if they are all of the following:

- a. Regular
- b. Predictable
- c. Received in return for a service or product

Do not count the following:

- a.
 - a. Meals and lodging for armed services members
 - b. In-kind services that do not meet all three of the above criteria

- b. To determine the value of in-kind benefits, use the prevailing wage (but not less than the minimum wage) in the community for the type of work the person does to earn the benefits.

3. **Wage Advances.**

Count advances on wages as earned income in the month received.

4. **Severance Pay.**

Count severance pay as earned income in the month of receipt. Count severance pay that has been deferred at the employee's request or through a mutual agreement with his or her employer as earned income when he or she would have received the amount had it not been deferred.

5. **Workers' Compensation.**

Under non-MAGI rules, count workers' compensation as earned income.

Under MAGI rules, do not count workers' compensation as earned income.

16.4.1 Specially Treated Wages

1. **Income Received by Members of a Religious Order.**

Under non-MAGI rules, count any compensation that a member of a religious

order receives as earned income if the compensation is for gainful employment, even if the compensation is turned back over to the order. Count any compensation that a member of a religious order receives, not related to gainful employment, as unearned income even if the compensation is turned over to the order.

Under MAGI rules, if a person is a member of a religious order and has taken a vow of poverty, do not count any compensation that a member of a religious order receives if the compensation is turned back over to the order.

2. Housing Allowances for Members of the Clergy.

Under MAGI rules, do not count any housing or housing utility allowances that are received as compensation for services as an ordained, licensed, or commissioned minister as income.

3. Jury Duty Payments.

Under non-MAGI rules, count any portion of a jury payment that is over and above expenses as earned income.

Under MAGI rules, count all jury duty payments as earned income for the month in which it is received if the payments are not turned over to the individual's employer. Amounts received separately as reimbursements or allowances for travel to and from the courthouse, meals, and lodging during jury duty are not countable.

4. AmeriCorps.

Under non-MAGI rules, disregard any benefit whether cash or in-kind, including but not limited to living allowance payments, stipends, food and shelter, clothing allowance, and educational awards or payments in lieu of educational awards. Disregard any child care allowance to the extent it was used to meet child care expenses to participate in AmeriCorps. Disregard any basic health insurance policy, child care services, auxiliary aid, and services to people with disabilities and the national service.

Under MAGI rules, earnings or cash benefits received through AmeriCorps, including VISTA, will be counted as earned income. Educational awards received from AmeriCorps are not counted as income.

5. Title V—Older Americans Act of 1965.

Count only wages and salaries paid to individuals as a result of their participation in a program funded under Title V of the Older Americans Act of 1965 as earned income.

These programs include, but are not limited to the following:

- a. Green Thumb.
- b. Experience Works.
- c. The National Urban League.
- d. National Senior Citizens Education and Research Center (Senior Aides).
- e. National Indian Council on Aging.
- f. U.S.D.A. Forest Service.
- g. *WISE*.
- h. Community service employment programs, such as the Older Americans Community Service Program.

Identify programs funded under Title V of the Older Americans Act using documents provided by the member, contacts with the provider, or a local council on aging.

Do not count reimbursements (see [Section 16.2 #19 Reimbursements](#)).

16.4.2 Room and Board Income

Under non-MAGI rules, calculate the net amount by deducting one of the following from the gross amount received from each roomer or boarder: \$15 roomer only, \$111 Boarder only, \$126 roomer and boarder.

Under MAGI rules, these deductions are no longer used if this income is reported as room and board income. If room and board income is reported as self-employment income, see [Section 16.4.3 Self-Employment Income](#) for more information on counting self-employment income.

16.4.3 Self-Employment Income

Self-employment income is income derived directly from one's own business rather than as an employee with a specified salary or wages from an employer. "Business" means an occupation, work, or trade in which a person is engaged as a means of livelihood.

A business is operating when it is ready to function in its specific purpose. The period of operation begins when the business first opens and generally continues uninterrupted up to the present. A business is operating even if there are no sales and no work is being performed. Thus a seasonal business operates in the off season unless there has been a significant [change in circumstances](#).

A business is not operating when it cannot function in its specific purpose. For instance, if a mechanic cannot work for four months because of an illness or injury, he may claim his business was not in operation for those months.

Self-employment is identified according to the following criteria:

Organization

A farm or other business is organized in one of three ways:

1. A sole proprietorship, which is an unincorporated business owned by one person.
2. A partnership, which exists when two or more persons associate to conduct business. Each person contributes money, property, labor, or skills and expects to share in the profits and losses. Partnerships are unincorporated.
3. A corporation is a legal entity authorized by a state to operate under the rules of the entity's charter. There may be one or more owners. A corporation differs from the other forms because a corporation:
 - a. Is taxed as a separate entity rather than the owners being taxed as individuals, and
 - b. Provides only limited liability. Each owner's loss is limited to their investment in the corporation while the owners of unincorporated business are also personally liable.

IRS Tax Forms

A self-employed person who earns more than \$400 net income must file an end-of-year return. A person who will owe more than \$400 in taxes at the end of the year must file quarterly estimates.

IRS tax forms for reporting self-employment income are listed below.

- Form 1065—Partnership
- Form 1120—Corporation
- Form 1120S—S Corporation
- Form 4562—*Depreciation* and Amortization
- Form 1040—Sole Proprietorship
 - Schedule C (Form 1040)—Business (non-farm)
 - Schedule E (Form 1040)—Rental and Royalty
 - Schedule F (Form 1040)—Farm Income
 - Schedule SE (Form 1040)—Social Security Self-Employment

Employee Status

A person is an employee if he or she is under the direct "wield and control" of an employer. The

employer has the right to control the method and result of the employee's service. A self-employed person earns income directly from his or her own business, and:

1. Does not have federal income tax and FICA payments withheld from a paycheck.

Note: A babysitter who works in someone else's home is considered an employee of that household even if the individual employing him or her does not withhold taxes or FICA.

2. Does not complete a W-4 for an employer.
3. Is not covered by employer liability insurance or workers' compensation.
4. Is responsible for his or her own work schedule.

Examples of self-employment are:

- a. Businesses that receive income regularly (for example, daily, weekly, or monthly):
 - i. Merchant.
 - ii. Small business.
 - iii. Commercial boarding house owner or operator.
 - iv. Owner of rental property.
- b. Service businesses that receive income frequently and possibly sporadically:
 - i. Craft persons.
 - ii. Repair persons.
 - iii. Franchise holders.
 - iv. Subcontractors.
 - v. Sellers of blood and plasma.
 - vi. Commission sales persons (such as door-to-door delivery).
- c. Businesses that receive income seasonally:
 - i. Summer- or tourist-oriented business.
 - ii. Seasonal farmers (custom machine operators).
 - iii. Migrant farm worker crew leaders.
 - iv. Fishers, trappers, or hunters.
 - v. Roofers.
- d. Farming, including income from cultivating the soil or raising or harvesting any agricultural commodities. It may be earned from full-time, part-time, or hobby farming.

16.4.3.1 Income Sources

Self-employment income sources are:

1. **Business.**

Income from operating a business.

2. Capital Gains.

Business income from selling securities and other property is counted. Under non-MAGI rules, personal capital gains are not counted as income. Under MAGI rules, personal capital gains and ordinary gains or losses are counted as unearned income. See [Section 16.5 Other Income](#) for more information.

3. Rental.

Rental income is rent received from properties owned or controlled. Rental income is either earned or unearned. It is earned only if the owner actively manages the property on an average of 20 or more hours per week. It is unearned when the owner reports it to the IRS as other than self-employment income. Use "net" rental income in the eligibility determination. "Net" rental income means gross rental receipts minus business expenses.

When a Medicaid group member reports rental income to the IRS as self-employment income, see [3A Reported to IRS as Self Employment Income](#).

If he or she does not report it as self-employment income, add "net rent" to any other unearned income on the appropriate worksheet. Determine "net rent" as detailed in [3B Rental Income Not Reported as Self-Employment Income](#).

3A Reported to IRS as Self-Employment Income

When the owner is not an occupant, net rental income is the rent payment received minus the interest portion of the mortgage payment and other verified operational costs.

When a life estate holder moves off the property and the property is rented, net rental income is the rent payment received minus taxes, insurance, and operational costs. The operational costs are the same as the costs the holder was liable for when living on the property.

When the owner lives in one of the units of a multiple unit dwelling and does not file taxes for the rental income, compute net rental income as follows:

1. Add the interest portion of the mortgage payment and other operational costs common to the entire operation.
2. Multiply the number of rental units by the total in step 1.

3. Divide the result in step 2 by the total number of units to get the proportionate share.
4. Add the proportionate share to any operational costs paid that are unique to any rental unit. This equals total expenses.
5. Subtract total expenses from the total rent payments to get net rent.

3B Rental Income Not Reported as Self Employment Income

When a BadgerCare Plus group member reports rental income to the IRS as self-employment income, see 3A.

If he or she does not report it as self-employment income, add "net rent" to any other unearned income on the appropriate worksheet. Determine "net rent" as follows:

1. When the owner is not an occupant, "net rent" is the rent payment received minus the interest portion of the mortgage payment and other verifiable operational costs. Operational costs include ordinary and necessary expenses such as insurance, taxes, advertising for tenants, and repairs. Repairs include such expenses as repainting, fixing gutters or floors, plastering, and replacing broken windows.

Capital expenditures are not deductible from gross rent. A capital expenditure is an expense for an addition or increase in the value of the property. It would include improvements such as finishing a basement; adding a room; putting up a fence; putting in new plumbing, wiring, or cabinets; or paving a driveway.

If an institutionalized person has excess operational costs above the monthly rental income, carry the excess costs over into later months until they are offset completely by rental income. But do the carryover only until the end of the year in which the expenses were incurred.

When a life estate holder moves off the property and the property is rented, count the net rental income the holder is entitled to receive. Net rental income is the gross rental income minus taxes, insurance, and other operational costs. The operational costs are the same as the costs the holder was liable for when living on the property.

2. When he or she receives income from a duplex, triplex, etc. and lives in one of the units, determine "net rent" as follows:
 - a. Add the interest portion of the mortgage payment and other verifiable operational costs common to the entire operation.

- b. Multiply the number of rental units by the total in "a."
- c. Divide the result in "b." by the total number of units. This is the proportionate share.
- d. Add the proportionate share, "c.," to any operational costs paid by the member that are unique to any rental unit. The result is the total member expense.
- e. Subtract the total member expense, "d.," from the total rent payments to get "net rent."

4. Royalties.

Royalty income is unearned income received for granting the use of property owned or controlled. Examples are patents, copyrighted materials, or a natural resource. The right to income is often expressed as a percentage of receipts from using the property or as an amount per unit produced. See [Section 16.5 Other Income](#) for more information on counting royalty income.

16.4.3.2 Calculating BadgerCare Plus Self-Employment Income

Calculate BadgerCare Plus income in one of the following ways:

1. Using IRS tax forms ([Section 16.4.3.2.1 IRS Tax Forms](#)) completed for the previous year
2. Anticipating earnings ([Section 16.4.3.2.4 Anticipating Earnings](#))

16.4.3.2.1 IRS Tax Forms

Do not fill out any IRS tax forms (or the Self-Employment Income Report form, [F-00107](#)) yourself. This is the responsibility of the member.

Consult IRS tax forms only if all of the following are true:

- The business was in operation at least one full month during the previous tax year.
- The business has been in operation six or more months at the time of the *application*.
- The person does not claim a change in circumstances since the previous year.

If all three conditions are not met, use anticipated earnings ([Section 16.4.3.2.4 Anticipating Earnings](#)).

16.4.3.2.2 Worksheets

If you decide to use IRS tax forms, use them together with the self-employment income worksheets ([F-16034](#), [F-16035](#), [F-16036](#), [F-16037](#), and [F-16037A](#)).

The worksheets identify net income and depreciation by line on the IRS tax forms.

For each operation, select the worksheet you need and, using the provided tax forms and/or schedule, complete the worksheet. These are:

1. Sole Proprietor—Farm and Other Business
 - a. IRS Schedule C (Form 1040)—Non-farm Business Income
 - b. IRS Schedule E (Form 1040)—Rental and Royalty Income
 - c. IRS Schedule F (Form 1040)—Farm Income
 - d. IRS Form 4797—Capital & Ordinary Gains
2. Partnership
 - a. IRS Form 1065—Partnership Income
 - b. IRS Schedule K-1 (Form 1065)—Partner's Share of Income
3. Corporation

IRS Form 1120—Corporation Income
4. Subchapter S Corporation
 - a. IRS Form 1120S—Small Business Corporation Income
 - b. IRS Schedule K-1 (Form 1120S)—Shareholder's Share of Income

Next, divide *IM* income by the number of months that the business was in operation during the previous tax year.

The result is monthly *IM* income. Add this to the fiscal test group's other earned and unearned income. If monthly *IM* income is a loss, add zero to the non-self-employment income.

When a household has more than one self-employment operation, the losses of one may be used to offset the profits of another. Apply this offset only to those self-employment operations that produced earned income. Do not apply a loss from unearned income to a gain in earned income. Losses from self-employment cannot be used to offset other earned or unearned income. Under non-MAGI rules, losses from self-employment cannot be used to offset other earned or unearned income. Under MAGI rules, losses from self-employment can be used to offset other income types.

If you use more than one worksheet because there is more than one operation, combine the results of each worksheet into one monthly *IM* income amount before adding that total to any

other income. Remember that while a salary or wage paid to a test group member is an allowable business expense, you must count it as earned income to the payee.

Continue to process the group through the balance of the handbook, including some additional work-related expenses that the IRS does not allow as business expenses.

16.4.3.2.3 Disallowed Expenses

Generally, expenses that are allowed by the IRS on business tax forms are considered allowed expenses for BadgerCare Plus. However, under non-MAGI rules, some specific expenses are allowed in the calculation of self-employment income on IRS tax forms but are not allowed for BadgerCare Plus. Under MAGI rules, countable self-employment income will be the same as the net self-employment taxable income.

Depreciation and Depletion

Effective February 1, 2014, for new BadgerCare Plus applicants and effective April 1, 2014, for existing BadgerCare Plus members, depreciation and depletion expenses will be allowable expenses.

Under non-MAGI rules, the following expenses are not allowed for BadgerCare Plus:

- Net loss carryover from previous periods (long-term capital loss)
- Federal, state, and local income taxes
- Charitable donations
- Work-related personal expenses, such as transportation to and from work
- Employer work-related personal expenses, such as pensions, employee benefit and retirement programs, and/or profit sharing expenses. (Business expenses for employees' pensions, benefits, retirement programs, and profit sharing expenses are allowable, but the work-related personal expenses of the employer are not.)
- The purchase price of income producing real estate, capital assets/equipment, and durable goods or payments on the principal of loans for the purchase of these assets.
- Guaranteed payments to partners

Under MAGI rules, the following expenses will continue to not be allowed for BadgerCare Plus:

- Charitable donations
 - Work-related personal expenses, such as transportation to and from work
 - Employer work-related personal expenses, such as pensions, employee benefit and retirement programs, and/or profit sharing expenses. (Business expenses for employees' pensions, benefits, retirement programs, and profit sharing expenses are allowable, but the work-related personal expenses of the employer are not.)

- Principal portion of mortgage payment

16.4.3.2.4 Anticipating Earnings

If past circumstances do not represent present circumstances, calculate self-employment income based on anticipated earnings. A change in circumstances is any change that can be expected to affect income over time. It is the person's responsibility to report changes.

The date of an income change is the date you agree that a change occurred. You must also judge whether the person's report was timely to decide if the case was over or underpaid. Changes are then effective according to the normal prospective budgeting cycle. Do not recover payments made before the agreed on date.

The following are other instances when you would use anticipated earnings:

1. The business was not operating at least one full month during the previous tax year.
2. The business was not operating six or more months at the time of the interview.

The following are examples of changed circumstances:

- The owner sold or simply closed down the business.
- The owner sold a part of his business (e.g., one of two retail stores).
- The owner is ill or injured and will be unable to operate the business for a period of time.
- A plumber gets the contract on a new apartment complex. The job will take nine months, and his or her income will increase.
- A farmer suffers unusual crop loss due to the weather or other circumstances.
- There is a substantial cost increase for a particular material such that there will be less profit per unit sold.
- Sales, for an unknown reason, are consistently below previous levels. The relevant period may vary depending on the type of business (consider normal sales fluctuations).

The Self-Employment Income Report form ([F-00107](#)) simplifies reporting income and expenses when earnings must be anticipated. It is modeled after IRS Form 1040, Schedule C, and can be used to report income for any type of business with any form of organization. However, some, especially farm operators, may find it easier to complete the IRS tax form when income and expense items are more complex.

To compute anticipated earnings, the person must complete a Self-Employment Income Report form for those months of operation since the change in circumstances occurred following the guidelines below (remember, the beginning of a business is a change in circumstances). He or

she may complete the Self-Employment Income Report form for each month separately or combine the months on one Self-Employment Income Report form.

When a new self-employment business is reported or when a change in circumstance occurs and the past circumstances no longer represent the present, recalculate self-employment income:

1. When two or more months of actual self-employment information is available, calculate a monthly self-employment net income average using all of the actual income information beginning from the date self-employment began or the date of the significant change. See Example 1 below.
2. When at least one full month but less than two full months of actual self-employment income information is available, calculate a monthly net income average using the actual net income received in any partial month of operation, the one full month of operation, and an estimate of net income for the next month. See Example 2 below.
3. When there is less than one full month of actual income information available, calculate a monthly net self-employment income average using the actual net income received in the partial month (since the change in circumstance occurred) and estimated income and expenses for the next two months. See Example 3 below.

Use the average until the person's next review or if a significant change in circumstances is reported between reviews.

Example 1: Bonnie applies for Child Care and BadgerCare Plus on April 5, 2007. She reports that she started self-employment in January 2007. The agency uses a Self-Employment Income Report form for January, February, and March to determine the prospective self-employment income estimate for Bonnie's BadgerCare Plus and Child Care certification period (April 2007-March 2008).

On Bonnie's September *SMRF*, no change in self-employment income is reported, and the worker continues to use the average determined at the time of application.

Example 2: Ricardo is applying for FoodShare and BadgerCare Plus eligibility on February 5, 2007. He started self-employment on December 15. To calculate his prospective self-employment income, he completes a Self-Employment Income Report form for December, January, and February including his actual and expected income and expenses for three months. The worker divides this total by three to determine an anticipated monthly average income amount. This amount is used until a change in self-employment is reported or until Ricardo completes a new application or a review.

Example 3: Jenny is a BadgerCare Plus member and Child Care recipient who has been self-employed as a hair dresser since 2002. Jenny's BadgerCare Plus and Child Care

certification period is December 2006 to November 2007. The worker used Jenny's 2005 tax return to establish a monthly income amount.

In March 2007, Jenny reports that she has been unable to work since breaking her arm on February 17. She is not sure when she will be able to return to work, but it will not be until at least May. The worker has Jenny complete a Self-Employment Income Report form for February 17-February 28 (actual income since the change in circumstance occurred) and for March and April using the best estimate of income to establish her prospective self-employment income. The worker will use these three months to determine a prospective self-employment income estimate for the remainder of the certification period. Jenny does not need to submit any additional Self-Employment Income Report forms.

Use the anticipated earnings amount until the person completes an IRS tax form or reports a change in circumstances.

16.4.3.3 Losses Offsetting Other Income (MAGI Rules Only)

Under MAGI rules, losses from self-employment can be used to offset the individual's other income types. In situations where an individual is planning to file a joint tax return with his or her spouse, losses from self-employment may offset the spouse's income.

16.4.4 Verification

Self-employment income is not available through data exchange and is therefore questionable (see [Section 9.10 Questionable Items](#)). Completed and signed IRS tax forms (see [Section 16.4.3.2.1 IRS Tax Forms](#)) are sufficient verification of farm and self-employment income. If anticipated earnings are used, a completed and signed Self-Employment Income Report form is sufficient verification.

It is not necessary to collect copies of supportive items such as receipts from sales and purchases. However, you can require verification when the information given is in question. Document the reason for the request.

16.4.4.1 Self-Employment Hours

Count the time a self-employed person puts in on business-related activities involving planning, selling, advertising, and management along with time put in on production of goods and providing of services as hours of work.

*This page last updated in Release Number: 16-01
Release Date: 02/15/2016
Effective Date: 02/15/2016*

[View History](#)

16.5 Other Income

1. [Unemployment Compensation \(UC\)](#)
2. [Child Support](#)
3. [Social Security Benefits](#)
4. [Federal Match Grants for Refugees](#)
5. [Gifts](#)
6. [Money From Another Person](#)
7. [Land Contract](#)
8. [Loans](#)
9. [Profit Sharing](#)
10. [Retirement Benefits](#)
11. [Sick Benefits](#)
12. [Trusts](#)
13. [Gambling Winnings](#)
14. [Royalties](#)
15. [Capital and Ordinary Gains and Losses](#)
16. [Student Financial Aids](#)

Other income is any payment that the member receives from sources other than employment. Unless it is disregarded income, count the gross payment in the person's income total.

1. **Unemployment Compensation (UC)** - Count UC that is intercepted to collect child support as if the UC beneficiary actually received the intercepted dollars.

2. **Child Support**

Under *non-MAGI* rules, count child support income as unearned income.

Under *MAGI* rules, do not count child support income. If a household is receiving family support, divide the payment by the number of members in the household. The amount of the payment allocated to the child(ren) is considered child support and is disregarded. Count the amount of the payment allocated to the adult(s) as alimony/spousal support unless the divorce/separation order by the court designates the spousal support payments as being non-taxable. If the spousal support payments are non-taxable, they are exempt under MAGI rules.

3. **Social Security Benefits** - Count Social Security Benefits as unearned income in the month received.

Supplemental Security Income (SSI) is not counted ([16.2.33](#)).

The following is a brief list of the potential codes that should be used in coding Social Security income types:

SSDC - Social Security Disabled Child
 SSDI - Social Security Disability/Wage Earner
 SSDW - Social Security Disability/Wife
 SSRE - Social Security Retirement
 SSSC - Social Security Surviving Child
 SSSS - Social Security Surviving Spouse
 SSWW - Social Security Disabled Widow(er)

Under *MAGI* rules, although Social Security Benefits are not taxable, they must be counted as unearned income. However, Social Security Benefits are not considered when determining if an individual is “expected to be required” to file a tax return for the current year. See section [2.7.2](#) for more information.

4. **Federal Match Grants for Refugees** - Some refugee resettlement agencies have grants available for refugees for their second, third, and fourth month after arrival in the U.S. These are cash grants and can vary in the amount issued. Under *non-MAGI* rules, count these payments as unearned income. Under *MAGI* rules, do not count this income.

5. **Gifts** - A gift is something a person receives which is not repayment for goods or services the person provided and is not given because of a legal obligation on the giver’s part. To be a gift, something must be given irrevocably (that is, the donor relinquishes all control).

Under *non-MAGI* rules, count Monetary gifts over \$30 a calendar quarter. A Calendar quarter is three consecutive months beginning with January, April, July or October.

Under *MAGI* rules, do not count the value of property received as a gift as income. Count a gift as income in the month received if it meets either of the following criteria:

- Income from a bequest, devise or inheritance
- Income generated from property given to a trust if the income is paid, credited or distributed to the individual

Example 1: Keisha is the beneficiary of a trust. Land was given to the trust, and it generates interest that is distributed to Keisha as the beneficiary. Count this interest as unearned income.

6. **Money from Another Person** is money a person receives which is not repayment for goods or services the person provided and is not given because of a legal obligation on the giver’s part. This is not a loan.

Under *non-MAGI* rules, count money from another person if the amount is over \$30 a calendar quarter. A Calendar quarter is three consecutive months beginning with January, April, July or October.

Under **MAGI** rules, count money from another person as income in the month received only if it meets either of the following criteria:

- Income from a bequest, devise or inheritance
- Income generated from property given to a trust if the income is paid, credited or distributed to the individual

Example 2: Mimi receives \$500 each month from her parents. She is not expected to pay back this money. Mimi's BadgerCare Plus eligibility is determined using MAGI rules. The \$500 is not counted as income for BadgerCare Plus eligibility.

Note: If the money is received from another person in exchange for goods or services (such as an informal arrangement in which someone rents a room in his or her house), and if the payment is regular and predictable, it should be counted under both MAGI and non-MAGI rules. See Chapter 16.4.3.1 for information on counting rental income.

Example 3: Jeremy pays Micah \$300 each month to live in a room in Micah's house. Micah and Jeremy do not have a formal lease agreement, but the payment is regular and predictable. Count the \$300/month as income for BadgerCare Plus eligibility.

7. **Land Contract** - Count any portion of monthly payments received that are considered interest from a land contract as unearned income. Do not count the principal as income, because it is the conversion of one asset form to another. Deduct from the gross amount any expenses the person is required to pay by the terms of the contract.

If the income is received less often than monthly, prorate the income to a monthly amount. Do not begin budgeting this monthly amount until the person first receives a payment after becoming eligible.

Example 1: Bob receives land contract payments from Farmer Brown twice a year, one \$500 payment in March and another \$500 payment in September.

If Bob is applying in February prorate the land contract payments Bob receives after he becomes eligible. In March when Bob receives a \$500 land contract payment, divide the total income (\$500) by the frequency of the payments (six months) to get the budgeted income amount of \$83.33 per month ($\$500/6 \text{ months} = \83.33).

Begin budgeting this amount in March.

8. **Loans** - If an BadgerCare Plus member makes a loan (except a land contract), treat the repayments as follows:
- a. Count the interest as unearned income in the month received. In the months following the month the interest payment was received, count the interest payment as an asset.

b. **Do not count any repayments** toward the principal of the loan, whether it is a full payment, a partial payment, or an installment payment, as an asset.

If an AG member receives a loan and it is available for current living expenses, count it as an asset. Do this even if there is a repayment agreement. If it is not available for current living expenses, disregard it.

9. **Profit Sharing** - Count profit sharing income as unearned income in the month received. Tax-deferred contributions made to a profit-sharing plan are not taxable and are not counted as income.

10. **Retirement Benefits** - Retirement benefits include work-related plans for providing income when employment ends (e.g. pension disability or retirement plans administered by an employer or union).

Other examples of retirement funds include accounts owned by the individual, such as Individual Retirement Accounts (IRA) and plans for self-employed individuals, sometimes referred to as KEOGH plans.

Under *non-MAGI* rules, periodic payments made from a work-related retirement benefit plan should be counted as income in the month of receipt. Payments from an ineligible spouse's work related pension account are also counted as income to the ineligible spouse.

Any periodic payments from individually owned accounts (e.g., IRA) should not be counted as income in the month of receipt. They are considered the same as withdrawals from an applicant's savings account.

Consider IRAs, Keoghs, or other retirement funds that are completely cashed in as a conversion from one asset form to another. BadgerCare Plus does not count assets in eligibility determinations.

Under *MAGI* rules, count the taxable portion of any retirement distribution as unearned income.

11. **Sick Benefits** -

Under *non-MAGI* rules, count Sick benefits received from an insurance policy such as an income continuation policy as unearned income.

Under *MAGI* rules, count sick benefits received from an insurance policy if the individual's employer contributed or paid for the benefit. Do not count the following:

- Reimbursement for medical care;
- Payments for loss of a member or bodily function, or permanent disfigurement; or

- Amounts computed with reference to the injury but not with respect to the individual's absence from work.

12. **Trusts** - A trust is any arrangement in which a person (the "grantor") transfers property to another person with the intention that person (the "trustee") hold, manage, or administer the property for the benefit of the grantor or of someone designated by the grantor (the "beneficiary").

The term "trust" includes any legal instrument or device or arrangement which, even though not called a trust under state law, has the same attributes as a trust.

That is, the grantor transfers property to the trustee and the grantor's intention is that the trustee holds, manage, or administer the property for the benefit of the grantor or of the beneficiary.

The grantor can be:

- a. The BadgerCare Plus member.
- b. The spouse of the BadgerCare Plus member.
- c. A person, including a court or administrative body, with legal authority to act in place of or on behalf of the member or the member's spouse. This includes a power of attorney or guardian.
- d. A person, including a court or an administrative body, acting at the direction or upon the request of the member or the member's spouse. This includes relatives, friends, volunteers or authorized representatives.

All regular payments, excluding dividends and interest, made under the terms of the trust, from the trust to the beneficiary are unearned income to the beneficiary.

13. **Gambling Winnings**

Under *non-MAGI* rules, gambling winnings are counted as unearned income in the month of receipt. Gambling losses cannot be used to offset the winnings.

Under *MAGI* rules, count gambling winnings that are regular and predictable as income. Gambling losses cannot be used to offset other types of income.

14. **Royalties** - Count Royalty income is as unearned income. Royalties are payments received for granting the use of property owned or controlled. Examples are patents, copyrighted materials or a natural resource. The right to income is often expressed as a percentage of receipts from using the property or as an amount per unit produced.

15. **Capital and Ordinary Gains and Losses**

Under *non-MAGI* rules, do not count personal capital and ordinary gains or losses.

Under *MAGI* rules, if personal capital gains are regular and predictable, count as

unearned income. Personal capital losses can be used to offset the individual's other income types. In situations where an individual is planning to file a joint tax return with his or her spouse, personal capital losses may offset the spouse's income.

16. Student Financial Aids

Under non-MAGI Rules, student financial aids are not counted as income regardless of source. This includes student loans, grants, scholarships and work study, and any financial assistance provided by a public or private organization for the purpose of obtaining an education. Disregard the full amount of student financial aids, including any amounts earmarked for living expenses. Count income from an internship or assistantship that is not part of work study or another student aid as earned income. Count Income from an internship or assistantship that is not part of work study or another student aid, counts the income from the internship or assistantship as earned income.

Example 4: Clark is a journalism student. The University School of Journalism has arranged an internship for him to work 10 hours a week at The Daily Planet. The newspaper pays him \$30 a week. Count this as earned income when you are determining Clark's eligibility.

Under MAGI Rules, work study income and any income from an internship or assistantship should be counted as earned income. Grants, scholarships, fellowships and any additional financial assistance provided by public or private organizations that exceed the cost of tuition, books and mandatory fees are counted as unearned income and should be pro-rated over the period of time they are intended to cover. Student loans are not counted as income irrespective of what the loan is used to pay for.

Example 5: Mary was awarded a scholarship for \$3,500 in July that is intended to cover her fall semester (September through December). Her tuition and course related expenses are \$3,250 for the semester. The \$250 that exceeds the amount of tuition and course-related expenses will be pro-rated over the four month period from September through December at \$62.50 in unearned income each month ($\$250/4 \text{ months} = \$62.50/\text{month}$).

Types of grants, scholarships and fellowships counted as income include:

- Pell Grants,
- Robert Byrd Honors scholarships,
- Any grants, scholarships or fellowships received from the college or university as part of a financial aid package,
- Any grants, scholarships or fellowships provided by public or private organizations.

The following educational aid types are not counted as income:

- Loans, including Stafford Loans and Perkins Loans,
- AmeriCorps or HealthCorps grant,
- Bureau of Indian Affairs grant,
- GI Bill / Veterans benefits,

- ROTC benefits.

Note: These income types will not be considered when determining if grants, scholarships and fellowships exceed the cost of tuition, books and mandatory fees.

The following expense types will be used to offset income from grants, scholarships, fellowships and other financial aid:

- Tuition,
- Required books, supplies or equipment,
- Mandatory fees

The following expense types will not be allowed to offset income from grants, scholarships or other financial aid:

- Room,
- Board (meals or meal plans),
- Personal expenses,
- Transportation and parking,
- Loan fees,
- Health insurance costs.

*This page last updated in Release Number: 14-04
Release Date: 11/20/14
Effective Date: 11/20/14*

[View History](#)

16.6 FLUCTUATING INCOME

If the amount or frequency of regularly received income is known, average the income over the period between payments. If neither the amount nor the frequency is predictable, do not average; count income only for the month in which it is received.

*This page last updated in Release Number: 07-01
Release Date: 10/29/07
Effective Date: 02/01/08*

[View History](#)

16.7 Prorating Income

Income received on a yearly basis or less often than monthly, that is predictable in both amount and frequency, must be converted to a monthly amount or prorated.

Prorate means "to distribute proportionately."

Example 1: Sally receives a \$1,500 royalty payment quarterly. This payment should be prorated for the months between payments. \$1,500 is distributed over three months by dividing the amount of money by the number of months between payments. The prorated amount is $\$1,500/3 = \500 a month.

Prorating is applied to a member's income when the income is received less often than monthly. By prorating, income is distributed evenly over the number of months between payments

When an assistance group applies, do not count the prorated income until it is received.

Example 2: Joe receives semi-annual land contract installments of \$900. This equals a monthly income of \$150 (\$900 prorated over six months). He becomes eligible in May. He receives payments in January and July each year. Do not budget any prorated income until July, the first month of receipt after Joe becomes eligible.

If the group becomes ineligible and reapplies before they receive the next installment, use the same prorated amount as before.

*This page last updated in Release Number: 07-01
Release Date: 10/29/07
Effective Date: 02/01/08*

[View History](#)

16.8 Migrant Worker's Income

Use annualized earned income for migrant worker's income. "Annualized earned income" is a prospective monthly estimate of earned income based on the estimated total gross annual earnings divided by 12. Annualized income can be based on the past 12 months of the migrant family's income if it is anticipated that last year's income is the best estimate of the current year's prospective income.

*This page last updated in Release Number: 07-01
Release Date: 10/29/07
Effective Date: 02/01/08*

17 Deductibles

[View History](#)

17.1 DEDUCTIBLES

Through March 31, 2014 children (under age 19) with income above 150% of the FPL who have access to insurance can qualify for BadgerCare Plus by meeting a deductible.

Effective April 1, 2014, children (under age 19) with income over 300% FPL (*non-MAGI* rules) or 306% (*MAGI* rules) may become eligible for BadgerCare Plus by meeting a deductible. Children with income over 150% FPL (*non-MAGI* rules) or 156% FPL (*MAGI* rules) who are denied BadgerCare Plus solely due to access to health insurance may also become eligible for BadgerCare Plus by meeting a deductible. The deductible amount is calculated for a six-month period using the amount of income that exceeds 150% FPL.

Pregnant women with incomes above 300% FPL (under non-MAGI rules) or 306% FPL (under MAGI rules) can qualify for BadgerCare Plus by meeting a deductible. The deductible amount is calculated for a six month period using the amount of income that exceeds 300% FPL for pregnant women. The deductible is met by incurring medical expenses that equal the deductible amount.

Note: When determining the deductible amount under MAGI rules, only the income of the member, the member's spouse, and if the member is under age 19, the member's parents should be considered. If a sibling's or tax dependent's income has been counted as part of the applicant's regular MAGI assistance group, it should be excluded for purposes of calculating the deductible. Do not change the group size for the MAGI assistance group.

*this page last updated in Release Number: 14-01
Release Date: 02/07/14
Effective Date: 02/01/14*

[View History](#)

17.2 PREGNANT WOMEN

[17.2.1 Introduction](#)

[17.2.2 Deductible Period](#)

[17.2.3 Calculating the Deductible Amount](#)

17.2.1 Introduction

The *deductible* amount for a pregnant woman is the amount of countable income above 300% FPL for a six month period. To meet the deductible she or other family members included in the BadgerCare Plus group must incur medical bills equal to her deductible amount. If she applied prior to February 1, 2014, when the deductible is met she will be covered under the Benchmark plan through March 31, 2014 with no premium until two

months after giving birth. Effective February 1, 2014, all pregnant women who are applying for BadgerCare Plus, including those eligible through deductibles, will be covered under the Standard Plan.

Note: For eligibility regarding BadgerCare Prenatal for inmates of a public institution or *non-qualifying immigrants*, see [41.2](#) for that specific policy.

Note: If there is more than one pregnant woman in the BadgerCare Plus group, all of them become eligible when a deductible is met.

Through March 31, 2014, a self-employed pregnant woman with assistance group income over 300% FPL, who is also the parent or caretaker relative of a child, does not have to meet a deductible. She is eligible with no premium under the Benchmark plan. If she is not the parent or caretaker relative of a born child, she would have to meet a deductible to become eligible for BadgerCare Plus.

Beginning April 1, 2014, a pregnant woman with assistance group income over 300% FPL must meet a deductible to become eligible for BadgerCare Plus, regardless of if she is self-employed or a parent or caretaker of born children. She will be eligible for coverage under the Standard Plan once she meets the deductible.

Effective January 1, 2014, a pregnant minor with family income over 300% FPL (under non-MAGI rules) or 306% FPL (under MAGI rules) has the option to either prepay the pregnancy deductible or to wait to meet the deductible.

If the pregnant woman applies after the birth of her baby and becomes eligible by meeting a deductible in the back dated months, she is only eligible as a pregnant woman until the end of the month she gives birth.

Example: Janet applies for BadgerCare Plus in July and requests a BadgerCare Plus deductible period from April through September. She gave birth on June 30th. Janet paid the full deductible amount, so is certified from April 1st through June 30th. She should be tested as a caretaker relative effective July 1st if she is living with the newborn or any other child under her care.

Note: Effective April 1, 2014, if Janet has no children living with her, she can also be tested for BadgerCare Plus eligibility as a childless adult.

17.2.2 Deductible Period

The pregnant woman can choose to begin the BadgerCare Plus deductible period as early as three months prior to the month of *application*, and as late as the month of application.

A pregnant woman can choose a BadgerCare Plus deductible period which includes a month in which, if he or she had applied, he or she would have been ineligible for a non-financial reason. Although excess income is still calculated over a six month period, the individual can only be certified for BadgerCare Plus during the dates when he or she was non-financially eligible.

Example 1: Luanne applied for BadgerCare Plus on June 1st and requests a BadgerCare Plus deductible period from April through September. She gave birth on June 2nd and gave the baby up for adoption. Luanne paid the full deductible amount, so is certified from April 1st through June 30th.

A new deductible period can be established at any time before the current deductible has been met.

Example 2: Julie is pregnant and due November 15th. She applied for BadgerCare Plus April 1st and a deductible period was set up for April through September. She did not incur enough expenses to meet the deductible. In July, Julie's income decreased and she requested a new deductible period from July through November. Because she had not met the original deductible, the new deductible period could be established.

A pregnant woman who is ineligible for excess income in some backdate months, but has no excess income in others, does not have to choose to have a BadgerCare Plus deductible. She can choose to be certified in the months she is eligible and to accept the ineligibility of the other months when she had excess income.

Example 3: Rachel is pregnant and applied for BadgerCare Plus in July. She had no income and did not expect any income in the future. She was eligible in July. She also requested BadgerCare Plus eligibility for April to cover some medical expenses she had in April. In April and May she had income in excess of 300% of the FPL. In June she would have been eligible because she had no income.

In April and May her income was over 300% of FPL by \$200 a month. She has 2 choices:

1. Choose a BadgerCare Plus deductible period of April through September. After meeting the BadgerCare Plus deductible of \$400 she would be certified for BadgerCare Plus from April through September or 60 days past the birth of her baby, with no premium.
2. Not choose a BadgerCare Plus deductible period. She would not have to meet a BadgerCare Plus deductible. She could be certified immediately for June through 60 days past the birth of her baby but would have to forego BadgerCare Plus for May and June because of the excess income in May and June.

17.2.3 Calculating the Deductible Amount

To calculate the dollar amount of the BadgerCare Plus deductible for a pregnant woman under *non-MAGI* rules:

1. Determine the BadgerCare Plus deductible period
2. Find the BadgerCare Plus group's total countable income for each month in the deductible period.
3. Compare the total income of each month with 300% FPL. If a month's income is less than or equal to 300% FPL, ignore it. If a month's income is more than the income limit, find the excess income by subtracting the income limit from the income of that month.
4. Add together the excess income of the months in the deductible period.
The result is the pregnant woman's BadgerCare Plus deductible amount.

When calculating a deductible amount for backdated months, use the actual, not prospective, income received in the backdated months.

To calculate the dollar amount of the BadgerCare Plus deductible for a pregnant woman under *MAGI* rules:

1. Determine the BadgerCare Plus deductible period
2. Find the BadgerCare Plus group's total countable income for each month in the deductible period.
3. If the assistance group's total countable income include the income of someone other than the pregnant woman, her spouse, or if she under age 19, her parents, subtract the income of that person, but do not change the group size of the AG.
4. Compare the total income of each month with 300% FPL. If a month's income is less than or equal to 300% FPL, ignore it. If a month's income is more than the income limit, find the excess income by subtracting the income limit from the income of that month.
5. Add together the excess income of the months in the deductible period.
The result is the pregnant woman's BadgerCare Plus deductible amount.

When calculating a deductible amount for backdated months, use the actual, not prospective, income received in the backdated months.

*this page last updated in Release Number: 14-03
Release Date: 09/05/14
Effective Date: 02/01/14*

[View History](#)

17.3 CHILDREN UNDER 19

[17.3.1 Deductible Period](#)

[17.3.2 Calculating the Deductible Amount](#)

The *deductible* amount for a child under 19 is the amount of countable income above 150% FPL for a 6 month period.

Under *MAGI* rules, to meet the deductible, the child or his or her parents included in the child's BadgerCare Plus group must incur medical bills equal to the deductible amount. Deductible-based eligibility is **not** extended to other children or members of the original assistance group. The parents' medical expenses may be used for meeting the deductible of more than one child at a time.

Under *non-MAGI* rules, to meet the deductible, the child or other family members included in the BadgerCare Plus group must incur medical bills equal to the deductible amount. Once the deductible is met, the child and all other children under 19 in the BadgerCare Plus group will be covered under the Standard plan without a premium, for the remainder of the deductible period.

17.3.1 Deductible Period

The child under 19 can choose to begin the BadgerCare Plus deductible period as early as three months prior to the month of application and as late as the month of *application*.

Example 1: On November 1, 2014 John's mother and step-father apply for BadgerCare Plus for themselves, John and John's two step-brothers. The family's countable income is above 150% FPL. John's mother has employer sponsored insurance that covers her and John. John is ineligible for BadgerCare Plus due to the insurance access. John's step-brothers are eligible for BadgerCare Plus with a premium. Because the health insurance does not cover all of John's medical expenses, in December John's mother requests a deductible for John. The deductible period is December through May. John has medical bills that will meet the deductible as of January 1st. John will be covered under the standard plan with no premium from January through May.

The BadgerCare Plus deductible period for a child can include a month in which, if he or she had applied, he or she would have been ineligible for a non-financial reason other than health insurance access or coverage. Although excess income is still calculated over a six month period, the child can only be certified for BadgerCare Plus during the dates when he or she met all non-financial criteria other than health insurance access or coverage.

A new deductible period can be established at any time before the current deductible has been met.

17.3.2 Calculating the Deductible Amount

To calculate the dollar amount of the BadgerCare Plus deductible for children under age 19 under *non-MAGI* rules.

1. Determine the BadgerCare Plus deductible period.
2. Find the BadgerCare Plus group's total countable income for each month in the deductible period.
3. Compare the total income of each month with 150% FPL. If a month's income is less than or equal to 150% FPL, ignore it. If a month's income is more than the income limit (150% FPL), find the excess income by subtracting the income limit from the income of that month. The child could choose to drop the deductible for months his or her income decreases and the child is eligible to enroll in BadgerCare Plus. If the child chooses to drop the deductible, the 6-month deductible period is interrupted and the deductible lapses. If the income later increases to above 150%, the child would need to start a new deductible period.
4. Add together the excess income of the months in the deductible period. The result is the child's BadgerCare Plus deductible amount.

To calculate the dollar amount of the BadgerCare Plus deductible for a child under *MAGI* rules:

1. Determine the BadgerCare Plus deductible period.
2. Find the child's assistance group's total countable income for each month in the deductible period.
3. If the assistance group's total countable income includes the income of someone other than the child, the child's parents, or, if married, the child's spouse, subtract the income of that person, but do not change the group size of the AG.
4. Compare the total income of each month with 150% FPL. If a month's income is less than or equal to 150% FPL, ignore it. If a month's income is more than the income limit (150% FPL), find the excess income by subtracting the income limit from the income of that month. The child could choose to drop the deductible for months his or her income decreases so that the child is eligible to enroll in BadgerCare Plus.
5. Add together the excess income of the months in the deductible period. The result is the child's BadgerCare Plus deductible amount.

Example 1: John, age 14, is ineligible for BadgerCare Plus because his assistance group's income is over 150% of the FPL and he is covered under his mother's

employer sponsored health insurance plan. The household's size is 5. Their income is \$3466.25 per month, which is \$366.25 over the 150% FPL for a group size of 5. John's six month deductible amount is \$2197.50. ($366.25 \times 6 = 2197.50$)

Example 2: Mark, age 5, is ineligible for BadgerCare Plus because his assistance group's income is over 306% of the FPL. The household is made up of Mark's mother, who earns \$4,000/month and his brother, age 17, who earns \$1,500/month and whose income is counted because he is expected to be required to file taxes. Mark's assistance group's income is \$5,500 per month, which is \$3,026 over the 150% FPL for a group size of 3. However, because Mark's brother is not his parent or spouse, we must exclude his income from the deductible calculation. This reduces the excess income to \$1,526. John's six month deductible amount is \$9,156 ($\$1,526 \times 6 = \$9,156$).

his page last updated in Release Number: 14-02

Release Date: 05/14/14

Effective Date: 04/01/14

[View History](#)

17.4 MEETING THE DEDUCTIBLE

The BadgerCare Plus member or group meets the *deductible* by incurring medical or remedial costs that equal the dollar amount of the deductible. The countable costs are added together. When they are equal to or greater than the amount of the deductible, the pregnant woman or child under 19 can be certified for BadgerCare Plus through the end of the deductible period.

Note: Under *MAGI* rules, the deductible is built on an individual basis. To meet the deductible, the member and his or her parents in the BadgerCare Plus group must incur medical bills equal to the deductible amount. The parent's medical expenses may be used for meeting the deductible of more than one child at a time, but deductible-based eligibility is not extended to other children or members of the original assistance group.

If an expense was applied to a prior deductible but did not result in BadgerCare Plus certification, it can be applied to a later deductible, as long as it still meets the criteria listed in ([17.4.1](#)).

17.4.1 When Expenses Can Be Counted Toward a Deductible

To be counted toward the deductible, a medical or remedial expense must meet all of the following conditions.

1. Be incurred by a member of the child's or pregnant woman's BadgerCare Plus group.

Expenses may also be counted if incurred for someone the pregnant woman is legally responsible for if that individual could be counted in the member's BadgerCare Plus group. The medical bill may be used even if the family member is no longer living or no longer in the current BadgerCare Plus group.

Example 1: Sally's minor child Ida died of leukemia in April. In September, Sally requests that a medical bill incurred for Ida be used towards her deductible. Sally is still legally responsible for the bill. The bill can be used to meet the deductible as long as it did not result in a BadgerCare Plus certification in an earlier period.

2. Meet the Definition of Medical or Remedial expense described in [17.4.2](#).
3. Meet one of the following four conditions:
 - a. Still be owed to the medical service provider sometime during the current deductible period.

Expenses which have been "deferred" by the provider are considered a countable cost still owed to the provider and can be used to meet a BadgerCare Plus deductible.

- The deferred charge should be viewed as an incurred expense that remains an unpaid obligation for the member.
- If only a portion of the deferred charge was used to meet a prior deductible, any remaining balance can be used to meet future deductibles.
- Because many deferred charge situations involve very high costs for the services provided, it is extremely important to document in Case Comments which portion of the deferred charges are used to meet previous deductibles, and any remaining balance that can be used to meet current or future deductibles.

Example 2: In May, Helen resided in an Institute for Mental Disease ([IMD](#)) and incurred a \$14,000 bill. In October, Helen becomes pregnant and applies for BadgerCare Plus.

Helen turned in the bill for the stay in the IMD which shows the amount as 'deferred charges' which means the member would never be billed for the charges, but if he or she happens to come into a windfall of money (lottery or inheritance), they will change the status of those charges to current and try to collect the debt.

Helen can use this "deferred" charge toward her deductible.

Example 3: Lestat's parent applies for BadgerCare Plus in July 2008. A BadgerCare Plus deductible of \$700 is calculated for him. In January 2003, he had a blood transfusion. The bill for the transfusion was \$800. The bill was never paid. Lestat can use the unpaid bill to meet his BadgerCare Plus deductible, but must provide documentation to show that the charges are currently owed. The remaining \$100 can be applied to the next deductible period, as long as it is still owed.

- b. Paid or written off sometime during the current deductible period. Medical bills written off through bankruptcy proceedings are not allowed as a medical expense to meet a deductible.

Example 4: Estelle applies for BadgerCare Plus in March. A deductible period is set up for March through August. In April, she had a two-year-old medical bill of \$300 written off. She can apply the \$300 toward the March - August deductible because it was written off during the deductible period.

- c. Paid or written off sometime during the deductible period that immediately precedes and borders on the current deductible period. These bills can be used even if they were paid after the person met the deductible in the prior period.

Example 5: Jeffrey is in his second deductible period. He did not meet his deductible in the prior period, which borders on the current period. He has a bill that was written off in the prior period. He can apply this bill to his current deductible.

Example 6: Malcolm is in his second deductible period which began March 1, 2007. He did not meet his deductible in the prior deductible period, which immediately preceded the current deductible period. He has a medical bill that he paid in February 2006. He may not apply this toward his current deductible.

Example 7: Norah is in her second deductible period which began in September. In June, Norah met her deductible and was certified for BadgerCare Plus. After certification, and before the prior deductible period ended in August, Norah paid for medical services that were not BadgerCare Plus covered services. Norah can apply these paid bills to the deductible period that began in September.

- d. Paid or written off some time during the three months prior to the date of [application](#). This expense can only be used for the first deductible period. Balances cannot be carried forward to future deductible periods.

Example 8: Julie applies for BadgerCare Plus in August. Her deductible for the period from August through January is \$1500. On May 10th she paid off a \$2000

outstanding medical bill. She can use that expense to meet her deductible because it was paid in the three months prior to the date of her application. The remaining \$500 cannot be applied to future deductible periods.

17.4.2 Countable Expenses

1. **Medical expenses.** Medical expenses are costs for services or goods that have been prescribed or provided by a professional medical practitioner (licensed in Wisconsin or another state) regardless of whether the services or goods are covered by BadgerCare Plus. Medical expenses for services or prescriptions acquired outside of the U.S. may be counted toward a deductible if a licensed medical practitioner or pharmacy provided the service or drug.

Some examples of medical expenses are deductibles, co-payments and premiums for BadgerCare Plus, Medicare, private health insurance; and bills for medical services which are not covered by the Wisconsin BadgerCare Plus program.

Note: MMIS data may be used to calculate BadgerCare Plus co-payments from the previous deductible period.

2. **Remedial expenses.** Remedial expenses are costs for services or goods that are provided for the purpose of relieving, remedying or reducing a medical or health condition. Some examples of remedial expenses are:

- a. Case management.
- b. Day care.
- c. Housing modifications for accessibility.
- d. Respite care.
- e. Supportive home care.

Supportive Home Care is necessary assistance to help people meet their daily living needs, ensure adequate functioning in their home, and safely access their community. Services may include:

- Assistance with activities of daily living
- Attendant care
- Supervision
- Reporting changes in the member's condition,
- Assistance with medication and medical procedures which are normally self-administered, or

- The extension of therapy services, ambulation and exercise.
 - Tasks associated with routine household upkeep, including general housekeeping chores, lawn mowing, snow removal, changing storm or screen windows and other household services that are essential to the member's safety, well being and care at home.
- f. Transportation.
- g. Community Based Residential Facility (CBRF), Adult Family/Foster Home (AFH), Residential Care Apartment Complex (RCAC), and all other community substitute care setting program costs not including room and board expenses.

Remedial expenses do not include housing or room and board expenses.

3. Ambulance service and other medical transportation including attendant services
4. Medical insurance premiums paid by a member of the BadgerCare Plus Group. These insurance premiums include disease specific and per diem hospital and nursing home insurance payments. Do not allow accidental insurance policy premiums as a countable cost.

Note: Unlike other expenses listed in this section that may not be applied toward a deductible until they are incurred, count medical insurance premiums from the first day of the deductible period, if the premium will be coming due anytime during the current deductible period.

5. Medical bills paid by a party who is not legally liable to pay them can be counted against a deductible...

Examples of parties that pay medical bills when not legally liable include, but are not limited to: Churches, fraternal organizations, Children's Special Health Needs Unit of the Division of Public Health, Veterans Administration and the AIDS Drug Assistance Program (ADAP).

6. The cost of medical services received at a Hill-Burton facility. The Hill-Burton Act was enacted by Congress to provide federal assistance for the construction and modernization of health care facilities. Medical facilities which receive Hill-Burton assistance must provide without charge a reasonable volume of services to persons unable to pay for those services.
7. In-kind payments. These are services or goods supplied to the provider in lieu of cash. Self declaration of the bill being satisfied is adequate verification.

8. Medical or remedial expenses that are paid or will be paid by a state, county, city or township administered program that meets the conditions detailed in # 1 through 7 above.

Examples include:

- General Assistance
- Community Options Program
- AIDS Drug Assistance Program (ADAP)

Example 1: Jenna receives a medical service which will be paid by ADAP. When Jenna becomes pregnant and applies for BadgerCare Plus she has a deductible to meet. This medical bill that has not been paid can be used immediately because it will be paid by the state administered ADAP program.

Example 2: Sally received a medical service in January which was paid by the state administered; state funded Community Options Program in the same month. In February Sally applies for BadgerCare Plus for herself and her son, James. Sally has access to health insurance so James must meet a deductible. Since the medical bill was paid by COP within three months of Sally's BadgerCare Plus application it can be used to meet James' BadgerCare Plus deductible.

9. Medical or remedial expenses that have been paid or will be paid by Indian Health Services that meet the conditions detailed in [\(17.4.2\)](#).

Example 3: On January 1, Michael received a medical service which will be paid by Indian Health Services. When Michael applies for BadgerCare Plus on January 10 he has to meet a deductible. The bill for the January 1 medical services may be used immediately because it will be paid by the Indian Health Services program.

Example 4: Charlie received a medical service in January which was paid by Indian Health Services in the same month. In February Charlie's mother applies for BadgerCare Plus. Charlie has to meet a deductible. Since the bill was paid by Indian Health Services within three months of Charlie's BadgerCare Plus application, it can be used to meet Charlie's BadgerCare Plus deductible.

17.4.3 Expenses That Cannot Be Counted Toward a Deductible

Do not count the following toward the deductible:

1. Medical bills written off through bankruptcy.
2. Medical services payable or paid for by a third party who is legally liable for the bill. This includes bills that will be paid or have been paid by BadgerCare Plus, Medicare or other Insurance.

Example 1: The costs of medical services provided to an incarcerated person are not allowed as expenses to meet a deductible. The incarcerating authority is the legally liable third party.

3. A bill cannot be used if it has been used to meet a prior deductible. If only a portion of an unpaid bill was used to meet a prior deductible, any remaining balance that was not applied to the prior deductible, may be applied to a subsequent deductible period as long as it is still owed or meets criteria in [\(17.4.1\)](#).

*this page last updated in Release Number: 14-02
Release Date: 05/14/14
Effective Date: 04/01/14*

[View History](#)

17.5 ORDER OF BILL DEDUCTION

When applying medical bills to the *deductible*, start with the earliest service date. If more than one bill has the same service date, use the bill with the highest amount first, then the next highest and so on down to the lowest bill with that same service date.

17.5.1 Hospital Bills

Hospitals do not always itemize the cost of their services according to the day and time of day the patient received the services. It is sometimes difficult to know when the patient met the deductible.

For this reason, if the patient's hospital bill for one continuous stay in the hospital is equal to or above the deductible amount on the date of admission, the first day of admission is the date of service for the entire bill. The hospital bill is applied to the deductible first before counting any other medical costs that were incurred during the hospital stay.

Example: Linda submits a \$2,000 bill toward her deductible, for hospitalization from July 12th through July 14th. She also submits a physician bill for \$2,500 with a date of service of July 12th. Apply the \$2,000 hospital bill to the deductible first.

17.5.2 Pregnancy Fees

Many providers charge a flat fee for pregnancy related services. The single-fee includes all prenatal care, office visits, delivery, and postnatal care.

The entire "global" pregnancy fee is counted as an expense as of the date an agreement was signed.

*This page last updated in Release Number: 07-01
Release Date: 10/29/07
Effective Date: 02/01/08*

[View History](#)

17.6 PREPAYING A DEDUCTIBLE

[17.6.1 Insufficient Funds](#)

[17.6.2 Payment of Entire Deductible Amount](#)

[17.6.3 Combination of Payment and Incurred Expenses](#)

[17.6.4 Combination of Payment and Outstanding Expenses](#)

[17.6.5 Calculation Errors](#)

Anyone can prepay a BadgerCare Plus *deductible* for him or herself or for someone else. It can be paid in installments or all at once. A prepaid deductible may be refunded if the member requests a refund of the prepayment prior to the begin date of the corresponding deductible period.

Instruct the member to make the payment payable to the local Income Maintenance Agency. Report the receipt on the Community Aids Reporting System (CARS) on Line 909.

With the payment, include:

1. Documentation that the payment is voluntary.
2. The member's name and BadgerCare Plus ID number.

17.6.1 Insufficient Funds

If the deductible is paid with a check that is returned for insufficient funds, discontinue the person's eligibility, determine if an overpayment occurred and if so, establish a claim for benefit recovery.

17.6.2 Payment of Entire Deductible Amount

If the entire deductible amount is paid at any point during the deductible period, eligibility begins on the first date of the deductible period.

Example: Laura's deductible period is from March 1st through August 31st. The total deductible amount is \$1,000. Laura submits payment of \$1,000 on August

15th. Laura's BadgerCare Plus eligibility begins on March 1st.

17.6.3 Combination of Payment and Incurred Expenses

If the deductible is met through a combination of payment and incurred medical expenses, count the incurred medical expenses first. Eligibility, by paying the remaining deductible amount, can begin no earlier than the last date of incurred medical expense within the deductible period.

Example: Gloria's deductible period is from March 1st through August 31st. The total BadgerCare Plus deductible amount is \$1,800. Gloria submits a medical bill with a March 8th date of service for \$800. On July 15th, she submits payment of \$1,000. Gloria's BadgerCare Plus eligibility begins March 8th. A BadgerCare Plus Remaining Deductible Update ([F-10109](#)) must be submitted to identify the provider of service on March 8th and the \$800 member share amount.

17.6.4 Combination of Payment and Outstanding Expenses

If the deductible is met through a combination of payment and outstanding medical expenses (incurred prior to the beginning of the deductible period), eligibility begins on the first date of the deductible period.

Example: Roberta's deductible period is from March 1st through August 31st. The total BadgerCare Plus deductible amount is \$1,500. She submits an outstanding bill from January 10th for \$500. On August 15th, she submits payment of \$1,000. Roberta's BadgerCare Plus eligibility begins March 1st

Enter the first date of the deductible period on AGTM as the date the payment was received.

17.6.5 Calculation Errors

If any portion of the deductible is paid and you find the amount was wrong due to agency error, refund the paid amount that was incorrect and report the refund on CARS. If the error was caused by an *applicant* /member error, see ([28.2](#)) for determining the overpayment amount.

*This page last updated in Release Number: 07-01
Release Date: 10/29/07
Effective Date: 02/01/08*

[View History](#)

17.7 REMAINING DEDUCTIBLE

When the member receives a medical bill that is equal to or greater than the amount he or she still owes on the *deductible*, he or she can be certified for BadgerCare Plus.

However, he or she is still responsible for the part of the bill that equals the deductible. BadgerCare Plus will consider the remainder of the bill for payment. See (Process Help [Chapter 19 Deductibles](#)).

A BadgerCare Plus Remaining Deductible Update ([F-10109](#)) must be sent to the fiscal agency indicating the amount of the bill that the member owes. The *Fiscal Agent* subtracts this amount from the bill and BadgerCare Plus pays the rest.

Fill out the BadgerCare Plus Remaining Deductible Update ([F-10109](#)) only if:

1. A BadgerCare Plus certified provider has provided the billed services.
2. The person, having met the deductible, is being certified. If he or she is not being certified, BadgerCare Plus will not pay any of the bill.

The date of the bill is the date the deductible was met. Since the member is not eligible until he or she has met the deductible, he or she still owes for all bills prior to that date.

*This page last updated in Release Number: 07-01
Release Date: 10/29/07
Effective Date: 02/01/08*

[View History](#)

17.8 CHANGES IN INCOME

Once the *deductible* has been met, changes in income do not affect the group's eligibility for the remainder of the deductible period.

If there are income changes reported during the BadgerCare Plus deductible period but prior to meeting the deductible, recalculate the BadgerCare Plus deductible amount.

1. Add together the monthly excess income of the months of the BadgerCare Plus deductible period that have already gone by.
2. Using prospective net income, find the excess income of the months in the deductible period after the month when income changed.
3. Add the results of #1, #2 and #3.

Example 1: Cicely, a pregnant woman with income over 300% FPL, applied for BadgerCare Plus in July. She had excess income of \$20 a month. Her BadgerCare Plus deductible was \$120. On October 8th, she reports a pay increase of \$10 a month. The change is effective for November. The BadgerCare Plus deductible amount is recalculated by:

1. Adding together the excess income of months July through October. The result is \$80.
2. Calculating her November excess income. The result is excess income of \$30.
3. Prospective excess income for December is \$30.
4. Cicely's new BadgerCare Plus deductible amount is: $\$80 + \$30 + \$30 = \140 .

If the income change results in lower excess income in the month of change, the *applicant* can choose to:

1. Recalculate the current BadgerCare Plus deductible, or
2. Create a new deductible period.

Example 2: Mary, a pregnant woman, goes from full time to part time employment in the fourth month of her BadgerCare Plus deductible period. She still has excess income, but it is lower than in the previous three months. She can choose either to recalculate her BadgerCare Plus deductible to a lower amount or to start a new deductible period.

If she chooses to start a new deductible period, she will forfeit any eligibility she might have acquired in the previous deductible period if she had met the previous deductible.

If the income change results in no excess income the applicant has an additional choice:

1. Recalculate the deductible.
2. Create a new deductible period.
3. Begin eligibility immediately.

17.9 NON-FINANCIAL CHANGES

[17.9.1 Non-Financial Changes Introduction](#)

[17.9.2 Group Size Changes](#)

[17.9.3 Death](#)

17.9.1 Non-Financial Changes Introduction

If there is a change in non-financial eligibility during the *deductible* period, discontinue BadgerCare Plus eligibility for those persons who have become non-financially ineligible.

If a child enters the BadgerCare Plus group after the deductible for another child in the group has been met, that child will also be eligible for the remainder of the deductible period.

If an adult caretaker relative who is EBD, or is medically verified as pregnant, enters the BadgerCare Plus group, his or her name will appear on the BadgerCare Plus card for the remainder of the deductible period.

If a member loses non-financial eligibility and regains it during the same deductible period, the member may choose:

- To continue with the current deductible period.
- OR**
- To reapply and establish a new deductible period if his or her income still exceeds the appropriate BadgerCare Plus income limit.

17.9.2 Group Size Changes

When the group size is different on the last day of the month from what it was on the last day of the previous month, and the deductible is not met, you must recalculate the deductible. Compare the new group's countable monthly income with the new group's FPL limit. If there is excess monthly income, recalculate the deductible in the same way as for income changes.

17.9.3 Death

If the member dies during the deductible period, and is not already certified, look at all countable expenses prior to death. If those countable expenses meet the deductible,

certify the person. The time period for the deductible remains six months. All months that remain of the six-month deductible period from the point the member dies, are considered to have \$0 income. The deductible amount should be recalculated. If the deductible was met, eligibility will be the point from which eligibility was determined to have been met through the date of death.

If the member prepays the deductible and dies after the deductible period starts, the deductible is non-refundable. If the member prepays and dies before the deductible period starts, the deductible pre-payment is refundable.

*this page last updated in Release Number: 13-02
Release Date: 10/25/13
Effective Date: 10/01/13*

[View History](#)

17.10 LATE REPORTS OF CHANGES

If the member turns in late reports on income changes or medical costs, recalculate the *deductible* as of the date the change took place or the medical cost was incurred. See what would have been the deductible had he or she reported the changes and the medical costs as they occurred. If the medical bills would have met the deductible for any past date, begin BadgerCare Plus certification on that date.

*This page last updated in Release Number: 07-01
Release Date: 10/29/07
Effective Date: 02/01/08*

18 BC+ Extensions

[View History](#)

18.1 BADGERCARE PLUS EXTENSIONS

[18.1.1 BadgerCare Plus Extensions Introduction](#)

[18.1.2 Pregnant Women](#)

[18.1.3 Children](#)

18.1.1 BadgerCare Plus Extensions Introduction

18.1 BadgerCare Plus Extensions

A BadgerCare Plus Extension is a period of eligibility given to a person when the assistance group's income increases above 100% FPL either due to an increase in earned income, child support income, and/or spousal support; and otherwise meets the BadgerCare Plus eligibility criteria for persons with incomes below 100% FPL.

- *Non-MAGI* BadgerCare Plus individuals (parents/caretakers, pregnant women, and children) can enter an extension when the assistance group's earned income, child support, or both increases above 100% FPL.
- A parent/caretaker relative or pregnant woman whose eligibility is determined using *MAGI* rules can enter an Extension due to an increase above 100% FPL in the assistance group's earned income, spousal support, or both. The children, stepchildren, and NLRR children of the parent/caretaker will also enter the Extension at this time, provided they are under age 19, living with the parent/caretakers, and meet the income requirements outlined in section [18.1.3](#).

BadgerCare Plus members eligible as childless adults are not eligible for an Extension.

If a family is also moving out of the State of Wisconsin at the time of the income increase, or if a case closes for lack of review or verification and then later reappplies, they would not be eligible for the Extension. While on the Extension, the member is covered under the Standard Plan and is not subject to the insurance access and coverage requirements. For example, having access to employer health insurance when the family income increases from 80% to 175% FPL will not make them ineligible for the Extension.

Non-exempt adults are subject to premiums while in an Extension (see [19.1](#)) with the exception of adults whose income is at or below 133% FPL during the first 6 calendar months of their Extension. Starting April 1, 2014, the restrictive re-enrollment period for adults who fail to pay a premium will be 3 months (See [19.11](#)). For RRP's that being prior to April 1, 2014, if the adult member has served at least 3 months in an RRP, the RRP may be ended.

Former Foster Care Youth under *non-MAGI* rules are eligible for a BadgerCare Plus Extension when they have a natural or adoptive child in the household and that child meets the criteria for an Extension. If the FFCY is tested under *MAGI* rules, the FFCY will no longer qualify for Extensions.

The BadgerCare Plus Extension lasts 4 months when the income goes above 100% FPL solely due to an increase in child support or spousal support. Child support Extensions can occur for anyone under non-MAGI rules. Because child support is not a counted income type under MAGI rules, such Extensions for members tested under MAGI rules can only occur based on an increase in spousal support.

Note: Extensions will not be granted to anyone in the household if the household fails to verify the income that would trigger the extension unless all the parents/caretakers in the Extension are exempt from paying premiums because they are disabled, a tribal member or pregnant.

18.1.2 Pregnant Women

A pregnant woman tested under *non-MAGI* rules who is not a parent or caretaker relative of a child during her pregnancy, can only become eligible for an Extension if she was enrolled in BadgerCare Plus, with income at or below 100% of the FPL, for 3 months once her pregnancy reaches the 8th month. Look back 60 days from her due date or the date the pregnancy ended to determine the 8th month. If she was a parent or *caretaker relative* and enrolled with income at or below 100% FPL in 3 of the past 6 months she would be eligible for an Extension.

Example 1: June, a single woman with no children under her care, was pregnant with a due date of September 8th. She applied for and was enrolled in BadgerCare Plus effective March 1st. Her income was below 100% of the FPL for the entire time she was enrolled. She gave birth on September 8th and reported the birth and her marriage to the father of the baby to her worker. His income put the countable household income over 100% of the FPL. Since the eighth month of her pregnancy was July (September 8th minus 60 days), she was enrolled in BadgerCare Plus with income less than 100% for three months (July, August and September), beginning with the 8th month of her pregnancy. She is eligible for a 12 month BadgerCare Plus Extension.

Example 2: Judith and her 2 children have been enrolled in BadgerCare Plus with income below 100% FPL since January. In March, she reported that she was pregnant with a due date of October 5th. On August 10th, Judith reported she received a raise which caused her countable household income to exceed 100% FPL. Since she was enrolled with income at or below 100% FPL for 3 out of the past 6 months, she and her children are eligible for an Extension. Since Judith is eligible as a pregnant woman, she will retain that status in the Standard Plan with no premium until the end of the month 60 days after the pregnancy ends. At that time she will be put into the Extension with her children.

Beginning January 1, 2014, a pregnant woman whose eligibility is tested under MAGI rules will be able to enter an Extension if she was eligible for BadgerCare Plus as a pregnant woman or a parent or caretaker relative at any time during the pregnancy with income at or below 100% FPL in 3 of the past 6 months. In most cases, her continuous eligibility as a pregnant woman will take precedence over the Extension, but the Extension will be maintained and will result in eligibility if the pregnancy and postpartum period end prior to the end of the Extension.

18.1.3 Children

Under *non-MAGI* rules, Extensions apply to all the parents and children in the home who are eligible as part of the same BadgerCare Plus Test Group ([2.3.1](#)). When the Test Group's income exceeds 100% FPL due to increased earnings or child support, all members of the affected BadgerCare Plus group go into the Extension, as long as at least one member of the group was eligible with income below 100% FPL for 3 of the

18.1 BadgerCare Plus Extensions

previous 6 months. Likewise, under most circumstances, the end of an Extension will apply to all of the members of the BadgerCare Plus Test group. For example, when the household income decreases to 100% FPL or less, the Extension will end for both parents and children. Only when an Extension ends for a parent for failure to pay a required premium will we continue the Extension for the child.

All dependent children, stepchildren and *NLRR* children who are eligible under MAGI rules and whose parent or caretaker becomes eligible for an Extension under MAGI rules will be eligible for the same Extension provided that they are eligible for BadgerCare Plus in the month prior to the start of the Extension and:

- Have AG income under 306% FPL and are under age 1
 - Have AG income under 191% FPL and are age 1 through age 5
 - Have AG income under 156% FPL and are age 6 through age 18

Conditions:

1. Children do not have to be eligible for BadgerCare Plus for 3 of the past 6 months.
2. The child's AG income does not have to be below 100% FPL at the time the Extension starts.
3. CENs are not eligible for Extensions.
4. A child who is currently in an Extension is not eligible for a new extension.
5. If a parent's income decreases below 100% FPL the child's extension continues.
6. Once a child is in an Extension, the child does not lose the extension for any reason except for death, moving out of Wisconsin, or turning 19 while in an earned income Extension.

Note: If a child is in an unexpired Extension and a parent qualifies for a new Extension, the child's Extension will continue to stay in the original Extension eligibility category until it expires. The child is not eligible for the new Extension.

*this page last updated in Release Number: 14-02
Release Date: 05/14/14
Effective Date: 04/01/14*

[View History](#)

18.2 INCREASE IN EARNINGS/DECREASE IN GROUP SIZE EXTENSIONS

[18.2.1 Earned Income Extensions Under Non-MAGI Rules](#)

[18.2.2 Earned Income Extensions under MAGI Rules](#)

[18.3 Supplemental Security Income Exception](#)

18.2.1 Earned Income Extensions under Non-MAGI Rules

To receive a BadgerCare Plus Extension due to an increase in earnings, a person whose eligibility is determined under *non-MAGI* rules must meet all of the following requirements:

1. The income increase that caused the countable income to exceed 100 percent *FPL* must be due solely to one of the following:
 - a. Increased earnings
 - b. Increased earnings along with other income (changed or unchanged)
 - c. A decrease in group size
2. He or she must be a BadgerCare Plus member with income at or below 100 percent FPL at the time the income increased to over 100 percent FPL. This also applies to a decrease in group size.
3. The parent, caretaker, or pregnant woman must have been enrolled in BadgerCare Plus with income that was at or below 100 percent FPL for at least three of the six months immediately preceding the month in which the income went above 100 percent FPL.
4. He or she must otherwise meet the BadgerCare Plus eligibility criteria for persons with income below 100 percent FPL.
5. He or she verified his or her income unless he or she is exempt from paying a premium.

Example 1: Mary and her two children had been enrolled in BadgerCare Plus with income below 100 percent FPL since January. Her husband Denny moved back into the house in June. When Denny was added to the case with his additional earned income, the group's countable income went over 100 percent FPL. Because Mary and the two children were enrolled in BadgerCare Plus with income below 100 percent FPL for three of the prior six months at the time the income went above 100 percent, they are eligible for a 12-month BadgerCare Plus Extension. Denny is not included in the Extension because he was not enrolled in BadgerCare Plus at the time the income increased.

18.2.2 Earned Income Extensions under MAGI Rules

To receive a BadgerCare Plus Extension due to an increase in earnings, a parent, caretaker, or pregnant woman under *MAGI* rules must meet all of the following requirements:

18.2 Increase in Earnings/Decrease in Group Size Extensions

1. The income increase which caused the countable income for his or her BadgerCare Plus **AG** to exceed 100 percent FPL must be due solely to one of the following:
 - a. Increased earnings (of anyone in the same AG)
 - b. Increased earnings along with other income (changed or unchanged)
2. He or she must be a BadgerCare Plus member with income at or below 100 percent FPL at the time the income increased to over 100 percent FPL.
3. The parent, caretaker, or pregnant woman must have been enrolled in BadgerCare Plus with income that was at or below 100 percent FPL for at least three of the six months immediately preceding the month in which the income went above 100 percent FPL.
4. He or she must otherwise meet the BadgerCare Plus eligibility criteria for persons with income below 100 percent FPL.
5. He or she verified his or her income unless he or she is exempt from paying a premium because he or she and any co-parent or spouse in the AG are disabled, a tribal member, or pregnant. (This policy applies to all adults in the AG. Unless they are all exempt from paying a premium, income must be verified.)

Note: These requirements do not apply to children eligible under MAGI rules (see [Section 18.1.3 Children](#)).

Example 2: Jane lives with her two teenage children and Dave, the non-marital co-parent of the two children. Jane is claiming both children on her taxes and her income for her MAGA AG of three is 90 percent FPL. Dave's MAGA AG consists only of himself, and he is eligible for BadgerCare Plus with income of 95 percent FPL. The children-in-common are eligible in a MAGC AG group of four, with both parents as counted adults in their AG and their group's income is 121 percent FPL. Jane was enrolled in BadgerCare Plus with income below 100 percent FPL for three of the prior six months. In June, her earned income increased to 120 percent FPL. She is eligible for a 12-month BadgerCare Plus Extension. Dave is not included in the Extension because he was not a counted member of Jane's AG. The children are eligible for a 12-month Extension because they were eligible in June when Jane's income rose above 100 percent and their own AG's income was below 156 percent FPL at the time.

18.2.3 Supplemental Security Income Exception

A person who was eligible for **SSI** benefits may be eligible for a BadgerCare Plus Extension if he or she loses SSI and would have been eligible for BadgerCare Plus with countable income at or below 100 percent if he or she had not been an SSI recipient.

Example 3: Mary is receiving SSI. Her two children are enrolled in BadgerCare Plus with countable income at or below 100 percent FPL. Mary started a job and her earnings put her above the SSI income limit. Her earned income also caused

the BadgerCare Plus countable income to exceed 100 percent FPL. Both Mary and her two children are eligible for a 12-month BadgerCare Plus Extension.

This page last updated in Release Number: 15-02

Release Date: 09/02/2015

Effective Date: 09/02/2015

[View History](#)

18.3 INCREASE IN CHILD SUPPORT OR SPOUSAL INCOME EXTENSIONS

[18.3.1 Support Extensions Under Non-MAGI Rules](#)

[18.3.1.1 Four Month Extension under Non-MAGI Rules](#)

[18.3.1.2 Twelve Month Extension under Non-MAGI Rules](#)

[18.3.2 Support Extensions Under MAGI Rules](#)

[18.3.2.1 Four Month Extensions under MAGI Rules](#)

[18.3.2.2 Twelve Month Extensions under MAGI Rules](#)

18.3.1 Support Extensions under Non-MAGI Rules

For assistance groups (AG) under non-MAGI rules, if a BadgerCare Plus member's countable income increases above 100% FPL and all or part of the excess income consists of child support income, grant an Extension of either 4 or 12 months depending on the case circumstances.

18.3.1.1 Four Month Extensions under Non-MAGI Rules

The 4 month Extension applies only if:

1. The income increase which caused the countable income to exceed 100% FPL must be due solely to:
 - a. Increased child support income or,
 - b. Increased child support income along with other unearned income (changed or unchanged).
2. There has been no increase in earned income.
3. He or she must be a BadgerCare Plus member with income at or below 100% FPL, at the time the income increased to over 100% FPL.

18.3 Increase in Child Support or spousal Income Extensions

4. At least 1 member of the AG must have been enrolled in BadgerCare Plus with income that was at or below 100% FPL for at least 3 of the 6 months immediately preceding the month in which the income went above 100% FPL.
5. He or she must otherwise meet the BadgerCare Plus eligibility criteria for persons with income below 100% FPL, and
6. He or she verified his or her income, unless he or she is exempt from paying a premium.

18.3.1.2 Twelve Month Extensions under Non-MAGI Rules

The 12 month BadgerCare Plus Extension applies only if:

1. Earned income increased but child support income remained the same or both earned income and child support income increased.
2. He or she is a BadgerCare Plus member with income at or below 100% FPL, at the time the income increased to over 100% FPL.
3. At least 1 member of the AG has been enrolled in BadgerCare Plus with income that was at or below 100% FPL for at least 3 of the 6 months immediately preceding the month in which the income went above 100% FPL, and
4. He or she otherwise meets the BadgerCare Plus eligibility criteria for persons with income below 100% FPL.
5. He or she verified his or her income, unless he or she is exempt from paying a premium.

18.3.2 Support Extensions under MAGI Rules

For AGs using *MAGI* rules, if a parent, caretaker, or pregnant woman's countable income increases above 100% FPL and all or part of the excess income consists of spousal support income, grant an Extension of either 4 months or 12 months depending on the case circumstances.

18.3.2.1 Four Month Extensions under MAGI Rules

The 4 month Extension only applies if:

1. The income increase which caused the countable income to exceed 100% FPL must be due solely to:
 - a. Increased spousal support income, or
 - b. Increased spousal support income along with other unearned income (changed or unchanged).
2. There has been no increase in earned income.

3. He or she is an eligible BadgerCare Plus member with income at or below 100% FPL, at the time the income increased to over 100% FPL.
4. He or she must have been enrolled in BadgerCare Plus with income that was at or below 100% FPL for at least 3 of the 6 months immediately preceding the month in which the income went above 100% FPL.
5. He or she otherwise meets the BadgerCare Plus eligibility criteria for persons with income below 100% FPL
6. He or she verified his or her income, unless he or she is exempt from paying a premium.

18.3.2.2 Twelve Month Extensions under MAGI Rules

The 12 month BadgerCare Plus Extension applies only if:

1. Earned income increased but child support income remained the same or both earned income and child support income increased.
2. He or she is a BadgerCare Plus member with income at or below 100% FPL, at the time the income increased to over 100% FPL.
3. He or she must have been enrolled in BadgerCare Plus with income that was at or below 100% FPL for at least 3 of the 6 months immediately preceding the month in which the income went above 100% FPL, and
4. He or she otherwise meets the BadgerCare Plus eligibility criteria for persons with income below 100% FPL.
5. He or she verified his or her income, unless he or she is exempt from paying a premium.

*this page last updated in Release Number: 14-02
Release Date: 05/13/14
Effective Date: 04/01/14*

[View History](#)

18.4 INCOME CHANGES DURING THE EXTENSION

During an Extension, a group or individual's income may decrease to an amount at or below 100% FPL for the group size and then increase again to exceed the 100% FPL. When the income decreases, the individual will be removed from the Extension and placed in regular BadgerCare Plus. The remaining months of the Extension will continue to run in the background. If the individual's countable income again increases above the 100% FPL, he or she would be eligible under the previous Extension for any remaining months. If the individual is eligible for a new Extension when the income again increases, because he or she meets all of the criteria above, choose the Extension which gives the longest coverage, and cancel the other.

Example 1: A BadgerCare Plus group with a 12-month Extension from January through December has a decrease in income in February that puts them back below 100% FPL. The Extension continues to run while the group is on regular BadgerCare Plus. In October the group's countable income again increases to above 100% FPL, this time due to an increase in Child Support income. They are now eligible for a four-month child support Extension which would run from November through February. Since the four month Extension would be longer than the current extension, apply the new four-month Extension.

*This page last updated in Release Number: 07-01
Release Date: 10/29/07
Effective Date: 02/01/08*

[View History](#)

18.5 LOSING AN EXTENSION

[18.5.1 Introduction](#)

[18.5.2 Leaving Wisconsin](#)

18.5.1 Introduction

A BadgerCare Plus member loses an Extension if one or more of following happens:

1. He or she fails to cooperate in providing third party health insurance coverage ([TPL](#)). Children under 19 are exempt from any penalty for not cooperating with this requirement.
2. All children under the parent's or caretaker relative's care have either left the household or turned 19 and the Extension was based on an increase in earned income.
3. A child in an earned income Extension turns 19.
4. He or she fails to provide verification of income and at least one parent/caretaker in the extension AG is not disabled, a tribal member, or pregnant. Only the non-disabled, non-tribal, non-pregnant parents/caretakers are ineligible for failure to provide verification. The other members of the family in the extension remain eligible for the duration of the Extension.
5. He or she fails to pay a premium or quits BadgerCare Plus (See [19.11](#)). Only the parents/caretakers that owed the premium (those in the BCPM AG) are put into a restrictive re-enrollment period. The other members of the family in the Extension remain eligible for the duration of the Extension.

Note: Under *MAGI* rules, children in a support Extension who turn 19 do not lose the extension just for turning 19. Similarly a parent or caretaker relative in a support

Extension just because all of the children under his or her care either left the home or turned 19.

Note: An assistance group does not need to maintain employment in order to maintain an earned income Extension, irrespective of whether the assistance group is tested under *MAGI* or *non-MAGI* rules.

If a condition necessary for an Extension is lost, the Extension is not regained solely by recovering the lost condition.

Example 1: A group has an Extension and the parent fails to provide verification of earnings. The parent loses eligibility for BadgerCare Plus. The children in the Extension remain eligible for the duration of the Extension. The parent does not regain the Extension if she later provides verification of income.

18.5.2 Leaving Wisconsin

If a BadgerCare Plus member is eligible for an Extension and moves out of Wisconsin, he or she loses the Extension. He or she can regain the Extension if he or she returns and becomes a Wisconsin resident again during any month in the original Extension period.

Example 3: Earl, a Wisconsin resident, received a 12-month Extension beginning January 1, 2008. He moved out of state, thus losing his Extension. On May 1, 2008, he moved back to Wisconsin and became a Wisconsin resident again. He regained the Extension at the time he moved back to Wisconsin and became a Wisconsin resident.

If the time period of the Extension expires while the person is out of state, he or she does not regain the Extension.

Example 4: Gloria, a Wisconsin resident received a 12-month Extension beginning January 1, 2008. She moved out of state, thus losing her Extension. In February 2009, she moved back to Wisconsin and became a Wisconsin resident again. She does not regain the Extension because the time period has expired.

*this page last updated in Release Number: 14-02
Release Date: 05/14/14
Effective Date: 04/01/14*

19 Premiums

[View History](#)

19.1 BADGERCARE PLUS PREMIUMS

Note: Premium policies for BadgerCare Plus Core members are found in the archived PDF version of Chapter 43.

The following individuals must pay a premium to become or remain eligible for BadgerCare Plus unless exempt:

1. Children in families with income over 200% FPL (under non-MAGI rules) or 201% (under MAGI rules),
2. Parents, stepparents and caretaker relatives with income over 100% FPL in a BadgerCare Plus Extension that starts on or after April 1, 2014,
3. Through March 31, 2014, parents, stepparents and caretaker relatives with income over 133% through 200% of the FPL,
4. Through March 31, 2014, self-employed parents, stepparents and caretaker relatives with income above 200% of the FPL before subtracting the depreciation but below 200% of the FPL after subtracting the depreciation.

Note: Effective with BadgerCare Plus Extensions that begin on or after April 1, 2014, parents, stepparents and caretaker relatives with income between 100% and 133% FPL in a BadgerCare Plus Extension will be subject to premiums starting in the seventh calendar month of their Extension. October 2014 is the first month for which premiums will be charged for non-exempt adults in an Extension with income at or below 133% FPL.

If a member's income changes during their Extension, he or she will only be exempt from premiums if he or she is in the first six calendar months of that Extension, and if his or her income is at or below 133% FPL.

- If the member has an increase in income that puts his or her income above 133% FPL, he or she will be subject to premiums, even if he or she is still in the first six calendar months of the Extension.
- If the member's income subsequently decreases to below 133% FPL, he or she will be exempt from premiums as long as he or she is in the first six months of the Extension.
- If the member's income drops below 100% FPL, he or she will be enrolled in regular BadgerCare Plus and is no longer subject to a premium.
- If the member's income drops below 100% FPL, then later increases and the member qualifies for a new Extension, a new six-month premium exemption will begin with the new Extension.
- If the member's income drops below 100% FPL, then later increases and the member does not qualify for a new Extension, the member will be re-enrolled in the previous Extension and the original six-month time frame for exempting premiums will apply.

Example 1: Jane starts a 12-month Extension in June, when her income increases from 90% FPL to 110% FPL. If Jane's income remains below 133% FPL, she will owe a premium beginning in December, the seventh month of her Extension.

Example 2: Jane starts a 12-month Extension in June, when her income increases from 90% FPL to 110% FPL. On August 5th, she reports she received a raise, and her income goes up to 155% FPL. Jane owes a premium starting in September. If her income stays above 133% FPL through November, she will continue to owe a premium, even though she is in the first six months of her Extension. She will owe a premium, irrespective of whether her income is above or below 133% FPL, for December through May.

Example 3: Joe starts a 12-month Extension in May, when his income increases from 90% FPL to 110% FPL. On June 3rd, he reports he received a raise, and his income goes up to 155% FPL. In July, he will owe a premium. In August, he reports a reduction in hours, bringing his income down to 120% FPL starting in the month of August. He will not owe a premium in August, September or October, but starting with the month of November, his six-month exemption is over, so he will start paying premiums again.

Example 4: Jim starts a 12-month Extension in August, when his income increases from 90% FPL to 140% FPL. He owes a premium. He reports a reduction in hours effective December, which brings his income down to 120% FPL. He will not owe a premium in December or January, but starting in February, his six-month exemption is over, so he will start paying premiums again.

The following individuals are exempt from the requirement to pay a premium:

1. All pregnant women and pregnant minors,
2. Pregnant women under age 19 with income at or below 300% of the FPL,
3. Former Foster Care Youth. ([Chapter 11](#)),
4. Children who have met a BadgerCare Plus *deductible*, during the remainder of the deductible period,
5. Children in a BadgerCare Plus Extension,
6. Children who are not in an Extension but whose parents are in an Extension and paying a premium,
7. Adult parents and caretakers who are blind or disabled or MAPP Disabled, as determined by the Disability Determination Bureau (DDB) or through the presumptive disability process ([MEH, 5.9](#)),
8. Adults with assistance group income at or below 100% FPL,
9. All children under age 1 including Continuously Eligible Newborns ([Chapter 8.2](#)),
10. American Indian or Alaskan Native Tribal members, the son or daughter of a tribal member, the grandson or granddaughter of a tribal member, or anyone otherwise eligible to receive Indian Health Services.

Note: Persons who are members of families receiving BadgerCare Plus benefits, but who are individually certified for EBD Medicaid, Well Woman Care, Family Planning Only Services or Emergency Services, are not charged a BadgerCare Plus premium.

this page last updated in Release Number: 14-03

Release Date: 09/05/14

Effective Date: 09/05/14

[View History](#)

19.2 Premium Calculations

[19.2.1 Premium Calculations for Non-MAGI Households](#)

[19.2.2 Premium Calculations Effective January 1, 2014](#)

[19.2.2.1 Children's Premiums Using MAGI Rules](#)

[19.2.2.3 Adults' Premiums Using MAGI Rules](#)

19.2.1 Premium Calculations for Non-MAGI Households

Note: The following policy applies to all BadgerCare Plus members whose eligibility is determined under non-MAGI rules.

Under BadgerCare Plus, premiums for children are initially calculated on an individual basis and then a total for the case is determined. Premiums for adults are based on a percentage of the household income and the amount is the same regardless of the number of adults covered by the premium **CARES** will calculate the premium for each case. The general rules for calculating the premium amounts are as follows:

1. The minimum monthly premium amount for children is \$10 per person.
2. For children with a family income above 300% of the FPL, the individual premium shall not exceed the full per member per month cost of coverage for a child.
3. For non-pregnant, non-disabled parents and caretaker relatives, including those in BadgerCare Plus Extensions with a family income above 133% of the FPL, premiums will be calculated based on a sliding scale, ranging from 3% of countable household income for individuals above 133% of the FPL to 9.5% of household countable income for individuals at or above 300% of the FPL. Premiums for adults will be calculated based on actual household income and rounded to the nearest dollar. See [48.1](#) for premium ranges based on family size and income.

4. Through March 31, 2014, for self-employed parents, stepparents and caretaker relatives, with incomes above 200% of the FPL before subtracting the depreciation but below 200% of the FPL after subtracting the depreciation, the caretaker relative's share of the premium shall be 5% of the family's net income, before subtracting depreciation from the self-employment income.
5. Through March 31, 2014, for families with income over 300% of the FPL, if at least one member of the case is eligible for BadgerCare Plus as a self-employed adult or as a grandfathered individual, the combined total of all family members' premiums will be either the total of all children's premiums, or 5% of the family's income, whichever amount is greater. One exception is for families that include a child living with a caretaker relative. If the only BadgerCare Plus eligible members are children under 19, the 5% cap does not apply and the family owes the per member per month premiums for the children.
6. Through March 31, 2014, for families with income below 300% of the FPL, where only children owe a premium or self-employed parents/caretakers owe the 5% premiums, the combined total of all family members' premiums will be rounded down to the nearest whole dollar amount.
7. Through March 31, 2014, For families with income at or above 300% of the FPL, premium amounts for cases where only children owe a premium and the 5% premiums for self-employed parents/caretakers will not be rounded.
8. For pregnant women under age 19 with income over 300% of the FPL, the individual premium shall not exceed the full per member per month cost of coverage for a child with a family income of 300% of the FPL.

Pregnant women may sometimes fall into one of the other premium groups. In those cases, the following rules apply:

1. Pregnant minors with income between 200% and 300% of the FPL are not charged a premium.
2. Pregnant minors with income over 300% of the FPL are charged the child's premium rate.
3. Pregnant parents, stepparents or caretaker relatives with income between 133% and 200% of the FPL are not charged a premium.
4. Pregnant self-employed parents, stepparents or caretaker relatives with income between 200% and 300 % of the FPL are not charged a premium.
5. Pregnant parents, stepparents or caretaker relatives with self-employment income above 300% FPL are not charged a premium and do not have to meet a deductible.

The premium for the BadgerCare Plus group is the total of the individually calculated premiums for the children included in the group. For example, a household with three children and family income between 200% and 210% of the FPL will owe \$30, or \$10 per eligible child in the family.

Premiums for adults with household income less than or equal to 200% of FPL or in an extension are based on a percentage of the household income and the amount is the same regardless of the number of adults covered by the premium.

19.2.2 Premium Calculations for MAGI Households

The basic approach for determining premiums remains the same for MAGI households: premiums for children are initially calculated on an individual basis and then a total for the case is determined, while premiums for adults in Extensions are based on a percentage of the adult's assistance group income. However, there are some significant differences to premium amount calculations under MAGI rules. CARES will calculate the premium for each case, but the general rules for calculating the premium amounts are explained below for children and adults.

19.2.2.1 Children's Premiums using MAGI Rules

1. The minimum monthly premium amount for children is \$10 per person.
2. The maximum monthly premium for a child with income above 301% up to 306% FPL is \$97.53.
3. Each child's premium amount will be based on their AG's size and income. Under MAGI rules, it is possible for different children within the same household to have different amounts of income counted and to have a different AG sizes. For this reason, each child's AG is evaluated separately to determine that AG's income and group size, which is the basis for determining the FPL percentage of that child's income. That FPL percentage, in turn, will determine whether a child potentially owes a premium and the amount of the premium.
4. The premium for the BadgerCare Plus group is the total of the individually calculated premiums combined, not to exceed 5% cap.
 5. The cap will be 5% of the income of the assistance group with the highest income (in terms of dollar amount) in the case. (See [19.3.](#))

19.2.2.2 Adults' Premiums using MAGI Rules

1. For non-pregnant, non-disabled parents and caretaker relatives in BadgerCare Plus Extensions with a family income above 133% of the FPL, premiums will be calculated based on a sliding scale, ranging from 3% of countable income for individuals above 133% of the FPL to 9.5% of countable income for individuals at or above 300% of the FPL.
2. Premiums for adults in extensions will be calculated based on actual income and rounded to the nearest dollar. See [48.1](#) for premium ranges based on family size

and income. When a child is pulled into an adult's extension, the child does not owe a premium.

3. Adults in an extension who are married filing jointly, or who are married but not filing taxes, will have a combined premium. Adults in an extension who are married filing separately or are non-marital co-parents will have premiums calculated on an individual basis.

Note: Pregnant minors are not charged a premium.

this page last updated in Release Number: 13-02

Release Date: 10/25/13

Effective Date: 10/01/13

[View History](#)

19.3 Premium Limits

For all BadgerCare Plus members whose eligibility is determined under non-MAGI rules, families with incomes at or below 300% of the FPL will never have to pay in excess of 5% of the family income for their total premiums.

The 5% caps will be calculated for income ranges of 10% of the FPL. For example, the 5% cap would be the same for a family with income at 211% of the FPL as it would be for a family with an income at 218% of the FPL.

Exceptions to this policy are:

1. Children living with caretaker relatives exception: Unlike children living with their parents, eligibility for children living with caretaker relatives is determined separately from their caretaker relatives and from other children living with the caretaker relative. The amount of their premium is based solely on their income. The 5% cap on the child living with a caretaker relative premium is calculated separately from the caps on the premiums for other children living with caretaker relative in the household and from the cap on the premium for the caretaker relative and the caretaker relative's immediate family.
2. Exception for children and self-employed parents with incomes over 300% of the FPL: Usually the 5% premium owed for self-employed parents will not exceed the amount of the per member per month (PMPM) cost of the children's premiums. However, some larger families with more than five children will have PMPM costs greater than 5% of the family's income. For those families, collect the full PMPM per cost for those children even though it exceeds the 5% limit. For those families, no additional premium amount will be owed for the self-

employed parents.

3. Adults with incomes over 180% of the FPL in a BadgerCare Plus Extension.
4. Adults with incomes over 180% of the FPL up to 200% of the FPL.

For all BadgerCare Plus members whose eligibility is determined under MAGI rules, children with assistance group income above 201.00% of the FPL will be required to pay premiums. The total premium amount for the household is the total of the individually calculated premiums, not to exceed a 5% cap. The cap will be 5% of the income of the assistance group with the highest income (in terms of dollar amount) in the case.)

The 5% cap methodology for children with premiums will be effective as soon as one child on the case who is subject to premiums has his or her eligibility determined using MAGI rules.

Example: Susan and Alan are non-marital co-parents caring for four children: Susan's son, Aaron (15); Alan's daughters Rachel (12) and Hannah (11); and Susan and Alan's son Jacob (9). Alan claims Rachel and Hannah as his two tax dependents, while Susan claims Aaron and Jacob. Susan earns \$2500/month as a waitress, and Alan earns \$4500/month as a computer analyst. None of the children have income. All four children are eligible for BadgerCare Plus.

Child	MAGI Group Formation	AG Income Amount	FPL	Premium Amount
Aaron	Susan, Aaron, and Jacob	\$2500	122%	\$0
Rachel	Alan, Rachel, and Hannah	\$4500	276%	\$55
Hannah	Alan, Rachel, and Hannah	\$4500	276%	\$55
Jacob	Susan, Alan, Aaron, Rachel, Hannah, and Jacob	\$7000	265%	\$44

Aaron does not have a premium, Rachel and Hannah have \$55 premiums, and Jacob has a premium of \$44. In this example, 5% of the income of the assistance group with the highest income is 5% of Jacob's MAGI group, or 5% of \$7000/month, or \$350. Altogether, the household's monthly premiums are \$154. The household will pay \$154 in premiums for their children's coverage.

Parents and caretakers in Extensions will pay premiums based on the sliding scale discussed above, without a 5% cap applied. Non-exempt children with incomes above 201% of the FPL will not be required to pay premiums when the adults in the household are paying premiums in an Extension. If the parents enter a restrictive re-enrollment period (RRP) for failure to pay a premium or are otherwise ineligible, non-exempt children with income above 201% will be required to pay a premium.

*this page last updated in Release Number: 14-01
Release Date: 02/07/14
Effective Date: 02/01/14*

[View History](#)

19.4 Premium Payment Methods

Upon request from the member, the *fiscal agent* (1-888-907-4455) will provide members with instructions for choosing their preferred payment method from the list below.

Approved payment methods include:

1. Direct payment by check or money order.
2. Electronic Funds Transfer (EFT).
3. Wage withholding from each paycheck received.

Agencies are responsible to provide members with the Wage Withholding ([F-13025](#)) and EFT ([F-13026](#)) forms upon request, to facilitate the choice of payment method other than direct payment. Instruct the member to mail the completed forms to the address listed on the forms once he or she has chosen a payment method. Direct premium payments must be made until the fiscal agent informs the family the EFT and wage withholding has been set up.

*This page last updated in Release Number: 07-01
Release Date: 10/29/07
Effective Date: 02/01/08*

[View History](#)

19.5 INITIAL PAYMENTS

Payment of the BadgerCare Plus premium is a non-financial condition of eligibility. Initial premium payments must be made before eligibility is confirmed and the members are enrolled. The first month is free if no one in the BadgerCare Plus group was eligible for BadgerCare Plus or Medicaid in the previous month, and the BadgerCare Plus AG has not received a free month in the previous 12 months. Consider someone with an unmet *deductible* as not being eligible for BadgerCare Plus.

The Income Maintenance agency is responsible for collecting the initial payments and recording the payment in *CWW*. Acceptable payment types include: check (personal, cashiers, travelers,

etc.) or a money order. Check must be issued to BadgerCare Plus.

A BadgerCare Plus Premium Information/Payment form ([F-10139](#)) must be sent to the *fiscal agent* along with the payment. The BadgerCare Plus AG *CARES* case number must be included on the form ([F-10139](#)) and on the check. The BadgerCare Plus Premium Information/Payment form ([F-10139](#)) can be found at <http://dhs.wisconsin.gov/forms/F1/F10139.pdf> or go to the CARES mainframe manual standard letter CNSL NCBP009901. Mail the initial BadgerCare Plus premium payment (check or money order) and completed form directly to the BadgerCare Plus lockbox at:

BadgerCare Plus
c/o Wisconsin Department of Health Services
Box 93187
Milwaukee, WI 53293-0187

The eligibility policy and time frame procedures for premium payments are as follows:

1. Initial eligibility date and confirmation occur in the month of [application](#).

When an application is processed in the same month it was received, and a premium for the initial month of eligibility is not due because they are eligible for a free month, the premium for the second month of eligibility must be paid in advance before a family can be enrolled in BadgerCare Plus.

Example 1: Lisa and her family applied for BadgerCare Plus on January 25th. On January 31st, the worker determined that the family met eligibility requirements effective January 1st. Since the family had not been previously eligible for BadgerCare Plus, a premium for January was not assessed since they were eligible for the free month. However, Lisa had to pay the February premium for her family before their eligibility could be confirmed.

2. Eligibility begins in the month of application - confirmation occurs in a future month.

When an application is not processed within the 30-day application processing period and the family is eligible for a free month, the family must pay both the second and third months' premium before enrollment. CARES requires that premiums for both the second and third months be paid before confirmation when eligibility is processed any time in the third month.

Example 2: Cheryl and her family applied for BadgerCare Plus on March 25th. No one in

her family was eligible for BadgerCare Plus in the previous month. At Cheryl's request, the IM worker extended the 30-day processing time period by ten days for additional verification. The application for BadgerCare Plus was processed on May 2nd, but the family was determined eligible effective March 1st. A premium is not due for March because it is a free month. However, Cheryl had to pay the premium amount for April and May before BadgerCare Plus eligibility could be confirmed.

3. Eligibility begins in a future month, but application is processed in the month of application.

When an application is processed within 30 days but eligibility does not begin until a future month, the free month is the first future month of eligibility. The family will receive an invoice for the premium amount through the mail. He or she must pay the premium due for the second month by the tenth of the benefit month to remain eligible for BadgerCare Plus.

Example: Arnie and his family applied for BadgerCare Plus on April 12th. He and his family were determined to be eligible for BadgerCare Plus beginning May 1st. A premium is not assessed for May. A coupon for Arnie's June premium was mailed on May 20th with payment due by June 10th.

*This page last updated in Release Number: 13-01
Release Date: 02/28/2013
Effective Date: 02/28/2013*

[View History](#)

19.6 On-going Payment

BadgerCare Plus premiums are due on the tenth of the benefit month, regardless of which payment method is chosen.

1. For families who have chosen "direct pay" as their payment method, the [fiscal agent](#) sends out the BadgerCare Plus premium coupons on the 20th of the month before the benefit month.
2. Electronic funds transfer occurs on the third business day of the benefit month.

*This page last updated in Release Number: 07-01
Release Date: 10/29/07
Effective Date: 02/01/08*

[View History](#)

19.7 Advance Payments

Through December 31, 2013, payments can be made in advance (further than the next month), but the payment cannot exceed the current *certification period*.

If paying in advance, the payments must be the full amount of subsequent month's premiums (no partial month payments). If the income amount changes, the premium amount will be recalculated and the member will be notified through *CARES* that his or her premium amount has changed. If the premium amount has decreased, the *fiscal agent* will refund any excess premium that was paid. If the premium amount has increased and the premium coupon has not been sent for that month, the member will receive a coupon with the new premium amount. If the premium coupons have already been sent, the member will need to pay the additional amount owed. The member will not receive a coupon for the difference that is owed.

Effective January 1, 2014, premium payments can no longer be made in advance.

19.7.1 Refunds

Contact the BadgerCare Plus Unit at 1-888-907-4455 to issue a refund if the premium was paid in advance and the premium is for a month in which the:

1. Individual/family was ineligible for BadgerCare Plus.
2. The group's countable income decreased and they no longer owe a premium, if the income change was reported timely.
3. A lower premium amount is due to a change in circumstances which was in effect for the entire month as long as the change was reported within ten days of the date it occurred. The lower premium amount due is the first day of the month in which the change was reported. A refund for the difference will be issued.

Example: A child without any income is added to the BadgerCare Plus group. Based on the group's income compared to the new group size, a premium is no longer owed. The fiscal agent will refund the premium that was paid in advance.

*this page last updated in Release Number: 13-02
Release Date: 10/25/13
Effective Date: 10/01/13*

[View History](#)

19.8 Non-Payment

[19.8.1 Non-Payment Introduction](#)

[19.8.2 Insufficient Funds](#)

[19.8.3 Good Cause for Non-Payment](#)

19.8.1 Non-Payment Introduction

The failure to pay a premium does not affect the eligibility of any person in the household who does not have a premium obligation. If an individual or family with a premium obligation fails to pay the premium by *adverse action* of the benefit month, BC + will close for those individuals who owed a premium.

- Children under age 19
 - Effective with RRPs beginning January 1, 2014 (for failure to pay December 2013 premiums), children under age 19 who do not pay their premiums will not be eligible for BadgerCare Plus for 3 calendar months, unless there is good cause (see [19.8.3](#)). See [19.11](#) for more information.
 - Through December 31, 2013, children were not eligible for 6 calendar months following the date on which their coverage terminated for failure to pay premiums, unless there was *good cause*. However, effective April 1, 2014, any RRPs that began prior to January 1, 2014 were updated in CARES to set the RRP end date to no later than 3 months after the RRP started.
- Adults age and older
 - Beginning April 1, 2014, adults who fail to pay a premium will not be eligible for BadgerCare Plus for 3 calendar months following the date on which their coverage terminated, unless there was good cause. See [19.11](#) for more information.
 - Through March 31, 2014, adults are not eligible for BadgerCare Plus for 12 calendar months following the date on which their coverage terminated, unless there was good cause. However, if the adult member has served at least 3 months in an RRP as of April 1, 2014, the RRP may be lifted and the member may re-enroll at their request.

For more information on how RRPs can be lifted and BadgerCare Plus eligibility reinstated, see [19.11](#).

The total family premium for a case must be paid to avoid being considered late or unpaid. No partial premium payments will be accepted.

19.8.2 Insufficient Funds

If a BadgerCare Plus member pays the monthly premium through EFT or direct payment by check, and the payment is rejected for insufficient funds it is considered a non-payment and the BadgerCare Plus eligibility will terminate. A restrictive re-enrollment (see [19.11](#)) will be applied unless there is good cause ([19.8.2](#)). The RRP

begins with the first month after closure. If an overpayment occurred, a benefit recovery claim should be established.

19.8.3 Good Cause for Non-Payment

Do not apply an RRP for non-payment if good cause exists. Good cause reasons for not paying the BC premium are:

1. Problems with the financial institution.
2. CARES problem.
3. Local agency problem.
4. Wage withholding problem.
5. Fair hearing decision.

The member must still pay the arrears before eligibility will begin again.

*his page last updated in Release Number: 14-02
Release Date: 05/14/14
Effective Date: 04/01/14*
[View History](#)

19.9 Late Payments

The case will remain open for the benefit month even if no payment is received by the due date. It will close at the end of the benefit month if no payment is received by *adverse action* in the benefit month.

If the member pays between adverse action of the benefit month and the last day of the benefit month, eligibility can be restored.

Example: Adverse action is September 16th. Jim's September premium was due September 10th. Jim has not paid his September premium by September 16th. He pays on September 26th. The case closed effective September 30th. Eligibility for October will be restored. He is not required to pay the October premium until October 10th.

Note: An individual's BadgerCare Plus eligibility can be reinstated during an RRP if the individual pays the owed premiums. For information about payments made during the RRP, see [19.11](#).

his page last updated in Release Number: 14-02
Release Date: 05/14/14
Effective Date: 04/01/14

[View History](#)

19.10 Premium Changes

[19.10.1 Decreased premium amount](#)

[19.10.2 Increased premium amount](#)

[19.10.2.1 Person adds](#)

[19.10.2.2 Effective dates of premium increase \(Person Add\)](#)

[19.10.2.3 Effective dates of premium increase \(other than person adds\)](#)

19.10.1 Decreased premium amount

When a change is reported that results in a lower premium amount, it is effective during the month in which the change occurred or the month in which it was reported, whichever is later. The *fiscal agent* will refund any excess premium that was paid.

19.10.2 Increased premium amount

You must give a 10-day notice to the member when the group is required to pay a premium for the first time or is required to pay a higher premium. The increase is effective the following month if BadgerCare Plus eligibility is confirmed before *adverse action*. If the change is confirmed after adverse action, the increase is not effective until the month after the following month.

Example 1: Jessica has BadgerCare Plus with a premium for her and her family. She reports a change in income to her worker on April 23rd that results in a higher premium amount. Jessica's premium amount will increase effective June 1st. She will receive the coupon for the new premium amount at the end of May.

19.10.2.1 Person adds:

If the person add will cause an increase in the premium, *CARES* will not allow eligibility confirmation if the notice requirement cannot be met. Certify eligibility for new members through the [ForwardHealth Portal](#). If unable to certify through the ForwardHealth Portal, complete and return the F-10110 (formerly DES 3070) for the days that cannot be confirmed in CARES. See [Process Help 81](#).

- Mail:

ForwardHealth iChange

P.O. Box 7636
 Madison, WI 53707-7636
 Fax: (608) 221-8815

- Fax: (608) 221-8815

19.10.2.2 Effective dates of premium increase (Person Add)

1. If the person was added to the case before adverse action, the increase is effective the next month.
2. If the person was added to the case after adverse action, the increase is not effective until the second month.

Example 2: Rachel's husband Mike moved back into the home on June 1st. She reported the change on June 6th and the agency processed the change on June 10th (before adverse action). Inclusion of Mike's income resulted in a premium increase. The increase is effective July 1st. Certify Mike's BadgerCare Plus eligibility effective June 6th by sending in a [F-10110](#) for the dates between June 6th and June 30th.

Example 3: Ann moved back to her parent's home on December 12th and reported it on the 22nd (after adverse action). The agency acted to process the change on the same day. Inclusion of Ann's income resulted in a premium increase. The premium increase is not effective until February 1st. Certify Ann's BadgerCare Plus eligibility effective December 22nd by submitting an [F-10110](#) for the dates between December 22nd and January 31st.

19.10.2.3 Effective dates of premium increase (other than person adds)

A delay in the effective date of premium increases must also be done in certain ongoing cases that may or may not include a person add. These are cases where a change results in an assistance group opening up and has new or increased premiums for a month (or months) that cannot be confirmed in CARES. In these situations, the member is not responsible for a premium payment (or a premium increase) for the month or months that cannot be confirmed in CARES. The first premium (or increased premium) for which the family must pay is the one for the month for which eligibility can be confirmed.

The following situations qualify for this treatment:

- **Through March 31, 2014,** a case reports a decrease in income from above 200% to below 200% FPL and the parents are now eligible with a premium.

- A person is added to a case that has not paid the premium for another member.
- A person becomes eligible for BadgerCare Plus for any non-financial reason except late payment of the previous month's premium, failure to verify a reported change that resulted in the premium increase, or failure to complete a renewal.
- Cases where the Call Center is unable to get premiums adjusted on the interChange system.
 - Effective **April 1, 2014**, a case reports a decrease in income from above 300% to below 300% and the child(ren) are now eligible with a premium.

In a situation where other members in the AG or in another BadgerCare Plus AG may owe a premium, treat their premium separately from the newly eligible members and/or AG. Through **March 31, 2014**, a family that owes a small premium for the children but then has an income decrease to below 200% of the Federal Poverty Level (FPL) that causes the parents to be eligible for a larger premium. With the income change, the children no longer owe a premium. If the premium was already paid for the children, that amount must be refunded. If the premium was not paid, the children should not be sanctioned for non-payment since they no longer owe a premium.

Example 4: June and Ward Cleaver are receiving BadgerCare Plus for their two sons, Wally and Theodore. The family income is 205% of the Federal Poverty Level (FPL), and they are paying \$20 in monthly premiums for the boys. On March 25, Ward reports a decrease in wages and the family's income is now 191% of the FPL. This makes June and Ward eligible for BadgerCare Plus with a premium. When the IM worker runs eligibility for May, the new BadgerCare Plus premium amount is \$213. CARES will not allow the worker to confirm eligibility for March or April because their premium is higher than the \$20 amount that had already been confirmed for the children. The worker needs to:

1. Confirm BadgerCare Plus eligibility in CARES for May,
2. Do an online or manual certification of BadgerCare Plus eligibility for Mr. and Mrs. Cleaver for the months of March and April. No premium is owed for the parents for those months, **and**
3. Issue a manual Positive Notice of Decision to the family for those two months.

In addition, since the sons are no longer required to pay a premium and are now eligible for the Standard Plan, the worker must also update their medical status code using the online or manual [F-10110](#). Once the medical status is updated in iC to a non-premium status, HP will automatically refund the \$20.00 premium that was paid.

Example 5: Mary and Tom apply for BadgerCare Plus on May 1, 2014 for their son, Sam, and Mary's daughter, Sara. Mary and Tom are not married and both plan to file taxes. Mary claims Sara as a dependent and Tom claims Sam. Sara's AG income is 208%, so she has a \$10 premium. Sam's AG income is at 310%, so he is not eligible for BadgerCare Plus. The case is confirmed on May 15, 2014 with Sara's eligibility beginning May 1, 2014. On June 1st, Tom

reports his income decreased in late March, resulting in Sam's AG income to decrease to 265%. Sam would now be eligible with a \$44 premium. Because CARES will not allow the worker to confirm the increase in premium for June, Sam will not be required to pay a premium until July 1, 2014, although he will be eligible as of June 1, 2014. Sara is still required to pay her \$10 June premium, and the combined premium of \$54 will be effective July 1, 2014.

*This page last updated in Release Number: 14-01
Release Date: 02/07/14
Effective Date: 02/01/14*

[View History](#)

19.11 BadgerCare Plus Restrictive Re-enrollment Period (RRP)

[19.11.1 Restrictive Re-Enrollment Period \(RRP\) Introduction](#)

[19.11.2 Reapplying](#)

19.11.1 Restrictive Re-Enrollment Period (RRP) Introduction

A member for whom a premium is owed for the current month who leaves BadgerCare Plus by not paying a premium may be subject to a restrictive re-enrollment period. A *restrictive re-enrollment period (RRP)* means the member cannot re-enroll in BadgerCare Plus for a certain number of months from the termination date while their income remains high enough to owe a premium, unless they pay the premiums owed, meet a good cause exemption or the RRP is lifted. Effective January 1, 2014, children can make late premium payments at any time during their 3 month RRP. Effective April 1, 2014, adults can make late premium payments at any time during their 3 month RRP.

Members must pay the overdue payment(s) that resulted in case closure, but do not have to pay the premium owed for the following month, unless the late payment is made after the benefit month.

Example 1: If a premium was owed for September, but is not paid until November, the premiums for September, October and November must be paid in order for eligibility to be restored for those months.

If the member owes a premium for a month during the RRP, he or she must pay all owed premiums before CARES will restore eligibility for BadgerCare Plus. The member must pay the IM agency directly (not the *Fiscal Agent*). You can check with the Fiscal Agent to see if a premium has already been collected for that month.

Example 2: Adverse action is September 16th. Jim has not paid his September

premium by September 16th. He finally pays on October 26th. His case closed on September 30th. Jim must pay both the premiums for September and October before eligibility can be restored. The November premium is not due until November 10th and does not have to be paid in advance.

Members whose income decreases to an amount that would not require a premium will be removed from the RRP and re-enrolled in BadgerCare Plus.

Children under age 19

- RRP's beginning on or after January 1, 2014, are set for 3 months.
- RRP's beginning prior to January 1, 2014, lasted for 6 months.
- However, any RRP's that began prior to January 1, 2014 were updated in CARES to set the RRP end date to March 31, 2014, as children are no longer required to be in a 6 month RRP.

Note: The RRP's impacted by the update to set the RRP end to March 31, 2014, are limited to RRP's that began in November 2013 or December 2013.

The child can become eligible for BadgerCare Plus again at any time during the three month RRP if he or she pays all owed premiums. The child's eligibility will be restored back to the beginning of the RRP. If the individual serves the full three month penalty period, he or she will become eligible for BadgerCare Plus again (without paying any owed premiums) on the first of the following month after the RRP ends, if he or she continues to meet the program eligibility criteria.

Example 3: Kayla (age 10) had a premium of \$10 and failed to pay her May premium. Her BadgerCare Plus benefits ended May 31 and she was put into a three month RRP from June 1 to August 31. Eligibility can be re-determined in September OR Kayla could re-enroll prior to September if she pays all owed premiums.

Effective April 1, 2014, any RRP's for children that began prior to January 1, 2014 were updated in CARES to set the RRP end date to no later than 3 months after the RRP started. If eligibility is subsequently re-run for an open case, the child's eligibility will re-open. However, if the case has been closed for more than 30 days, the household must reapply in order to regain BadgerCare Plus benefits for the child.

Adults age 19 and older

- RRP's beginning on or after April 1, 2014, are set for 3 months.
- RRP's beginning prior to April 1, 2014, lasted for 12 months. However, effective April 1, 2014, if the adult member has served at least three months in an RRP as of April 1, 2014, the RRP may be ended at the member's request.

An adult can become eligible for the remainder of the Extension again at any time during the three month RRP if he or she pays all owed premiums. The adult's eligibility will be restored back to the beginning of the RRP. If the individual serves the full three

month penalty period, he or she can become eligible for the remainder of the Extension (without paying any owed premiums) if he or she requests to re-enroll for the remainder of his or her Extension and if he or she continues to meet the program eligibility criteria.

After the RRP has been served, eligibility can be reinstated as of any month after the end of the RRP until the end of the Extension. For example, if an RRP ends June 30 for an Extension that runs through December, a member could request in November to be reinstated starting July 1. However, members must pay owed premiums for any months of coverage, and the months of eligibility must be consecutive. So using the same example, the member could not request to be reinstated for July, September, October and November, but not August.

Example 4: Joyce (age 29) is an adult in an Extension. She fails to pay the June premium, so she is in a 3 month RRP for July, August and September. In August, Joyce pays her owed premiums for June, July and August. Joyce's eligibility is restored back to the beginning of the RRP.

Example 5: Tina (age 45) did not pay the September premium while in an Extension. Tina will be in a 3 month RRP for October, November and December. Tina contacted the IM agency in January, after she served the full 3 month RRP and requested to re-enroll in BadgerCare Plus. As long as there are still months left in the Extension and she continues to meet the program eligibility criteria, Tina can re-enroll starting January without paying any owed premiums from the RRP. Tina would not be able to re-enroll for October, November and December. If Tina had contacted the agency in April, she would be able to choose whether to reinstate her enrollment starting in January, February or March, but she would not be able to choose to be covered only in February and then start coverage again in April.

Effective April 1, 2014, the 3 month RRP length will also apply to RRP's that started prior to April 1, 2014. If the adult member has served at least three months in an RRP as of April 1, 2014, the member can be re-enrolled in the remainder of the extension at his or her request.

Example 6: Chelsey fails to pay her October 2013 BCPA premium and is put in a 12 month RRP from November 1, 2013 to October 31, 2014. As of April 1, 2014, she has already served at least three months of her RRP. Chelsey contacts her IM agency to request that the RRP be ended and that she be reenrolled in BadgerCare Plus. The agency may reenroll Chelsey effective April 1.

One member in a household may be in an RRP while other members in the same household are still eligible for BadgerCare Plus or ineligible under a separate RRP. For example, children in the same household as a member on RRP may remain eligible for BadgerCare Plus if no premium obligation was owed for the children.

19.11.2 Reapplying

An individual who applies for BadgerCare Plus before the end of the RRP and whose assistance group's income is above the premium limit may be eligible for BadgerCare Plus for the remainder of the existing extension if he or she pays owed premiums. If the individual's assistance group's income is below the premium threshold, he or she can become eligible for BadgerCare Plus without paying owed premiums.

Example 7: Jackie, John and their three children are open for BadgerCare Plus. Jackie and John are in an Extension and have a premium. The children are eligible without a premium. They fail to pay the June premium so Jackie and John are in a RRP from July through September. The children are still eligible. In August, Jackie and John reapply for BadgerCare Plus and report a decrease in income to 95% FPL. Beginning August 1, Jackie and John are again eligible for BadgerCare Plus without a premium. In addition, because their income is below the premium threshold, they are not required to pay their owed premiums first.

*This page last updated in Release Number: 14-02
Release Date: 05/14/14
Effective Date: 04/01/14*

20 Assets

[View History](#)

20.1 ASSETS

There is no asset limit for BadgerCare Plus.

*This page last updated in Release Number: 07-01
Release Date: 10/29/07
Effective Date : 02/01/08*

21 - 24 Reserved

[View History](#)

CHAPTER 21-24 (RESERVED)

Chapter 21-24 (Reserved)

*This page last updated in Release Number: 07-01
Release Date: 10/29/07
Effective Date : 02/01/08*

PROGRAM ADMINISTRATION (CHAPTERS 25-37)

25 Application

[View History](#)

25.1 APPLICATION

Anyone has the right to apply for BadgerCare Plus; however, individuals under 18 years of age must have a parent or a legal guardian apply for BC + on his or her behalf unless he or she is living independently.

The *applicant* may be assisted by any person he or she chooses in completing an *application*.

Note: Individuals less than 18 years of age have the right to apply for BadgerCare Plus Family Planning Only Services on his or her own behalf.

Encourage anyone who expresses interest in applying to file an application as soon as possible. When an application is requested:

1. Suggest the applicant use the ACCESS online application at the following site <https://access.wisconsin.gov/access/> ; or
2. Mail the paper application form; or
3. Schedule a telephone or face-to-face interview.

Provide any information, instruction and/or materials needed to complete the application process. Provide a Notice of Assignment: Child Support, Family Support, Maintenance and Medical Support form ([DWSP-2477](#)) and *Good Cause* Claim form ([DWSP-2019](#)) to each applicant with children applying for BadgerCare Plus or to anyone that requests either of these.

Refer requests for applications and other outreach materials from groups and persons involved in outreach efforts to: <http://www.dhs.wisconsin.gov/em/customerhelp/>

Note: An application can be filed on behalf of a deceased person. If the application is filed within the same calendar month as the date of death or within the 3 months after the date of death, the application should be processed as if the applicant were alive. If the application is filed more than 4 months after the date of death, he or she is not eligible.

This page last updated in Release Number: 10-03

Release Date: 08/25/10

Effective Date : 08/25/10

[View History](#)

25.2 Application Types/Methods

BadgerCare Plus applicants have the choice of one of the following *application* methods:

1. ACCESS <https://access.wisconsin.gov/>.
2. Mail-In using the BadgerCare Plus Application Packet ([F-10182](#)).
3. Telephone Interview.
4. Face-to-Face Interview.
5. Use of the paper or online [application](#) available through the *Marketplace*
6. Telephone application with the *Marketplace*

This page last updated in Release Number: 13-02

Release Date: 10/25/13

Effective Date: 10/01/13

[View History](#)

25.3 Where to Apply

[25.3.1 Where to Apply Introduction](#)

[25.3.2 Intercounty Placements](#)

[25.3.3 Applications Outside Wisconsin](#)

[25.3.4 Applications Received from the Federal Marketplace](#)

25.3.1 Where to Apply Introduction

The *applicant* must apply in the county in which he or she [resides](#).

The agency (county/tribe or consortia) of the applicant's county of residence should process the individual's application.

The applicant's county of residence at the time of admission must receive and process applications for persons in these state institutions:

1. Northern, Central, and Southern Centers.
2. Winnebago and Mendota Mental Health Institutes.
3. The University of Wisconsin Hospital.

When an applicant contacts the wrong agency, redirect him or her to the consortium or tribal agency responsible for processing the *application* immediately. Anytime an application is received in the wrong consortium or tribal agency, it must be date stamped and redirected to the agency responsible for processing that application no later than the next business day. The *filing date* remains the date originally received by the wrong consortium or tribal agency.

25.3.2 Intercounty Placements

When a county 51.42 board, 51.437 board, human services department or social services department places a person in a congregate care facility that is located in another county, the placing county remains responsible for determining and reviewing the applicant's BadgerCare Plus eligibility. A congregate care facility is a:

1. Child care institution.
2. Group home.
3. Foster home.
4. Nursing home.
5. Adult Family Home (AFH).
6. Community Based Residential Facility (CBRF).
7. Any other like facility.

The placing county may request the assistance of the receiving county in completing applications for persons who are not enrolled in BadgerCare Plus and renewals for BadgerCare Plus members. The receiving county must then forward the information to the placing county. The placing county remains responsible for determining the applicant's eligibility. If the placing county requests assistance from the receiving county, the placing county must provide the other agency with:

1. The applicant's name, age, and [SSN](#) .
2. The date of placement.
3. The applicant's current BadgerCare Plus status.
4. The name and address of the congregate care facility in which the applicant has been placed.
5. The name of the county and agency making the placement.

When there is a dispute about responsibility, the social or human services department of the receiving county may initiate referral to the Department of Health Services' Area Administration office for resolution. Pending a decision, the county where the person is physically present must process the application, any changes and renewals.

25.3.3 Applications Outside Wisconsin

Generally, an application should not be taken for a resident of Wisconsin when he or she is living outside of Wisconsin. An exception is when a Wisconsin resident becomes

ill or injured outside of the state or is taken out of the state for medical treatment. In this case, the application may be taken, using Wisconsin's application forms ([25.1](#)), by the public welfare agency in the other state. The forms should be forwarded to the welfare agency in the other state. The Wisconsin IM agency determines eligibility when the forms are returned.

25.3.4 Applications Received from the Federal Marketplace

The Federally-facilitated *Marketplace* (the Marketplace or the Exchange) will begin sending applications to DHS through an account transfer process for individuals the Marketplace assesses as potentially eligible for BadgerCare Plus or Medicaid. Such applications are considered full applications for all "insurance affordability programs" including BadgerCare Plus and should be appropriately processed. The 30 day processing requirement begins on the day that the account is received by the local agency or the next business day if received after normal operating hours or on weekends or holidays. If eligible, the individual's benefits will begin on the first day of the month the application was filed at the Marketplace, not the date that the application was received by the agency. If the individual requests backdating, their eligibility will be backdated for up to three months from the first day of the month the application was filed at the Marketplace.

If a paper application from the Marketplace is mailed to a consortium or tribal agency, the IM worker should consider that application as an application for BadgerCare Plus and/or Medicaid and process it.

*this page last updated in Release Number: 13-02
Release Date: 10/25/13
Effective Date: 10/01/13*

[View History](#)

25.4 Valid Application

A valid *application* for BadgerCare Plus must include the applicant's:

1. Name, and
2. Address, **and** a
3. Signature in the Rights and Responsibilities section of one of the following forms:
 - Wisconsin Medicaid for the Elderly, Blind and Disabled Application / Review Packet ([F-10101](#)),
 - Medicaid, BadgerCare Plus and Family Planning Services Registration Application ([F-10129](#)),
 - BadgerCare Plus Application Packet ([F-10182](#)),

- BadgerCare Plus Supplement to FoodShare Wisconsin Application ([F-10138](#)) or an electronic signature in ACCESS,
- [Health Coverage & Help Paying Costs Application](#) from the Federally-facilitated *Marketplace*
- Telephonic signature in CARES
- Electronic signature in CARES
- Electronic signature in an account transfer from the Marketplace.

The date the BadgerCare Plus paper or ACCESS application received by the IM agency with the applicant's name, address and a valid signature ([25.5](#)) is the *filing date*. Applications must be processed within 30 days of the filing date. (See [25.7](#))

For applications assessed as Medicaid eligible that were filed at the Marketplace and subsequently determined eligible for BadgerCare Plus or the Medicaid, the filing date for the BadgerCare Plus or Medicaid coverage will be the date the application was submitted to the Marketplace. Marketplace-referred applications must be processed within 30 days of the date the Marketplace application was received by the consortium or agency. For additional information about the filing date, see [25.6](#).

*this page last updated in Release Number: 13-02
Release Date: 10/25/13
Effective Date: 10/01/13*
[View History](#)

25.5 Valid Signature

[25.5.1 Witnessing the Signature](#)

[25.5.2 Telephone Signature Requirements](#)

The *applicant* or the applicant's caretaker relative must sign (using his or her own signature):

1. The paper [application](#) form,
2. The signature page of the CAF (telephone or face to face) or
3. The ACCESS application form with an electronic signature.
4. The online or paper [Health Coverage & Help Paying Costs Application](#) from the Federally-facilitated Marketplace.

Except when:

1. A guardian signs for him or her. When an application is submitted with a signature of someone claiming to be the applicant's guardian, obtain a copy of the document that designates the signer of the application as the guardian. From the documents provided, ensure that the individual claiming to be the applicant's

guardian can file an application on his or her behalf. File the copy of the document in the case record.

Your agency's social services department determines the need for a guardian or *conservator* (IMM, Ch. I, Part A, 19.0.0). Determine the guardian type specified by the court.

Only the person designated as the guardian of the estate (IMM, Ch. I, Part A, 19.2.0), guardian of the person and the estate, or guardian in general may sign the application. You may not require a conservator (IMM, Ch. I, Part A, 19.4.0) or guardian of the person (IMM, Ch. I, Part A, 19.1.0) to sign the application.

2. An [authorized representative](#) signs for the applicant. The applicant may authorize someone to represent him or her (IMM, Ch. I, Part A, 18.3.0). An authorized representative must be an individual, not an organization.

If the applicant wishes to authorize someone to represent him or her when applying by mail, instruct him or her to complete the authorized representative section of the application form.

If the applicant needs to appoint an authorized representative when applying by telephone or in person, instruct the applicant to complete the Authorization of Representative form ([F-10126](#)).

An authorized representative is responsible for submitting the signed application (completed insofar as able) and any required documents.

When appointing an authorized representative, someone other than the authorized representative must witness the applicant's signature. If the applicant signs with a mark, two witness signatures are required.

When a Marketplace application is processed by the agency and an applicant has appointed an authorized representative in the application, the agency must honor this appointment of an authorized representative.

3. The applicant's durable power of attorney (§ 243.07, Wis. Stats.) signs the application. A durable power of attorney is a person to whom the applicant has given power of attorney authority and agrees that the authority will continue even if the applicant later becomes disabled or otherwise incapacitated.

When a submitted application is signed by someone claiming to be the applicant's durable power of attorney:

- a. Obtain a copy of the document the applicant used to designate the signer of the application as the durable power of attorney.

- b. Review the document for a reference that indicates the power of attorney authority continues notwithstanding any subsequent disability or incapacity of the applicant.

Do not consider the application properly signed unless both of these conditions are met. File a copy of the document in the case record. An individual's Durable Power of Attorney may appoint an authorized representative for purposes of making a BadgerCare Plus application, if authorized on the power of attorney form. The Durable Power of Attorney form will specify what authority is granted.

The appointment of a Durable Power of Attorney does not prevent an individual from filing his or her own application for BadgerCare Plus, nor does it prevent the individual from granting authority to someone else to apply for public assistance on his or her behalf.

4. Someone acting responsibly for the individual signs the form on behalf of the individual, if the individual is incompetent or incapacitated.

<p>Example: Carl is in a coma in the hospital. Sherry, a nurse who works at the hospital, can apply for BadgerCare Plus on Carl's behalf.</p>
--

5. A superintendent of a state mental health institution or center for the developmentally disabled signs on behalf of a patient.
6. A warden signs the application for an applicant that is an inmate of a state correctional institution that is out for more than 24 hours .
7. The director of a county social or human services department delegates, in writing (retain a copy of this written authorization), to the superintendent of the county psychiatric institution the authority to sign and witness an application for residents of the institution.

The social or human services director may end the delegation when there's reason to believe that the delegated authority is not being carried out properly.

25.5.1 Witnessing the Signature

The signatures of two witnesses are required when the application is signed with a mark.

An agency staff person is not required to witness the signature of a mail-in, online or telephone application.

Note: This does not affect the State of Wisconsin's ability to prosecute for fraud nor does it

prevent the BadgerCare Plus program from recovering benefits provided incorrectly due to an applicant or member's misstatement or omission of fact.

25.5.2 Telephone Signature Requirements

1. An audio recording of the following:
 - Key information provided by the household during the telephone interview;
 - Signature statement that includes:
 - i. Rights and responsibilities;
 - ii. Attestation to the accuracy and completeness of information provided;
 - iii. Attestation to the identity of individual signing the application;
 - iv. Release of information.
2. Store the audio recording in the electronic case file (ECF).
3. Send a written summary of the information provided during the interview. Include a cover letter that outlines the applicant or member's responsibility to review the information provided and notify the agency within ten calendar days if any errors are noted.
4. Store a copy of the written summary and cover letter in the electronic case file (ECF).

Note: Applications that are submitted through ACCESS or transferred from the Marketplace are signed electronically, so an additional signature (telephone or pen-and-paper) is not needed.

*this page last updated in Release Number: 13-02
Release Date: 10/25/13
Effective Date: 10/01/13*

[View History](#)

25.6 Filing Date

For health care applications submitted to a local agency, the *filing date* is the day a signed, valid *application* or registration form is delivered to the *IM* agency.

The filing date on an ACCESS application for health care is the date that the application is submitted electronically, regardless of the time of day it was submitted. The filing date on an application received from the *Marketplace* is the application date listed on the Marketplace application.

When an application is submitted by mail or fax, record the date that the IM agency received the valid application form or the next business day if the application is received after the agency's regularly scheduled business hours.

When a request for assistance is made by phone, the filing date is not set until a valid signature is received by the agency.

*This page last updated in Release Number: 16-01
Release Date: 02/15/2016
Effective Date: 02/15/2016*

[View History](#)

25.7 Timeframes

[25.7.1 Timeframes Introduction](#)

[25.7.2 Changes](#)

25.7.1 Timeframes Introduction

All applications received by an agency must be processed and eligibility approved or denied as soon as possible but no later than 30 calendar days from:

- The filing date for applications submitted directly to the local tribal or consortium agency,

OR

- The date the local agency received the application(s) from the Marketplace.

This includes issuing a notice of decision.

IM workers should not delay eligibility for an individual in a household when waiting for another household member's citizenship or identity verification. The individual pending for citizenship/identity should be counted as part of the group when determining eligibility for other group members. ([See 2.2](#))

Extend the 30-day processing time up to an additional 10 days, if you are waiting for the *applicant* to provide additional information. *CARES* will issue a pending notice indicating the reason for the delay when appropriate entries are made on the Verification Due Page.

Deny the *application* for failure to provide information or verification, if:

1. Requested information or verification is required by program policy to determine eligibility ([Chapter 9](#)), and
2. The applicant had the power to produce the information or verification, within the period, but failed to do so, and
3. The applicant had a minimum of 10 days to produce the verification.

Example 1: A signed application was received on March 15th. The worker processed the application on April 7th and requested verification. Verification was due April 17th, but was not received by that date. Even though the end of the 30-day application processing period was April 13th, the application should not have been denied until April 18th to allow at least 10 days to provide verification.

If the agency fails to take action (positive or negative) during the 30-day processing period, and the applicant is subsequently found eligible, determine eligibility using the original filing date.

Example 2: A signed application was received on May 15th. The first day of the 30-day period was May 16th. The end of the 30-day period would have been June 14th. The application was approved on June 20th, and the applicant is determined eligible beginning May 1st.

Example 3: A signed application was submitted to the Marketplace on March 2nd. The Marketplace assessed the individual as potentially eligible for BadgerCare Plus and transferred the individual's account to the agency on March 5th. The first day of the 30-day period for processing requirements was March 6th. The end of the 30-day period would have been April 4th. The application was approved on March 31st, and the applicant is determined eligible beginning March 1st.

25.7.2 Changes

Changes that occur between the filing date and the confirmation date should be used in the initial eligibility determination.

For changes that occur after the confirmation date, follow the adequate and timely notice requirements outlined in [IMM Chapter 1.2.2](#).

*this page last updated in Release Number: 14-01
Release Date: 02/07/14
Effective Date: 02/01/14*

[View History](#)

25.8 BEGIN DATES

[25.8.1 Backdated Eligibility](#)

[25.8.1.1 BadgerCare Plus Family Planning Only Services](#)

[25.8.1.2 Pregnant Women](#)

BadgerCare Plus eligibility begins the first day of the month in which the valid *application* is submitted and all eligibility requirements are met, with the following exceptions. Those begin dates are the date a valid application is submitted, all eligibility requirements are met, and:

1. *Deductible* - The date the deductible was met.
2. Inmates - The date the member is no longer an inmate of a public institution. See Section [3.6](#) for more information on exceptions.
3. Newborn - The date the child was born.
4. Person Adds - The date the person moved into the household.
5. BadgerCare Plus Prenatal Program - The first of the month in which a completed application is received and the pregnancy is verified.

Note: As of January 1, 2014, pregnancy for the BadgerCare Plus Prenatal Program will only be verified if the worker has information that contradicts the individual's self-declaration.

1. Recent Moves - The date the member moved to Wisconsin.
2. Insurance Coverage ends with *good cause* - The begin date for BadgerCare Plus is the date following the coverage end date.

25.8.1 Backdated Eligibility

All pregnant women, except those eligible under the BadgerCare Plus Prenatal program, may have their eligibility backdated to the first of the month, up to three calendar months prior to the month of application.

All former foster care youth that meet the criteria in [Chapter 11](#) may have their eligibility backdated to the first of the month, up to three calendar months prior to the month of application.

All disabled adults may have their eligibility backdated to the first of the month, up to three calendar months prior to the month of application.

Children determined eligible for BadgerCare Plus are eligible for the following periods of backdated eligibility:

- Infants less than 1 year old may have their eligibility backdated up to the first of the month, three calendar months prior to the month of application for any of the months in which their family income was at or below 300% FPL (under *non-MAGI* rules) **OR** at or below 306% FPL (under *MAGI* rules),
- Children ages 1 through 5 may have their eligibility backdated up to the first of the month, three calendar months prior to the month of application for any of the months in which their family income was at or below 185% FPL (under *non-MAGI* rules) **OR** at or below 191% FPL (under *MAGI* rules), and
- Children ages 6 through 18 may have their eligibility backdated up to the first of the month, three calendar months prior to the month of application for any of the months in which their family income was at or below 150% FPL prior to December 31, 2013 (under *non-MAGI* rules) **OR** at or below 156% FPL (under *MAGI* rules).

All non-pregnant, non-disabled parents and caretakers may have their eligibility backdated up to the first of the month, three calendar months prior to the month of application for any of the months in which their family income was:

- At or below 133% FPL, for new applications submitted prior to February 1, 2014
- OR**
- At or below 100% FPL, for new applications submitted after February 1, 2014.

Childless adults with assistance group income under 100% FPL will be eligible for backdating beginning in 2014. However, retroactive coverage cannot begin prior to April 1, 2014. As a result, a childless adult could not be eligible for the full three calendar months period of backdating until July 1, 2014.

If certifying for retroactive BadgerCare Plus, do not go back further than the first of the month, three months prior to the application month. Certify the person for any backdate month in which he or she would have been eligible had he or she applied in that month. In the case of children, certify the person for any backdate month in which he or she would have been eligible had he or she applied in that month and in which their assistance group income was at or below the appropriate FPL level for their age group.

A backdate request can be made at any time, except in the case where the member is already enrolled and backdating the member's eligibility would result in a deductible for the backdated period.

If a member has incurred a bill from a BadgerCare Plus certified provider during a backdate

period, instruct the member to contact the provider to inform them to bill BadgerCare Plus. The member may be eligible to receive a refund, up to the amount already paid to the provider.

Example 1: Mary who is pregnant with an August due date, applied for BadgerCare Plus on April 6th, and was found eligible. At the time of application, Mary did not request a backdate.

In September Mary is billed for a doctor's appointment she had at the end of February. Mary can ask to have her eligibility backdated through February. She meets all non-financial and financial eligibility criteria in the months of February and March. Her worker certifies her for BadgerCare Plus for both months.

Example 2: Jess applied for BadgerCare Plus on May 2, 2014 and was found eligible as a childless adult, with coverage beginning May 1, 2014. At the time of application, Jess requested three months of backdated coverage, through February 1, 2014. Because Jess is eligible as a childless adult and coverage cannot be backdated for childless adults prior to April 1, 2014, Jess will only receive backdated coverage in April 2014.

25.8.1.1 BadgerCare Plus Family Planning Services

Eligibility for *FPOS* begins on the first of the month of application, if all non-financial (40.4) and financial (40.5) eligibility requirements are met. FPOS may be backdated up to three months from the month of application.

25.8.1.2 Pregnant Women

Except those women eligible only under the BadgerCare Plus Prenatal Program, backdate a pregnant woman to whichever is more recent:

1. The first of the month in which the pregnancy began.
2. The first of the month, three months prior to the month of application. If a woman was pregnant before the date of her application, backdate her BadgerCare Plus even though she is not pregnant on the date of application. Do not, however, continue her eligibility as a pregnant woman beyond the end of the pregnancy. Before backdating her BadgerCare Plus, verify that she has met all the eligibility requirements during the backdated period.

See (41.5) for the BadgerCare Plus Prenatal *eligibility begin date* policy.

*this page last updated in Release Number: 14-02
Release Date: 05/14/14
Effective Date: 04/01/14*

[View History](#)

25.9 Denials and Terminations

[25.9.1 Termination](#)

[25.9.2 Denial](#)

25.9.1 Termination

If less than a calendar month has passed since a member's enrollment has been terminated, the *applicant* can provide the necessary information to reopen BadgerCare Plus without filing a new *application*.

If more than a calendar month has passed since a member's enrollment was terminated, the applicant must file a new application to reopen his or her BadgerCare Plus.

Starting with renewals due March 31, 2014, if a case is determined under *MAGI* rules and is closed at renewal due to failure to complete the renewal, including providing verification for that renewal, the individual can be reopened for BadgerCare Plus without filing a new application if he or she provides the necessary information within 90 days of the renewal date.

25.9.2 Denial

If less than 30 days has passed since the client's eligibility was denied, allow the client to re-sign and date the application or *page one* of the CAF to set a new *filing date*.

If more than 30 days has passed since a client's eligibility was denied and the client is not open for any other program, the client must file a new application to reopen his or her Medicaid.

If the client is open for any other program of assistance, do not require him or her to re-sign his or her application or sign a new application.

this page last updated in Release Number: 13-02

26 Renewal

[View History](#)

26.1 RENEWALS

[26.1.1 Renewals Introduction](#)

[26.1.2 Three-Month Late Renewals](#)

[26.1.2.1 Verification Requirements for Late Renewals](#)

[26.1.2.2 Gaps in Coverage](#)

[26.1.3 Administrative Renewals](#)

26.1.1 Renewals Introduction

A renewal is the process during which you reexamine all eligibility factors subject to change and decide if eligibility continues. The group's continued eligibility depends on its timely completion of a renewal. Each renewal results in a determination to continue or discontinue eligibility.

The first required eligibility renewal for a BadgerCare Plus case is 12 months from the certification month, except for:

1. **CENS** - The renewal date is 12 months from the date of birth.
2. **Pregnant women** -The renewal date is two calendar months after the date the pregnancy ends.

Note: Women in the BadgerCare Plus Prenatal Program lose eligibility on the date the pregnancy ends. However, they are automatically eligible for emergency services for two months after eligibility for BadgerCare Plus Prenatal Program ends (Chapter [41.6](#)).

3. **Deductibles** - A renewal is not scheduled for a case that did not meet its [deductible](#) , unless someone in the case was open for BadgerCare Plus. For cases that did meet the deductible, the renewal date is six months from the start of the deductible period.

Note: For manually certified BadgerCare Plus cases, make sure the member receives a timely notice of when the renewal is due.

Agency Option

For individuals whose eligibility is determined under *non-MAGI* rules, the agency may review any case at any other time when the agency can justify the need. Examples include:

- Loss of contact
- Member request

Note: Shortening certification periods in an attempt to balance agency workload is not permissible.

BadgerCare Plus members whose eligibility is determined using *MAGI* rules are required to complete a renewal no earlier or no later than 12 months from their certification period. Individuals whose benefits are time-limited, such as CENs or pregnant women, will not be required to do a renewal at the end of their time limited benefit if the individual is on a case with other open BadgerCare Plus assistance groups.

Once individuals' BadgerCare Plus eligibility is determined under *MAGI* rules, workers can complete an early renewal only if the member requests an early renewal. Once the member requests an early renewal, the renewal must be completed.

26.1.2 Three-Month Late Renewals

[26.1.2.1 Verification Requirements for Late Renewals](#)

[26.1.2.2 Gaps in Coverage](#)

Most health care renewals received within three months of the renewal month can be processed as a late renewal instead of requiring a new application. This policy applies to the following subprograms:

- BadgerCare Plus.
- Family Planning Only Services (FPOS).
- Elderly, Blind or Disabled Medicaid (EBD MA).
- Home and Community Based Waivers (HCBW).
- Institutional Medicaid.
- Medicaid Purchase Plan (MAPP).
- Medicare Savings Programs (QMB/SMLB/SLMB+/QDWI).

The policy applies to members receiving health care benefits based on a met deductible, but not to members with an unmet deductible.

Late renewals are only permitted for individuals whose eligibility has ended because of lack of renewal, and not for other reasons. Members whose health care benefits are closed for more than three months because of lack of renewal must reapply.

Agencies should consider late submission of an online or paper renewal form, or a late renewal request by phone or in person, to be a valid request for health care. The new certification period should be set based on the receipt date of the signed renewal. If verification is required during the completion of a late renewal, the member will have 10 days to provide it.

Example 1: Jenny's renewal is due on January 31, 2015. She submits an online renewal via ACCESS on March 15, 2015. If the renewal is processed on the same day, and verification is requested, the verification will be due on March 25, 2015. If she provides verification on or before this due date and meets all other eligibility criteria for BadgerCare Plus, her eligibility and certification period will start on March 1, 2015. Her next renewal will be due February 28, 2016.

Note: The three-month period starts from the month the renewal was due. It does not restart when a late renewal has been submitted. If Jenny submits her renewal on March 15 but does not provide verification until May, she will need to reapply after the three-month period that started with her January renewal date.

26.1.2.1 Verification Requirements for Late Renewals

If the BadgerCare Plus renewal was completed timely, but requested verifications were not provided as part of the renewal, BadgerCare Plus can reopen without a new application if these verifications are submitted within three months of the renewal month. The submission of the renewal-related verifications is considered a request for health care. Only the missing verifications must be provided. However, the verifications must include information for the current month of eligibility. If verification is submitted for a past month, a new Verification Checklist (VCL) must be generated to request the current verification, allowing 10 days to submit the verification.

For EBD Medicaid, the member must provide the missing verification and verify assets for the current month if there was a gap in coverage.

Example 2: Jenny's renewal is due on January 31, 2015. She completes her renewal on January 20, 2015, and a VCL is generated requesting income verification for the 30 days prior to January 20. Jenny does not submit the requested verification, and her BadgerCare Plus eligibility is terminated as of January 31, 2015. On April 27, 2015, she submits her paystubs for April 10 and April 24. If she meets the eligibility criteria for BadgerCare Plus, her certification period will start on April 1, 2015, and her next renewal will be due March 31, 2016. If she had submitted the verification of her income for January, a new VCL should be generated asking for verification of her current income for April.

26.1.2.2 Gaps in Coverage

If a member has a gap in coverage because of his or her late renewal, he or she may request coverage of the past months in which the gap occurred. Backdated coverage under the late renewal policy is available to all BadgerCare Plus members who meet program rules, including children who would not otherwise qualify for backdated coverage because their income is too high (see Chapter [25.8.1](#)). However, this does not change the rules for backdating at application.

If a member requests coverage for past months during a late renewal, he or she must provide all necessary information and verifications for those months (including verification of income for all months requested) and must pay any required premiums to be covered for those months.

26.1.3 Administrative Renewals

Administrative Renewals through December 31, 2013

An administrative renewal is an extension of program eligibility for certain low-risk cases based on the information in *CARES* as of the month prior to the renewal month. Cases selected for administrative renewal are cases that are highly unlikely to lose eligibility at renewal due to increases in income or assets.

The extension of program eligibility under an administrative renewal is based on the information in *CWW* as of the month prior to the month a full renewal would otherwise have been due. An administrative renewal case will not receive an eligibility renewal notice and is not required to provide the IM agency with any additional information in order to have program eligibility continued.

Administrative renewal cases remain subject to change reporting requirements. The administrative renewal notice identifies program specific change reporting requirements, as well as the potential consequences for not reporting changes timely. Changes reported for a case that has undergone an administrative renewal should be processed under existing policy.

BadgerCare Plus cases selected for administrative renewal must meet all the following criteria:

- No child in household turning 18 in current or next month
- Countable income at or below 75% FPL
- No premium
- No open FoodShare, Child Care or W-2

Through December 31, 2013, Family Planning Only Services (*FPOS*) cases selected for administrative renewal must meet all the following criteria:

- No child in household turning 18 in current or next month
- Countable income of individuals age 18 and older at or below 275% FPL

Open for Multiple Programs

If the case is open for MSP and BadgerCare Plus (BCP) or FPOS, the case may be selected for administrative renewal if the BCP/FPOS renewal is due and the case meets all the selection criteria listed above. If the MSP renewal is due but not the BCP/FPOS renewal, or the case does not meet all the selection criteria listed above, the case will not be selected for administrative renewal.

Continuous Eligibility

To be selected for an administrative renewal, the case must be open and currently eligible with continuous program eligibility for at least the twelve month period prior to the month in which the case is being considered for an administrative renewal. Additionally, the case must have had at least one full regular renewal.

Alternate Years

Cases will not be selected for administrative renewal if the last renewal requirement was met through an administrative renewal. Administrative renewals will be done every other year. The exceptions to this rule are:

- HCBW or MLTC members who are Group A due to their eligibility for SSI or 1619b.
- Family Planning Only Services cases where the only eligible case member is under 18 and will not turn age 18 in the current or next month.

Persons meeting these criteria may be selected for administrative renewal annually as long as the detailed selection criteria are met.

Schedule

Administrative renewal case selection will occur prior to sending the regular renewal notices. Any cases not selected for an administrative renewal will be sent the regular renewal notice.

Renewal Mode

Cases in renewal mode will not be selected for administrative renewal.

CARES

CWW will automatically:

- Select cases subject to administrative renewal,
- Determine the continued eligibility, **and**
- Notify the member of the administrative renewal and eligibility determination.

Worker intervention is not necessary to complete the administrative renewal process. Cases selected for Administrative Renewal will run through a batch eligibility process. Cases that have a pending or fail status after running through the batch eligibility process will not continue through the Administrative Renewal process and will be set for regular renewal.

Cases that are passing after eligibility batch run will go through the administrative renewal confirmation process.

During the confirmation process:

- Case level renewal dates are set.
- A case comment is added indicating that the case has gone through an Administrative Renewal.
- The [Application](#)/Review Interview Details page will display 'Admin Renewal'.
- The Notice of Decision process is triggered and will generate an administrative renewal letter. The letter will be stored in the ECF.
- The Enrollment and Benefit brochure is sent to the customer.

Administrative Renewals Effective January 1, 2014

Effective January 1, 2014, administrative renewals will be suspended for BadgerCare Plus and FPOS cases.

*This page last updated in Release Number: 15-01
Release Date: 05/15/2015
Effective Date: 05/15/2015*

[View History](#)

26.2 Choice of REnewal

The member has the choice of the following methods for any BC + renewal:

1. Face-to-Face Interview.
2. Mail-In (paper [application](#) or pre-printed renewal packet).
3. Telephone Interview.
4. ACCESS (<https://access.wisconsin.gov/access/>)

*his page last updated in Release Number: 13-02
Release Date: 10/25/13
Effective Date: 10/01/13*

[View History](#)

26.3 Renewal Processing

A BadgerCare Plus eligibility renewal notice is generated in the 2nd week of the 11th month of the *certification period*. Do not schedule a renewal until after *adverse action* in the month prior to the month of renewal.

Example 1: [CARES](#) sends out the renewal letter the 2nd week of July for a review due in August. Do not schedule the renewal for a date prior to adverse action in July.

Do not require a new *Authorized Representative* form at renewal, if the person signing the renewal is the Authorized Representative on file. If the renewal is not completed by the end of the certification period, the case will close. The closure notice is generated through CARES, at adverse action in the renewal month.

*This page last updated in Release Number: 13-02
Release Date: 10/25/13
Effective Date: 10/01/13*

27 Change Reporting

[View History](#)

27.1 CHANGES REPORTED DURING THE APPLICATION PROCESSING PERIOD

For applications, changes that occur between the *filing date* and confirmation date must be reported and considered in the eligibility determination. Changes that are reported after certification must be acted on in the same manner as any other reported change.

*This page last updated in Release Number: 07-01
Release Date: 10/29/07
Effective Date: 02/01/08*

[View History](#)

27.2 NON- FINANCIAL CHANGE REPORTING REQUIREMENTS

27.3 Income Change Reporting Requirements

BadgerCare Plus members whose eligibility is determined under *non-MAGI* rules must report the following non-financial changes within 10 days after occurrence:

- Address
- Household composition, including pregnancy and changes to the pregnancy of a BadgerCare Plus member
- Living arrangement (e.g. institutionalization, incarceration, etc.)
- Change in marital status

BadgerCare Plus members whose eligibility is determined under *MAGI* rules must report the following non-financial changes within 10 days after occurrence:

- Address
 - Household composition, including pregnancy and changes to the pregnancy of a BadgerCare Plus member
 - Living arrangement (e.g. institutionalization, incarceration, etc.)
 - Change in marital status
 - Change in insurance coverage
 - Change in expected tax filing status
 - Change in tax dependents
 - No longer receiving a tax-related deduction

this page last updated in Release Number: 13-02

Release Date: 10/25/13

Effective Date: 10/01/13

[View History](#)

27.3 INCOME CHANGE REPORTING REQUIREMENTS

BadgerCare Plus members whose eligibility is determined under *non-MAGI* rules must report income changes when their total monthly gross income exceeds the following percentages of the *FPL* for their group size.

- 100% FPL
- 133% FPL
- 150% FPL
- 185% FPL
- 200% FPL
- 250% FPL
- 300% FPL

- 350% FPL
- 400% FPL

BadgerCare Plus members whose eligibility is determined under *MAGI* rules, income changes must be reported when the total monthly income of the assistance group with the highest monthly income amount exceeds the following FPL percentages for their assistance group size:

- 100% FPL
- 133% FPL
- 156% FPL
- 191% FPL
- 200% FPL
- 250% FPL
- 306% FPL
- 350% FPL
- 400% FPL

The income change must be reported by the 10th of the month following the month in which the total income exceeded its previous threshold.

Adults in a BadgerCare Plus Extension who are required to pay a premium must also report and verify income changes during the extension *certification period*. Eligibility for adult members who would be required to pay premiums will be terminated for failure to submit requested verification. Effective April 1, 2014, all non-exempt parents and caretakers in BadgerCare Plus Extensions will be required to pay a premium. However, parents and caretakers with income between 100 and 133% FPL will not be subject to premiums until the seventh calendar month of their extension.

The *CARES* notice will indicate the dollar amount associated with each FPL level, for the BadgerCare Plus group size.

Example 1: Sally's countable family income has been at 80% of the FPL since she applied in January. In June her income increased to 107%, so she must report the change by July 10th.

Example 2: Heidi's countable family income is 128% of the FPL. In September it increased to 164% of the FPL. Heidi must report this change by October 10th.

Example 3: Steve's countable family income is 265% of the FPL. In December it increased to 411% of the FPL. Steve must report this change by January 10th.

Effective Date: 02/01/14

[View History](#)

27.4 OTHER REPORTED CHANGES

Any other change that is reported or becomes known to the agency (i.e., through data exchange) must be acted upon.

This page last updated in Release Number: 07-01

Release Date: 10/29/07

Effective Date: 02/01/08

[View History](#)

27.5 CHANGE REPORTING REQUIREMENTS FOR BADGERCARE PLUS FAMILY PLANNING ONLY SERVICES MEMBERS:

There are only two changes that BadgerCare Plus Family Planning Only Services members need to report during the *certification period*:

- Address or
- Living arrangement (e.g. incarceration, institutionalization)

These changes must be reported within ten days of occurrence.

This page last updated in Release Number: 13-01

Release Date: 02/28/13

Effective Date: 02/28/13

28 Corrective Action

[View History](#)

28.1 OVERPAYMENTS

An “overpayment” occurs when BadgerCare Plus benefits are paid for someone who was not eligible for them or when BadgerCare Plus premium calculations are incorrect.

The amount of recovery may not exceed the amount of the BadgerCare Plus benefits incorrectly provided. Some examples of how overpayments occur are:

1. Concealing or not reporting income.
2. Failure to report a change in income.
3. Providing misinformation at the time of *application* regarding any information that would affect eligibility.

Note: Overpayments can only be recovered if the member failed to report a change for which they were notified they were required to report.

*this page last updated in Release Number: 13-02
Release Date: 10/25/13
Effective Date: 10/01/13*

[View History](#)

28.2 RECOVERABLE OVERPAYMENTS

Initiate recovery for a BadgerCare Plus overpayment, if the incorrect payment resulted from one of the following:

1. [Applicant/Member Error](#)

Applicant/Member error exists when an applicant, member or any other person responsible for giving information on the member's behalf unintentionally misstates (financial or non-financial) facts, which results in the member receiving a benefit that he or she is not entitled to or more benefits than he or she is entitled to. Failure to report non-financial facts that impact eligibility or cost share amounts is a recoverable overpayment.

Applicant/Member error occurs when there is a:

a. Misstatement or omission of facts by a member, or any other person responsible for giving information on the member's behalf at a BC + [application](#) or review.

or

b. Failure on the part of the member, or any person responsible for giving information on the member's behalf, to report required changes in financial ([27.3](#)) (income, expenses, etc.) or non-financial ([27.2](#)) information that affects eligibility, premium, patient liability or cost share amounts.

An overpayment occurs if the change would have adversely affected eligibility, the benefit plan or the premium amount.

Example 1: Joe and his family were determined eligible for BadgerCare Plus with a \$100.00 total group premium in July. In November, Joe's worker learned that Joe had received a raise September 1st that Joe was required to report by October 10th. The amount of the new family income increased the premium amount to \$130.00. The worker entered the new income in [CARES](#) and confirmed the increase in the premium amount for December.

What can now be recovered?

Because Joe did not report the increase in income to his worker, the premium amount for November is incorrect. The overpayment amount would be the difference between the correct premium for November and the premium amount that was paid.

Example 2: Sally was determined eligible for BadgerCare Plus Standard Plan in January. In May, the worker discovered that at application Sally had not reported the income from a part time job. The unreported income would have put Sally into the Benchmark Plan with a \$30.00 premium. The worker entered the income in CARES and confirmed the premium and the change from the Standard plan to the Benchmark plan effective June 1st.

What can now be recovered?

The overpayment for the months of January through May is the \$30.00 per month premium amount plus the difference in the co-pays and [deductible](#) amounts for services that she should have paid under the Benchmark plan.

Example 3: John and his family were determined eligible for BadgerCare Plus in June. John accepted a new job in South Carolina and the family moved out of state on July 20th. Since they were no longer residents of Wisconsin, they were no longer eligible for BadgerCare Plus. However, because their move to South Carolina was not reported, capitation payments continued to be made for John and his family until the worker closed the case effective December 31st.

What can now be recovered?

Giving 10 days to report and following AA logic, the case would have closed August 31. Fee-For-Service claims and/or HMO capitation payments for September, October, November and December are recoverable.

Example 4: Susan was determined eligible for BadgerCare Plus in January. She was pregnant with a due date of August 15th. On February 3rd, she miscarried but did not report this change to her worker. Her BadgerCare Plus eligibility continued

until the worker closed the case effective October 31st. Once she was no longer pregnant, she would only have remained eligible for an additional 60 days after the last day of pregnancy through the end of the month in which the 60th day occurs. Susan was not eligible for the months May through October.

What can now be recovered?

The change should have been reported in February. Allowing for the 2 month extension, BadgerCare Plus should have closed April 30. The overpayment amount is the amount of the Fee-For-Service claims and the capitation payment made for her from May through October.

2. Fraud

Fraud is also known as Intentional Program Violation (IPV).

Fraud exists when an applicant, member or any other person responsible for giving information on the member's behalf does any of the following:

1. Intentionally makes or causes to be made a false statement or representation of fact in an application for a benefit or payment.
2. Intentionally makes or causes to be made a false statement or representation of a fact for use in determining rights to benefits or payments.
3. Having knowledge of an event affecting initial or continued right to a benefit or payment and intentionally failing to disclose such event.
4. Having made application to receive a benefit or payment and intentionally uses any or all of the benefit or payment for something other than the intended use and benefit of such persons listed on the application.

If there is a suspicion that fraud has occurred, see [28.6](#) for information about referral to the District Attorney (DA).

3. Member Loss of an Appeal

Benefits a member receives as a result of a fair hearing request order can be recovered, if the member loses the appeal.

A member may choose to continue to receive benefits pending an appeal decision. If the appeal decision is that the member was ineligible, the benefits received while awaiting the decision can be recovered. If an appeal results in an

increased patient liability, cost share, or premium, recover the difference between the initial amount and the new amount.

*This page last updated in Release Number: 12-02
Release Date: 10/05/12
Effective Date: 07/01/12*

[View History](#)

28.3 NON-RECOVERABLE OVERPAYMENTS

Do not initiate recovery for a BadgerCare Plus overpayment if it resulted from a non-member error, including the following situations:

1. The member reported the change timely, but the case could not be closed or the benefit reduced due to the 10-day notice requirement.
2. Agency error (keying error, math error, failure to act on a reported change, etc).
3. Normal prospective budgeting projections based on best available information.

Example: Susan and her daughter Kathy are open for BadgerCare Plus. Susan reported a change in income on April 1st. The worker did not process the change until April 28th, so it was not effective until June 1st. There is no overpayment for May since the change was reported timely, but not acted on by the worker until after *adverse action*.

*This page last updated in Release Number: 07-01
Release Date: 10/29/07
Effective Date: 02/01/08*

[View History](#)

28.4 OVERPAYMENT CALCULATION

[28.4.1 Overpayment Period](#)

[28.4.2 Overpayment Amount](#)

[28.4.3 Overpayments for Individuals Eligible for Family Planning Services \(FPS\)](#)

[28.4.4 Determining Liable Individual](#)

28.4.1 Overpayment Period

Misstatement or Omission of Fact

If the overpayment is a result of a misstatement or omission of fact during an initial BadgerCare Plus *application* or review, determine the period for which the benefits were determined incorrectly and determine the appropriate overpayment amount ([28.4.2](#)).

Failure to Report

For ineligible cases, if the overpayment is a result of failure to report a required change, calculate the date the change should have been reported and which month the case would have closed or been adversely affected if the change had been reported timely.

Fraud/IPV

For ineligible cases, if the overpayment was the result of fraud, determine the date the fraudulent act occurred. The period of ineligibility should begin the date the case would have closed or been adversely affected allowing for proper notice. If an overpayment exists, but the case is still being investigated for fraud, establish the claim so collection can begin promptly. Prosecution should not delay recovery of a claim.

The ineligible period should begin with the application month.

28.4.2 Overpayment Amount

Use the actual income that was reported or required to be reported in determining if an overpayment has occurred.

If the case was ineligible for BadgerCare Plus, recover the amount of medical claims paid by the state and/or the capitation rate. Use the ForwardHealth interChange data from the Total Benefits Paid by Medicaid Report(s). Deduct any amount paid in premiums (for each month in which an overpayment occurred) from the overpayment amount.

If the case is still eligible for BadgerCare Plus for the timeframe in question, but there was an increase in the premium, recover the difference between the premiums paid and the amount owed for each month in question. To determine the difference, determine the premium amount owed and view the premium amount paid on *CARES* screen AGPT.

The overpayment amount is the difference between the premium paid and premium owed even if the premium that was paid was \$0.

<p>Example: Tom and his family became eligible for BadgerCare Plus in June 2008, without a premium. In his application Tom failed to disclose income from a second job which would have resulted in \$100 per month group premium. All individuals in the group remained eligible for BadgerCare Plus. This new information was</p>
--

discovered in July 2008.

Overpayment Calculation	
	\$100 premium owed for June
	+ \$100 premium owed for July
	<u>\$200 Total premium owed</u>
	- \$ 0 premium paid
	<u>\$200 Overpayment</u>

If the unreported information would have placed the individual in the Benchmark plan instead of the Standard plan, the overpayment amount would be the difference in the co-pays and deductibles for the services provided.

If a member error increases a *deductible* amount before the deductible is met, there is no overpayment. Recalculate eligibility and notify the member of the new deductible amount.

If the member met the incorrect deductible and BadgerCare Plus paid for services after the deductible had been met, there is an overpayment. Recover the difference between the correct deductible amount and the previous deductible amount or the amount of claims over the six month period (whichever is less).

If the member was ineligible for the deductible, determine the overpayment amount. If the member prepaid his or her deductible, deduct any amount he or she paid toward the deductible from the overpayment amount.

28.4.3 Overpayments for Individuals Eligible for Family Planning Only Services (FPOS)

If an individual or case was ineligible for Medicaid or BadgerCare Plus but would have been eligible for *FPOS*, the calculation of the BC +overpayment amount is as follows:

1. If the incorrect/overpaid FPOS costs were “fee for service” medical claims paid by the state, recover the amount of benefits that were actually paid by the state minus any BadgerCare Plus premiums which the member may have paid and the amount of any actual FPOS services that were provided.
2. If the incorrect /overpaid BadgerCare Plus benefits were paid by an HMO, recover the HMO capitation rate paid by the state minus any premiums which the member may have paid and the “average” monthly cost of the FPOS.

28.4 4 Determining Liable Individual

Except for minors, collect overpayments from the BadgerCare Plus member, even if the member has authorized a representative to complete the application or review for him or her.

If a minor received BadgerCare Plus in error, make the claim against the minor's parent(s) or legally responsible relative, if the parent or legally responsible relative was living with the minor at the time of the overpayment.

*This page last updated in Release Number: 13-02
Release Date: 10/24/13
Effective Date: 10/01/13*

[View History](#)

28.5 MEMBER NOTICE

Notify the member or the member's representative of the period of ineligibility, the reason for his or her ineligibility, the amounts incorrectly paid, and request arrangement of repayment within a specified period of time.

*This page last updated in Release Number: 07-01
Release Date: 10/29/07
Effective Date: 02/01/08*

[View History](#)

28.6 REFER TO DISTRICT ATTORNEY

See [IMM Chapter 11 Program Fraud Overview](#) for referral criteria when fraud is suspected. The agency may refer the case to the Department of Health Services (DHS) Office of the Inspector General (OIG) where fraudulent activity by the member is suspected. If the investigation reveals a member may have committed fraud, refer the case to the district attorney, corporation counsel for investigation, or OIG. The district attorney or corporation counsel may prosecute for fraud under civil liability statutes. The agency may seek recovery through an order for restitution by the court of jurisdiction in which the member or former member is being prosecuted for fraud.

*his page last updated in Release Number: 13-02
Release Date: 10/25/13
Effective Date: 10/25/13*

[View History](#)

28.7 FAIR HEARING

The IM agency's decision concerning ineligibility and amounts owed may be appealed through a fair hearing. During the appeal process the agency may take no further recovery actions pending a decision.

*This page last updated in Release Number: 07-01
Release Date: 10/29/07
Effective Date: 02/01/08*

[View History](#)

28.8 AGENCY RETENTION

The *IM* agency can retain 15 percent of the payments recovered (see [Income Maintenance Manual Section 13.8 Local Agency Retention Portion of Claims](#)).

*This page last updated in Release Number: 16-01
Release Date: 02/15/2016
Effective Date: 02/15/2016*

[View History](#)

28.9 RESTORATION OF BENEFITS

If it is determined that a member's benefits have been incorrectly denied or terminated, restore his or her BadgerCare Plus from the date of the incorrect denial or termination through the time period that he or she would have remained eligible.

If the member was incorrectly denied or terminated for BadgerCare Plus with a premium obligation, allow the member to pick which months he or she would like to receive benefits.

Collect all premiums owed for those prior months before certifying the member for the months he or she chose.

If a member already paid for a BadgerCare Plus covered service, inform the member that he or she will need to contact his or her provider to bill BadgerCare Plus for services provided during that time. A BadgerCare Plus provider must refund the amount that BadgerCare Plus will reimburse for the service. The provider may choose to refund up to the full amount billed to the member, but that decision is entirely optional.

28.9.1 Premiums

If it is determined that a premium amount was incorrectly calculated for BadgerCare Plus and would result in a refund for the member, determine the correct premium amount for each month in which it was incorrect and report the error to the fiscal agent's BadgerCare Plus Unit. The *fiscal agent* will refund the amount of the premium the member overpaid. The report can be made either by:

1. Telephone: 1 (888) 907-4455 or
2. Fax: (608) 251-1513

When submitting a fax, write "Attn: BadgerCare Plus Premium Refunds".

When reporting the refund to the BadgerCare Plus Unit, include the:

1. The member's Social Security Number.
2. Months for which a refund needs to be issued.
3. New premium amount.
4. Old premium amount.

Indicate whether there is a hardship situation that requires the refund to be processed more quickly.

Occasionally, a BadgerCare Plus member is certified for retroactive Katie Beckett or SSI eligibility for a period of time in which they were also certified for BadgerCare Plus. If the BadgerCare Plus member paid a premium during this time frame, they are entitled to a refund of any BadgerCare Plus premiums that they paid during the retroactive Katie Beckett or SSI *certification period*.

*This page last updated in Release Number: 10-02
Release Date: 10/29/07
Effective Date: 02/01/08*

29 Notices and Fair Hearings

[View History](#)

29.1 NOTICES

A notice must be either mailed or sent electronically at least 10 days prior to a negative action, such as a termination of benefits or an increase in premium.

*This page last updated in Release Number: 16-01
Release Date: 02/15/2016
Effective Date: 02/15/2016*

[View History](#)

29.2 FAIR HEARINGS

Members have the right to a fair hearing, timely case decisions, and accurate notices of decision. See [Chapter 3](#) of the IMM for specifics.

*This page last updated in Release Number: 07-01
Release Date: 10/29/07
Effective Date: 02/01/08*

30 Affirmative Action

[View History](#)

30.1 AFFIRMATIVE ACTION AND CIVIL RIGHTS

The Rehabilitation Act of 1973, requires a person with impaired sensory, manual or speaking skills have an opportunity to participate in programs equivalent to those afforded non-disabled persons.

Assistance must be provided to all BadgerCare Plus members to assure effective communication. This includes certified interpreters for deaf persons and translators for non-English speaking persons. See the Wisconsin BadgerCare Plus Enrollment and Benefits brochure ([P-00079](#)).

The Civil Rights Act of 1964 requires that applicants for public assistance have an equal opportunity to participate regardless of race, color, or national origin.

*This page last updated in Release Number: 07-01
Release Date: 10/29/07
Effective Date: 02/01/08*

31 Interagency Transfer

[View History](#)

31.1 INTERAGENCY TRANSFER

A case transfer occurs when the primary person receiving benefits from a county or tribal Income Maintenance agency for a particular month, applies for aid from another Income Maintenance agency for the same or next month. The primary person must be a member of a currently open BadgerCare Plus, Child Care, EBD Medicaid, Food Share, or W2 Assistance Group or one that has been closed for less than a calendar month.

The agency to which the member reports the move must collect information about the changes, for example, the new address. If the agency does not have sufficient information about the changed circumstances, it must request information from the member, according to the BadgerCare Plus verification policy ([Chapter 9](#)).

The renewal date will remain the same after case transfer.

Do not require a renewal or new *application* for case transfers, except in the following programs:

- Community Waivers (EBD-MEH [Chapter 28.1](#))
- Family Care (EBD-MEH [Chapter 29.1](#))
- [Deductible](#) Met (EBD-MEH [Chapter 24.2](#))

See [6.1](#) of the Process Help for information on how to process case transfers.

*this page last updated in Release Number: 13-02
Release Date: 10/25/13
Effective Date: 10/01/13*

32 Presumptive Eligibility

[View History](#)

32.1 PRESUMPTIVE ELIGIBILITY (PE) FOR CHILDREN

[32.1.1 Eligible Children for PE](#)

[32.1.2 Qualified Entities](#)

32.1 Presumptive Eligibility (PE) for Children

Note: Wisconsin's presumptive eligibility programs are known by multiple terms: Express Enrollment, Temporary Enrollment, and Presumptive Eligibility. Express Enrollment (EE) is the **online application** in ACCESS for making PE determinations. Presumptive Eligibility (PE) is the **determination** of whether an applicant is eligible to temporarily enroll in BadgerCare Plus (BadgerCare Plus) or Family Planning Only Services (FPOS). Temporary Enrollment (TE) is when an applicant has been found **eligible to temporarily enroll** in BadgerCare Plus or FPOS. All such policy in this handbook will be collectively referred to as Presumptive Eligibility.

32.1.1 Eligible Children for PE

Children can be presumptively eligible for BadgerCare Plus if they meet the following financial and non-financial criteria:

1. Under age 19 (Minors under age 18 must apply with a parent/guardian)
2. A U.S. citizen or lawfully present in the United States (no requirement for the amount of time the person is lawfully present in the US) and
3. Through January 31, 2014:
 1.
 - If the child is younger than age 1, the family's gross income must be at or below 300% of the Federal Poverty Level.
 - If the child is age 1 through 5, the family's gross income must be at or below 185 % of the Federal Poverty Level.
 - If the child is age 6 through 18, the family's gross income must be at or below 150 % of the Federal Poverty Level.
4. Effective February 1, 2014
 - If the child is younger than age 1, the child's assistance group's (AGs) income must be at or below 306% of the Federal Poverty Level (FPL).
 - If the child is age 1 through 5, the child's AGs income must be at or below 191 % of the FPL.
 - If the child is age 6 through 18, the child's AGs income must be at or below 156% of the FPL.

Note: See section [16.1.2](#) for additional information on *MAGI* income disregards.

PE can begin on the day on which a qualified entity determines that the child meets the criteria listed above by completing an application for a PE determination through ACCESS for Partners and Providers (APP).

A child is allowed to have only one period of PE in a 12 month period.

32.1.2 Qualified Entities

Qualified entities that can be certified by ForwardHealth to temporarily enroll children in BadgerCare Plus through the Express Enrollment program include:

1. Medicaid (MA) Providers.
2. Head Start (HS) programs.
3. Authorized Child Care (CC) providers.
4. WIC agencies.
5. Faith-based organizations such as the YMCA.
6. Certain Community-based organizations such as the Boys and Girls Club.
7. Authorized agencies offering emergency food and shelter.
8. Elementary and secondary schools.
9. Qualified Hospitals
10. Any other entity the state so deems as approved by the Secretary.

Once certified by the *fiscal agent* to enroll children through the presumptive eligibility category, the qualified entity will:

1. Complete an online PE application through ACCESS for Partners and Providers designed for PE determinations.
2. Provide a temporary BadgerCare Plus card for the child if he or she meets the non-financial and financial criteria for PE.
3. Provide a denial notice to the child if he or she does not meet the requirements for PE.
4. Advise the [applicant](#) that a ForwardHealth card will replace the temporary card and provide BadgerCare Plus benefits for up to two months. (The card will be received within 3-5 business days.)
5. Stress the importance of applying through the local agency for ongoing BadgerCare Plus eligibility. In addition, they will advise applicants that they may apply for BadgerCare Plus via the Internet through the ACCESS web site, over the telephone, through the mail or in person.

If an application is made for BadgerCare Plus at the local IM agency by the end of the month following the month in which the child was determined presumptively eligible, the enrollment period ends the day on which the agency completes processing the BadgerCare Plus application, regardless of the result of the eligibility determination.

If a full BadgerCare Plus application is not submitted by the end of the month following the month in which the child was temporarily enrolled, the PE period ends the last day of the month following the month in which the child was enrolled.

Example: Joe Green applied for BadgerCare Plus PE for his son Jim on February 4th at the Center Street Boys Club. Jim was found presumptively eligible for

BadgerCare Plus from February 4th through March 31st. Joe submits a BadgerCare Plus ACCESS application to the local IM agency on February 10th. The agency completes processing the application on March 1st. Jim is found ineligible for BadgerCare Plus for February and March and the application is denied. A notice is sent to Joe informing him Jim is not eligible for BadgerCare Plus and his BadgerCare Plus presumptive eligibility is terminated effective March 1st.

*This page last updated in Release Number: 14-03
Release Date: 09/05/14
Effective Date: 02/01/14*

[View History](#)

32.2 PRESUMPTIVE ELIGIBILITY (PE) FOR PREGNANT WOMEN

[32.2.1 Eligible Pregnant Women for PE](#)

[32.2.2 Qualified Entities](#)

Note: Wisconsin's presumptive eligibility programs are known by multiple terms: Express Enrollment, Temporary Enrollment, and Presumptive Eligibility. Express Enrollment (EE) is the **online application** in ACCESS for making PE determinations. Presumptive Eligibility (PE) is the **determination** of whether an applicant is eligible to temporarily enroll in BadgerCare Plus (BadgerCare Plus) or Family Planning Only Services (FPOS). Temporary Enrollment (TE) is when an applicant has been found **eligible to temporarily enroll** in BadgerCare Plus or FPOS. All such policy in this handbook will be collectively referred to as Presumptive Eligibility.

32.2.1 Eligible Pregnant Women for PE

A Medicaid qualified entity certified by ForwardHealth can temporarily enroll a pregnant woman in BadgerCare Plus through the Express Enrollment program.

BadgerCare Plus Express Enrollment (EE) for pregnant women provides pregnancy related out patient care, including pharmacy services, to pregnant women who are presumptively eligible for BadgerCare Plus by meeting the following financial and non-financial criteria:

1. Currently pregnant,
2. A U.S. Citizen or lawfully present in the United States (no requirement for the amount of time the person is lawfully present in the U.S.), and
3. Through January 31, 2014,
 - Family income at or below 300% of FPL
4. Effective February 1, 2014,

- Has AG income at or below 306% of the FPL, and
- Has not been found presumptively eligible for BadgerCare Plus through EE for Pregnant Women at any time during her current pregnancy.

Through January 31, 2014, if the pregnant woman's income is at or below 200% of the FPL, she will be eligible for prenatal services under the Standard Plan, if it is between 201% and 300% of the FPL, she will be eligible for prenatal services under the Benchmark Plan. Beginning February 1, 2014, she will be eligible for out-patient services under the Standard Plan, regardless of her income at or below 306% of the FPL.

32.2.2 Qualified Entities

The qualified entity will:

1. Medically verify the pregnancy.

Note: Pregnancy will no longer be required to be verified for PE effective February 1, 2014.

2. Complete a BadgerCare Plus PE for Pregnant Women [application](#) .
3. Provide a temporary BadgerCare Plus card if she meets the non-financial and financial criteria for PE.
4. Provide a denial notice if she does not meet the requirements for PE.
5. Advise the [applicant](#) that a ForwardHealth Card will replace the temporary card and provide prenatal services through BadgerCare Plus for up to two months. (The new card will be received within 3-5 business days.)
6. Stress the importance of applying through the local agency for ongoing BadgerCare Plus eligibility. And, advise that the application can be submitted through <https://access.wisconsin.gov/>, over the telephone, through the mail or in person.

The qualified entity will also:

1. Submit the completed PE application form to the fiscal agent.
2. When circumstances allow, assist the woman in completing and submitting the BadgerCare Plus application with the IM agency.

If she applies for ongoing BadgerCare Plus by the end of the month following the month in which she was found presumptively eligible, the enrollment period ends the day on which the agency determines her eligibility, regardless of the result of the determination.

If she does not apply by the end of the month following the month in which she was enrolled through PE for pregnant women, the PE period ends the last day of the month following the month in which she was determined eligible for PE for pregnant women.

Example: Sandra was enrolled in BadgerCare Plus through the EE for Pregnant Women Program from January 10th through February 28th. She applied for ongoing BadgerCare Plus eligibility through the IM agency on January 15th and was found eligible effective January 1st. Her PE will end because the BadgerCare Plus eligibility will retroactively cover her with full benefits.

*This page last updated in Release Number: 14-03
Release Date: 09/05/14
Effective Date:02/01/14*

[View History](#)

32.3 PRESUMPTIVE ELIGIBILITY FOR ADULTS

[32.3.1 Eligible Adults for PE](#)

[32.3.2 Qualified Entities](#)

Note: Wisconsin's presumptive eligibility programs are known by multiple terms: Express Enrollment, Temporary Enrollment, and Presumptive Eligibility. Express Enrollment (EE) is the **online application** in ACCESS for making PE determinations. Presumptive Eligibility (PE) is the **determination** of whether an applicant is eligible to temporarily enroll in BadgerCare Plus (BadgerCare Plus) or Family Planning Only Services (FPOS). Temporary Enrollment (TE) is when an applicant has been found **eligible to temporarily enroll** in BadgerCare Plus or FPOS. All such policy in this handbook will be collectively referred to as Presumptive Eligibility.

32.3.1 Eligible Adults for PE

Adults (parents, caretakers and childless adults) can be found presumptively eligible for BadgerCare Plus if they meet the following financial and non-financial criteria:

1. Has assistance group income at or below 100% of the FPL, and
2. Is one of the following:
 - U.S. Citizen,
 - Lawfully residing in the United States for at least 5 years,
 - Lawfully residing in the United States and a refugee or is seeking asylum,
 - From Cuba or Haiti and is lawfully residing in the United States, or
 - Lawfully residing in the United States under one of the eligible immigration statuses listed in section [4.3.4](#).

Adults will be limited to one PE period within a rolling 12-month period, starting with the effective date of the initial PE period. Qualified hospitals are required to assist applicants with the completion of the full BadgerCare Plus application.

Note: Please see the [Medicaid Eligibility Handbook \(MEH\) Chapter 36.2.2.1](#) for information on PE under the Wisconsin Well Women Medicaid (WWMA) program for women under age 65 with breast or cervical cancer.

32.3.2 Qualified Entities

Qualified hospitals certified by ForwardHealth can make presumptive eligibility determinations for adults.

Qualified hospitals will be allowed to make PE determinations for patients who are inmates of public correctional institutions that are not state correctional facilities (e.g., county jails) as long as those patients are expected to remain in the hospital for 24 hours or more. The PE determination process for these patients will be the same as for other patients. Patients who are inmates of a state correctional facility are not eligible for Medicaid or BadgerCare Plus through the hospital PE process.

If an application is made for BadgerCare Plus at the local agency by the end of the month following the month in which the individual was determined presumptively eligible, the enrollment period ends the day on which the agency completes processing the BadgerCare Plus application, regardless of the result of the eligibility determination.

If a BadgerCare Plus application is not submitted by the end of the month following the month in which the individual was temporarily enrolled, the PE period ends the last day of the month following the month in which the individual was enrolled.

This page last updated in Release Number: 14-03

Release Date: 09/05/14

Effective Date:02/01/14

[View History](#)

32.4 AT THE IM AGENCY

If an individual who has been determined presumptively eligible for BadgerCare Plus applies for full BadgerCare Plus at the IM agency on or before the last day of the PE period:

- Verify the individual is temporarily enrolled by checking his or her temporary BadgerCare Plus ID card or MMIS.

- Assist him or her in filing the application. Consider the application filed if his or her name, address and signature are on the application.

If you are unable to finish processing the application by the end of her PE period, extend the enrollment period for an additional calendar month. Prior to the last date of the PE period, complete a paper Medicaid/BadgerCare Plus Certification form (F-10110, former DES 3070) and send to the fiscal agent or extend the PE eligibility through the manual certification process in the [ForwardHealth portal](#). Enter the extended date for the PE enrollment for the individual and use the following medical status codes:

For enrollment period extensions to a date up through January 31, 2014:

Med Stat	Population
BU	Children
BV	Pregnant women eligible under the Standard Plan
BW	Pregnant women eligible under the Benchmark Plan

Note: Beginning February 1, 2014, all eligible PE women at or below 306% of the FPL will be eligible under the Standard Plan. PE for parents, caretakers and childless adults is not effective until April 1, 2014, so no enrollment period extension is available to these individuals prior to this date.

For enrollment period extensions to a date after February 1, 2014:

Med Stat	Population
9J	Children under age 1 with AG income above 200% FPL and at or below 306% FPL
7Q	Children under age 1 with AG income above 133% FPL and at or below 200% FPL
EC	Children under age 1 with AG income at or below 133% FPL
7S	Children age 1 through 5 with AG income above 156% FPL and at or below 191% FPL
BU	Children age 1 through 18 with AG income at or below 156% FPL
9E	Pregnant women with AG income above 200% FPL and at or below 306% FPL
BV	Pregnant women with AG income at or below 200% FPL
PP	Parents and caretakers*
PN	Childless adults*

* The medical status codes PP and PN are not effective until April 1, 2014.

Once the full BadgerCare Plus application is processed, if the individual is found ineligible for BadgerCare Plus, complete a negative notice ([F-16001](#)) to end the PE period. Check box three and complete the sentence to read: "Your temporary enrollment for pregnant women benefits will be stopped effective (write in date)". Under "Explanation of Action," write the reason BadgerCare Plus is being denied. Indicate the statutory authority is S. 49.471, Stats.

Mail one copy to the woman and one to the qualified provider. Complete a Medicaid/BadgerCare Plus Manual Certification form F-10110 (formerly DES 3070), indicating the EE for pregnant women end date, and send to the *fiscal agent*. The PE end date is the day the woman is found ineligible for BadgerCare Plus.

If the individual does not apply for BadgerCare Plus, or applies after the end of the month following the month in which he or she was determined presumptively eligible, his or her PE period ends with no extension. Sending a negative notice is not necessary. If the individual applies after the end of the month following the month he or she was determined eligible, process the application as you would a standard BadgerCare Plus application.

*This page last updated in Release Number: 14-01
Release Date: 09/05/14
Effective Date:02/01/14*

[View History](#)

32.5 QUALIFIED HOSPITALS FOR PRESUMPTIVE ELIGIBILITY (PE)

Qualified hospitals are certified by ForwardHealth to make PE determinations. Qualified hospitals can make PE determinations for the following populations:

- Children
 - Pregnant women
 - Individuals applying for FPOS
 - Parents and caretakers
 - Childless adults
 - Women under age 65 with breast or cervical cancer

Only qualified hospitals are allowed to make PE determinations for parents, caretakers and childless adults. Other types of providers or partners are not allowed to make PE determinations for these populations.

32.6 Express Enrollment process in ACCESS

Qualified hospitals will be allowed to make PE determinations for patients who are inmates of public correctional institutions that are not state correctional facilities (e.g., county jails) as long as those patients are expected to remain in the hospital for 24 hours or more. The PE determination process for these patients will be the same as for other patients. Patients who are inmates of a state correctional facility are not eligible for Medicaid or BadgerCare Plus through the hospital PE process.

For the purposes of PE, a “hospital” is defined as an inpatient hospital facility or an outpatient hospital facility located within the four walls of an inpatient hospital facility, consistent with the definition of “hospital” for the purpose of billing Medicaid. These facilities are enrolled in Wisconsin Medicaid as Provider Type 01 or Provider Type 58.

Becoming a qualified hospital for PE is a straightforward process and there is no cost for this designation. Hospitals will be required to notify ForwardHealth of their interest in becoming a qualified hospital for PE via the ForwardHealth Portal: forwardhealth.wi.gov.

Qualified hospitals engaging in the PE process are subject to standards on assisting the patient with also submitting a BadgerCare Plus application for ongoing coverage after the PE period ends. For patients determined eligible for PE for FPOS, qualified hospitals are subject to standards on assisting the patient with submitting a BadgerCare Plus application or a FPOS application.

*This page last updated in Release Number: 14-03
Release Date: 09/05/14
Effective Date: 04/01/14*

[View History](#)

32.6 EXPRESS ENROLLMENT PROCESS IN ACCESS

Refer to [ACCESS Handbook](#) Chapter 12 for more information on determining presumptive eligibility for BadgerCare Plus using the Express Enrollment process in ACCESS.

*This page last updated in Release Number: 14-03
Release Date: 09/05/14
Effective Date: 09/28/14*

33 Estate Recovery

[View History](#)

33.1 ESTATE RECOVERY PROGRAM DEFINITION

The state seeks repayment of certain correctly paid home health and long-term care benefits received by BadgerCare Plus members by:

1. Liens against property after the death of a member,
2. Claims against estates, and
3. Affidavits.

A lien is never filed against the home of a BadgerCare Plus member during his or her lifetime, even if the member is living in a nursing home or institutionalized in an inpatient hospital.

*This page last updated in Release Number: 15-01
Release Date: 05/15/2015
Effective Date: 05/15/2015*

[View History](#)

33.2 RECOVERABLE SERVICES

Not all services provided by BadgerCare Plus are recoverable. Recoverability depends on what was provided and the member's age when he or she received the benefit.

The following are services for which ERP may seek recovery:

1. All BadgerCare Plus services received on or after age 55 while living in a nursing home
2. All BadgerCare Plus services received on or after age 55 while institutionalized in an inpatient hospital.
3. Home health care services received by members age 55 or older on or after July 1, 1995 consisting of:
 - a. Skilled nursing services.
 - b. Home health aide services.
 - c. Home health therapy and speech pathology services.
 - d. Private duty nursing services.
 - e. Personal care services received by members 55 or older on or after April 1, 2000.
4. All home and community-based waiver services Community Options Program (COP) Waiver, CIP 1A, CIP 1B, CIP II, Brain Injury Waiver, Community Opportunities and Recovery and Community Supported Living Arrangements received by members age 55 or older between July 1, 1995 and July 31, 2014 and:
 - a. Prescription/legend drugs received by waiver participants.
 - b. Benefits paid associated with a waiver participant's inpatient hospital stay.

These include inpatient services that are billed separately by providers and Services that are non-covered hospital services.

5. Family Care services received by members age 55 or older between February 1, 2000 and July 31, 2014 and:
 - a. Prescription/legend drugs received by waiver participants.
 - b. Benefits paid associated with a waiver participant's inpatient hospital stay. This includes inpatient services that are billed separately by providers and that are non-covered hospital services.
6. All Family Care Partnership services received by members age 55 and older while residing in a nursing home or while institutionalized in an inpatient hospital on or after March 1, 2009. All Family Care Partnership home and community-based waiver services, prescription/legend drugs and benefits associated with an inpatient hospital stay that are received by members age 55 or older between March 1, 2009 and July 31, 2014.
7. All Include, Respect, I, Self-Direct (IRIS) services, prescription/legend drugs and benefits associated with an inpatient hospital stay that are received by members age 55 or older before July 31, 2014.
8. All BadgerCare Plus services received by members age 55 or older participating in a long-term care program on or after August 1, 2014. Long-term care programs include all home and community-based waiver programs [including COP-W, CIP 1A, CIP 1B, CIP II, Brain Injury Waiver, Community Opportunities and Recovery, Community Supported Living Arrangements, FamilyCare, FamilyCare Partnership, IRIS and the Program of All-Inclusive Care for the Elderly (PACE)]. The capitation payment made to the Managed Care Organization on or after August 1, 2014 will be recovered for members receiving long-term care program services through managed care.

*This page last updated in Release Number: 15-01
Release Date: 05/15/2015
Effective Date: 05/15/2015*

[View History](#)

33.3 ESTATE CLAIMS

[33.3.1 Waiver of Estate Claim](#)

[33.3.2 Notice of Hardship Waiver Rights](#)

[33.3.3 Administrative Hearings: Hardship Waivers](#)

[33.3.4 Personal Representative's Report](#)

[33.3.5 Home as Part of the Estate](#)

[33.3.6 Affidavits in Small Sum Estates and Non-Probate Property](#)

[33.3.7 Patient Fund Account](#)

[33.3.8 Native Americans](#)

[33.3.9 Reparation Payments to Individuals](#)

33.3.10 Voluntary Recovery (ERP)

DHS recovers BadgerCare Plus benefit costs from the member's estate or from the member's surviving spouse's estate.

Recovery from a member's surviving spouse's estate will be limited to 50% of the marital property that the member had an interest in immediately prior to death.

When DHS learns of the death of a member or a member's surviving spouse, it files a claim in probate court in the amount of BadgerCare Plus recoverable benefits.

The probate court will not allow a claim on the estate to be paid if any of the following survives the member:

1. A spouse.
2. A child, if the child is:
 - a. Under age 21, or
 - b. Blind, or
 - c. Disabled.

Do not negotiate a settlement, accept any funds, or sign any release for estate claims that have been filed by DHS. *ERP* staff should be notified if a claim is filed by the county against an estate for recovery of overpayments or incorrect BadgerCare Plus benefits, for those 55 years of age or older.

Refer any questions about specific estate claims to the ERP staff.

33.3.1 Waiver of Estate Claim

An heir or beneficiary of the deceased member's estate or co-owner or beneficiary of a member's non-probate property may apply for a waiver of an estate claim filed by ERP. To be successful, the person applying for the waiver must show one of these three hardships exist:

1. The waiver applicant would become or remain eligible for AFDC, SSI , FoodShare or Medicaid if ERP pursued the estate claim.
2. The deceased member's real property is part of the waiver applicant's business (for example, a farm) and the ERP recovery claim would affect the property and result in the waiver applicant's loss of his or her means of livelihood.
3. The waiver applicant is receiving general relief or veteran's benefits based on need under §45.40(1m) Wis. Stats.

The waiver application must be made in writing within 45 days after the day:

1. ERP mailed its recovery claim to the probate court or its affidavit to the heir, beneficiary or co-owner or
2. ERP mailed its notice of waiver rights, whichever is latest.

The waiver application must include these points:

1. Relationship of the waiver applicant to the deceased member.
2. The hardship under which the waiver is requested.

ERP staff must issue a written decision granting or denying the waiver request within 90 days after the waiver application is received by ERP. In determining its decision, ERP must consider all information provided to it within 60 days of its receipt of the waiver application.

33.3.2 Notice of Hardship Waiver Rights

ERP will provide notice of the waiver provisions to the person handling the deceased member's estate. If ERP is not able to determine who that person is, the notice will be included with the claim when ERP files it with the claim court.

The person handling the estate is then responsible for notifying the decedent's heirs and beneficiaries of the waiver provisions.

ERP will provide notice of the waiver provisions to co-owners and beneficiaries of the member's non-probate property.

33.3.3 Administrative Hearings: Hardship Waivers

If a waiver application is denied, the waiver applicant may request an administrative hearing. ERP staff will attend the hearing to defend their denial of the hardship waiver.

The hearing request must be made within 45 days of the date the ERP decision was mailed.

The hearing request must:

1. Be made in writing.
2. Identify the basis for contesting the ERP decision.
3. Be made to the Division of Hearings and Appeals (DHA) at:

Department of Administration
Division of Hearings and Appeals
P.O. Box 7875

Madison, WI 53707-7875

The date the request is received at DHA is used to determine the timeliness of the request.

ERP staff will maintain DHS' claim in the estate pending the administrative hearing decision. If collections are made and the waiver is ultimately approved, those funds will be returned.

To introduce evidence at a hearing not previously provided to DHS, the applicant must mail that evidence to DHS with a postmark at least seven working days before the hearing date.

33.3.4 Personal Representative's Notice

The personal representative of the estate of a BadgerCare Plus member or the estate of a member's surviving spouse must notify DHS that the estate is being probated [§859.07(2), Wis. Stats.]. The notification must be by certified mail and include the date by which claims against the estate must be filed.

33.3.5 Real Property as Part of the Estate

When real property is part of the estate, ERP may file a lien equal to the BadgerCare Plus payments even if one of these persons is alive:

1. The spouse.
2. A child under age 21.
3. A disabled or blind child of any age.

Recovery through the lien will not be enforced as long as any of these persons meet the criteria and is alive.

Example 1: Mr. A dies. A claim on his estate is filed and the estate includes real property. His spouse is deceased and he has no blind or disabled child. He has a child, age 19. This child lives outside Mr. A's home. A lien is placed on the real property but cannot be enforced because the minor child is still alive. The child later turns 21. As there is then no living spouse, child under 21, or disabled or blind child, the lien can be enforced.

DHS will take a lien in full or partial settlement of an estate claim against the portion of an estate that is a home if:

1. A child, of any age of the deceased member:
 - a. Resides in the member's home, **and**

- b. That child resided in that home for at least 24 months before the member entered the nursing home, hospital, or received home and community-based waiver services, **and**
 - c. That child provided care that delayed the member's move to the nursing home, hospital, or his or her receipt of home and community-based waiver services.
2. A sibling of the deceased member:
 - a. Resides in the member's home, **and**
 - b. Resided in that home for at least 12 months before the date the member entered a nursing home, hospital, or received home and community-based services.

The lien filed in one of these two instances will be payable at the death of the caretaker child or sibling or when the property is transferred, whichever comes first.

However, if the caretaker child or sibling sells the home covered by the DHS lien, and uses the sale proceeds to buy another home to be used as that child's or sibling's primary residence, then:

1. DHS will transfer the lien to the new home if the amount of the caretaker child or sibling's payment or down payment for the new home is equal to or greater than the proceeds from the original home.
2. If the down payment on the new home is less than the proceeds from the sale of the original home, DHS will recover the amount of the proceeds above the down payment, but no greater than the lien amount. If there is an amount in the lien still not satisfied, DHS will file a lien for the remaining amount on the new home.

33.3.6 Affidavits in Small Sum Estates and Non-Probate Property

Heirs, guardians and trustees of revocable trusts created by a deceased BADGERCARE PLUS member must notify ERP before transferring any of the deceased's property through a Transfer by Affidavit (\$50,000 and under) (§867.03, Wis. Stats.). The heir, guardian or trustee must send a copy of the affidavit to ERP by certified mail, return receipt requested. Examples of property include bank accounts (savings or checking); postal savings; credit union or building and loan shares; contents of safe deposit boxes; savings bonds; stocks and other securities; promissory notes and mortgages which are payable to the applicant/recipient and negotiable; real estate; etc.

If an heir, guardian or trustee transfers the deceased's property, ERP will send an affidavit to the heir, guardian or trustee to recover any funds remaining after burial and estate administration costs have been paid. Funeral costs are limited to those expenses connected with the funeral service and burial. A marker for the grave is considered a burial cost. Memorials and/or donations to churches, organizations, persons, or institutions are not considered burial costs.

ERP will also send its affidavit to the co-owners and/or beneficiaries of a member's non-probate property. Non-probate property is property that passes outside an individual's estate. This means that non-probate property does not go through probate before it is transferred to those who inherit it. Non-probate property subject to recovery includes, but is not limited to, life estates, property held in joint tenancy, life insurance proceeds, property held in revocable trusts, and property that is payable-on-death or transfer-on-death to a beneficiary.

Co-owners and beneficiaries of a member's non-probate property have the right to request a fair hearing as on the value of the member's interest in the property.

The value of the member's interest for jointly owned property is the percentage interest attributed to the member when Medicaid eligibility was determined or, if not determined at eligibility, the fractional interest the member had in the property at his or her death. For life estate interests, the value is the percentage of ownership based on the member's age at the date of death, according to the life estate tables used for Medicaid eligibility.

The value of the property is the fair market value. Fair market value is the price a willing buyer would pay to a willing seller for purchase of the property. It is the co-owners' or beneficiaries' responsibility to establish that value through a credible method like an appraisal by a licensed appraiser.

ERP staff will attend the fair hearing to present DHS' position on the value of the property.

Real property of a BadgerCare Plus member, whether non-probate or transferred by affidavit, is subject to a lien if the state's claim cannot be satisfied through other assets.

DHS may not enforce the lien while any of the following survive:

1. Spouse,
2. Child who is:
 - a. Under age 21, or
 - b. Blind, or
 - c. Disabled.

ERP will recover any funds that remain from a burial trust after costs have been paid.

Direct specific questions about questionable allowable costs to ERP staff.

33.3.7 Patient Fund Account

Nursing homes are required to notify ERP when a BadgerCare Plus member dies with money left in his or her nursing home patient fund account if he or she has no surviving spouse or minor or disabled child.

ERP will claim from the nursing home any funds remaining in the patient account after payment of funeral and burial expenses and outstanding debts from the last month of illness that are not chargeable to BadgerCare Plus.

33.3.8 Native Americans

Native Americans: Income, Resources and Property Exempt from BadgerCare Plus Estate Recovery

The following income, resources, and property are exempt from BadgerCare Plus estate recovery:

1. Certain income and resources (such as interests in and income derived from Tribal land and other resources currently held in trust status and judgment funds from the Indian Claims Commission and the U.S. Claims Court) that are exempt from BadgerCare Plus estate recovery by other laws and regulations;
2. Ownership interest in trust or non-trust property, including real property and improvements:
 - a. Located on a reservation (any federally recognized Indian Tribe's reservation, Pueblo, or Colony, including former reservations in Oklahoma, Alaska Native regions established by Alaska Native Claims Settlement Act and Indian allotments) or near a reservation as designated and approved by the Bureau of Indian Affairs of the U.S. Department of the Interior; or
 - b. For any federally -recognized Tribe not described in (a), located within the most recent boundaries of a prior Federal reservation.
 - c. Protection of non-trust property described in (a) and (b) is limited to circumstances when it passes from an Indian (as defined in section 4 of the Indian Health Care Improvement Act) to one or more relatives (by blood, adoption, or marriage), including Indians not enrolled as members of a Tribe and non-Indians, such as spouses and step-children, that their culture would nevertheless protect as family members; to a Tribe or Tribal organization; and/or to one or more Indians;
3. Income left as a remainder in an estate derived from property protected in 2 above, that was either collected by an Indian, or by a Tribe or Tribal organization and distributed to Indian(s), as long as the individual can clearly trace it as coming from the protected property.
4. Ownership interests left as a remainder in an estate in rents, leases, royalties, or usage rights related to natural resources (including extraction of natural resources or harvesting of timber, other plants and plant products, animals, fish, and shellfish) resulting from the exercise of Federally-protected rights, and income either collected by an Indian, or by a Tribe or Tribal organization and

distributed to Indian(s) derived from these sources as long as the individual can clearly trace it as coming from protected sources; and

5. Ownership interests in or usage rights to items not covered by 1-4 above that have unique religious, spiritual, traditional, and/or cultural significance or rights that support subsistence or a traditional life style according to applicable Tribal law or custom

Native Americans: Income, Resources and Property Not Exempt from BadgerCare Plus Estate Recovery

The following income, resources and property from the estates of Native Americans are not exempt from estate recovery:

1. Ownership interests in assets and property, both real and personal, that are not described in items 1-5 above.
2. Any income and assets left as a remainder in an estate that do not derive from protected property or sources in items 1-5.

33.3.9 Reparation Payments to Individuals

Government reparation payments to special populations are exempt from BadgerCare Plus estate recovery.

33.3.10 Voluntary Recovery (ERP)

When a member age 55 or older wishes to pay an amount to Medicaid to maintain Medicaid eligibility, prepay a Medicaid deductible, or reduce a potential claim in an estate, forward the payment to ERP. First check, BVCI to make sure there is not an outstanding Medicaid claim for an overpayment since the money should be applied to an overpayment first. Voluntary payments, except for prepayment of a deductible may only be up to the amount of Medicaid paid to date.

The check or money order should be made payable to DHS.

Mail the payment to:

Estate Recovery
313 Blettner Blvd
Madison WI
53714-2405

With the payment, include:

1. Documentation that the payment is voluntary.
2. The member's name and Medicaid ID number.

3. Name and address of the person who should receive the receipt.

These refunds will be credited to the member and will be used to offset any claim that may be filed in the member's estate.

Incentive payments of 5% will be paid to the IM Agency for refunds.

Advise heirs and beneficiaries of deceased members who wish to make a voluntary refund to call ERP staff.

*This page last updated in Release Number: 15-01
Release Date: 05/15/2015
Effective Date: 05/15/2015*

[View History](#)

33.4 MATCH SYSTEM

ERP maintains the Estate Recovery Database. Information you submit on the Estate Recovery Disclosure Form is on the database.

The database is compared to the death record files of the Division of Health Care Access and Accountability, Vital Records and State Registrar Section.

When a match shows a BadgerCare Plus member or his or her surviving spouse has died, a report record is produced. ERP staff checks the report against new probate proceedings listed on the Wisconsin Circuit Court Access website. This is a back up to the requirement that DHS be notified of the last date for filing claims.

*This page last updated in Release Number: 15-01
Release Date: 05/15/2015
Effective Date: 05/15/2015*

[View History](#)

33.5 NOTIFY MEMBERS

Provide a copy of the Wisconsin Estate Recovery Program Handbook (P-13032) to every BadgerCare Plus member 54 1/2 years old or older at application and review.

Have each member or his or her representative read the notice of liability on the application form ("Recovery of BadgerCare Plus"). He or she acknowledges understanding of this notice when signing the application.

*This page last updated in Release Number: 15-01
Release Date: 05/15/2015
Effective Date: 05/15/2015*

[View History](#)

33.6 DISCLOSURE FORM

Complete an Estate Recovery Program Disclosure Form whenever a BadgerCare Plus member becomes 55 years old.

Do this even if he or she has zero assets.

Complete the form with information about the member, his or her spouse, and his or her children that are blind, disabled, or under age 21.

Attach a legible copy of the latest property tax bill or a copy of the property deed for any real property reported if possible. This may give ERP staff the property's legal description needed to file a lien.

Attach a legible copy of any documents relating to trusts created by the member or the member's spouse.

Request the member or his or her agent to sign the completed form. If he or she will not sign the form:

1. Sign the form at the "Member Signature" line.
2. Note near your signature that you reviewed the data with the person or his or her agent. Indicate:
 - a. That he or she did or did not agree the data was accurate.
 - b. The reason he or she did not sign.

In a mail-in application situation, document if the form was not returned or was returned without a signature.

Send the completed form to the ERP. File a copy in the case record.

You need not update this form unless there is a substantial change in circumstances (for example, an inheritance).

*This page last updated in Release Number: 15-01
Release Date: 05/15/2015
Effective Date: 05/15/2015*

[View History](#)

33.7 ESTATE RECOVERY PROGRAM (ERP)

The ERP address is:

Estate Recovery Program Section
Division of Health Care Access and Accountability
P.O. Box 309
Madison, WI 53701-0309

For general information regarding ERP, refer members to Member Services at 1-800-362-3002.

Direct case-specific questions about:

1. Estate recovery disclosure forms and liens to the Estate Recovery Specialist, (608) 264-6755.
2. For small estates of \$50,000 or less, provide the phone number of the "Affidavit Help Line," (608) 264-6756, to heirs of deceased members who have questions about ERP. The Help Line provides recorded messages that answer the most frequently asked questions regarding small sum estates. It also provides the caller with an opportunity to either leave a message or talk to ERP staff.
3. Tribal inquiries should be re-directed to the ERP Section Chief, (608) 261-7831.

*This page last updated in Release Number: 15-01
Release Date: 05/15/2015
Effective Date: 05/15/2015*

[View History](#)

33.8 INCENTIVE PAYMENTS

DHS will return to local agencies 5% of collections made through a lien, voluntary payments and probated estate recoveries. We will pay this incentive to the last agency certifying the member for BadgerCare Plus.

The payments are discretionary. DHS will make them based on compliance with program requirements.

*This page last updated in Release Number: 15-01
Release Date: 05/15/2015
Effective Date: 05/15/2015*

[View History](#)

33.9 OTHER PROGRAMS

ERP also recovers for Medicaid, the Community Options Program (COP), Wisconsin Chronic Disease Program (WCDP), Medicaid and non-Medicaid Family Care.

*This page last updated in Release Number: 15-01
Release Date: 05/15/2015
Effective Date: 05/15/2015*

34-37 Reserved

RESERVED

PROGRAM COVERAGE (CHAPTERS 38-47)

38 Covered Services

[View History](#)

38.1 COVERED SERVICES

A covered service is any health care service that BadgerCare Plus will pay for an eligible member, if billed. The Division of Health Care Access and Accountability (DHCAA) enrolls qualified health care providers and reimburses them for providing BadgerCare Plus covered services to eligible BadgerCare Plus members. Members may receive BadgerCare Plus services only from enrolled providers, except in medical emergencies. BadgerCare Plus reimburses emergency medical services necessary to prevent the death or serious impairment of the health of a member even when provided by a non-enrolled provider.

*this page last updated in Release Number: 13-02
Release Date: 10/25/13
Effective Date: 10/01/13*

[View History](#)

38.2 STANDARD PLAN

[38.2.1 Introduction](#)

[38.2.2 Copayment](#)

38.2.1 Introduction

Effective April 1, 2014, all BadgerCare Plus members are covered under the Standard Plan. The following chart shows some of the covered services and co-payments under the Standard Plan.

Services	BadgerCare Plus Standard Plan
Chiropractic Services	Full coverage. Co-payment \$.50 to \$3 per service (varies by service provided).
Dental	Full coverage of preventive, restorative and palliative services.

	Co-payment \$.50 to \$3 per service (varies by service provided).
Disposable Medical Supplies (DMS)	Full coverage. Co-payment \$0.50 to \$3.00 per service.
Drugs (See also 38.7 Impact on Dual Eligible Individuals)	Comprehensive drug benefit with coverage of generic and brand name prescription drugs and some over-the-counter (OTC) drugs. Members are limited to 5 prescriptions per month for opioid drugs. Co-payments: \$0.50 for OTC Drugs \$1.00 for Generic Drugs \$3.00 for Brand Name Drugs Co-payments are limited to \$12.00 per member, per provider, per month. OTCs are excluded from this \$12.00 maximum.
Durable Medical Equipment (DME)	Full coverage. Co-payment \$0.50 to \$3.00 per item (varies by item provided). Rental items are not subject to a co-payment.
Health Screenings for Children	Full coverage of Health Check screenings and other services for individuals under age 21 years. Co-payment \$1 per screening for those 18, 19 and 20 years of age.
Hearing Services	Full coverage. Co-payment \$.50 to \$3 per procedure. No co-payments for hearing aid batteries.
Home Care Services (home health, private duty nursing and personal care)	Full coverage. No co-payment.
Hospice	Full coverage. No co-payment.
Hospital - Inpatient	Full coverage.

	<p>Co-payment \$3 per day with a \$75 cap per stay.</p>
Hospital - Outpatient	<p>Full coverage.</p> <p>Co-payment \$3 per visit.</p>
Hospital - Outpatient Emergency Room	<p>Full coverage.</p> <p>No co-payment.</p>
Mental Health and Substance Abuse Treatment	<p>Full coverage (not including room and board).</p> <p>Co-payment \$.50 to \$3 per visit (limited to the first 15 hours or \$500 of services, whichever comes first, provided per calendar year).</p> <p>Co-payment not required when services are provided in a hospital setting.</p>
Nursing Home	<p>Full coverage.</p> <p>No co-payment.</p>
Physical Therapy (PT), Occupational Therapy (OT) and Speech Therapy (ST)	<p>Full coverage.</p> <p>Co-payment \$.50 to \$3 per provider, per date of service.</p> <p>Co-payment obligation is limited to the first 30 hours or \$1,500 whichever occurs first, during one calendar year (co-payment limits are calculated separately for each discipline.)</p>
Physician Visits	<p>Full coverage, including laboratory and radiology.</p> <p>Co-payment \$.50 to \$3 co-payment per service (varies by service provided).</p> <p>Limited to \$30 per provider per calendar year.</p> <p>No co-payment for emergency services, anesthesia or clozapine management.</p>
Podiatric Services	<p>Full coverage.</p> <p>Co-payment \$.50 to \$3 per service.</p>
Prenatal/Maternity Care	<p>Full coverage, including prenatal care coordination and preventive mental health and substance abuse screening and counseling for pregnant women at risk of mental health or substance abuse problems.</p>

	No co-payment.
Reproductive Health Services	Full coverage, excluding infertility treatments, surrogate parenting and related services, including but not limited to artificial insemination, and subsequent obstetrical care as a non covered service, and the reversal of voluntary sterilization. No co-payment for family planning services.
Routine Vision	Full coverage including coverage of eye glasses. Co-payment \$.50 to \$3 per service (varies by service provided).
Smoking Cessation Services	Coverage includes prescription and over-the-counter tobacco cessation products. Co-payment (see drugs)
Transportation	Full coverage of emergency and non-emergency transportation to and from a certified provider for a BadgerCare Plus covered service. Co-payments are: <ul style="list-style-type: none"> • \$2 for non-emergency ambulance trips. • \$1 per trip for transportation by an SMV. No co-payment for transportation by common carrier or emergency ambulance.

If you or the member has additional questions, contact Member Services at 1-800-362-3002.

38.2.2 Copayment

A BadgerCare Plus member may be required to pay a part of the cost of a service. This payment is called a "co-payment" or "co-pay".

Through March 31, 2014, the co-payment policy is as follows:

Exempt from Co-payments

- Children under age 19 with family income up to 100% of the FPL.
- Children under age 6 with family income above 100% up to 150% of the FPL, except for Continuously Eligible Newborns.
- Children ages 1 through 5 who are Tribal members with family income from 185% to 300% of the FPL.

- Children ages 6 through 18 who are Tribal members with family income from 150% to 300% of the FPL.
- Children under age 19 eligible through Express Enrollment.
- Children under age 19 in an institution.
- Children under age 19 eligible under a BadgerCare Plus Extension
- Pregnant women, except for pregnant girls under age 19 with family incomes above 300% of the FPL.
- Pregnant women eligible through Express Enrollment.
- Pregnant women eligible for the prenatal benefit.

Standard Plan - Nominal Co-payments

- Continuously Eligible Newborns with family incomes above 100% up to 200% of poverty.
- Children under age 6 with family income above 150% up to 200% of poverty.
- Children ages 6 through 18, with family income above 100% up to 200% of poverty.
- Children under age 19 with family income above 150% of poverty who have met a deductible.
- Parents and caretakers up to 200% of poverty.
- Parents and caretakers in BadgerCare Plus Extensions.
- Youths Exiting Out-of-Home Care.
- Transitional Grandfathered parents and caretakers.

Members covered under the Standard plan will have co-payments ranging from \$0.50 to \$3.00. Providers are required to make a reasonable effort to collect the co-payment but may not refuse services to a member who fails to make that payment.

Effective April 1, 2014, the co-payment policy is as follows:

Providers are prohibited from collecting co-payment from the following members:

- Children in a mandatory coverage category. In Wisconsin, this includes:
 - Children in foster care, regardless of age.
 - Children in adoption assistance, regardless of age.
 - Children under age one with income up to 150 percent of the FPL.
 - Children ages 1 through 5 with income up to 185 percent of the FPL.
 - Children ages 6 through 18 years of age with incomes at or below 133 percent of the FPL.
- Children in the Katie Beckett program, regardless of age.
- Children under 19 eligible through Express Enrollment.

- Children who are American Indian or Alaska Natives who are enrolled in the state's CHIP.
 - American Indians or Alaskan Natives, regardless of age or income level, when they receive items and services either directly from an Indian health care provider or through referral under contract health services.
 - Terminally ill individuals receiving hospice care.
 - Nursing home residents.
 - Women enrolled in Wisconsin Well Woman Medicaid.

The following services do not require co-payment:

- Case management services.
 - Crisis intervention services.
 - Community support program services.
 - Emergency services.
 - Family planning services, including sterilizations.
 - HealthCheck.
 - HealthCheck "Other Services."
 - Home care services.
 - Hospice care services.
 - Immunizations.
 - Independent laboratory services.
 - Injections.
 - PDN and PDN services for ventilator-dependent members.
 - Pregnancy related services.
 - Preventive services with an A or B rating from the U.S. Preventive Services Task Force.
 - School-based services.
 - Substance abuse day treatment services.
 - Surgical assistance.

*this page last updated in Release Number: 14-02
Release Date: 05/14/14
Effective Date: 04/01/14*

[View History](#)

38.3 TRANSPORTATION

[38.3.1 Ambulance](#)

[38.3.2 Specialized Medical Vehicle \(SMV\)](#)

[38.3.3 Common Carrier](#)

[38.3.4 Transportation Coordination](#)

Federal regulations require the Medicaid program provide transportation for members who have no other way to receive a ride to their Medicaid health care appointments. Transportation can be by ambulance, specialized medical vehicle (SMV) or common carrier.

38.3.1 Ambulance

Ambulance transportation is a covered service, if it is provided by a BadgerCare Plus certified ambulance provider, and the member is suffering from an illness or injury that rules out other forms of transportation, and only if it is for:

1. Emergency care when immediate medical treatment or examination is needed to deal with or guard against a worsening of the person's condition.
2. Non-emergency transportation when use of any other method of transportation is contraindicated and is authorized in writing by a physician, physician assistant, nurse midwife, nurse practitioner, or registered nurse.

38.3.2 Specialized Medical Vehicle (SMV)

An SMV is a vehicle equipped with a lift or ramp for loading wheelchairs. The driver of an SMV must meet driver requirements in accordance with [DHS 105.39 Wis. Admin Code](#).

SMV transportation is a covered service if provided by a BadgerCare Plus SMV enrolled provider and a health care provider has documented why the member's condition prevents him or her from using a common carrier or private vehicle

38.3.3 Common Carrier

Common carrier means any mode of transportation other than an ambulance or an SMV.

38.3.4 Transportation Coordination

Non-emergency Medical Transportation (NEMT) is coordinated by Department of Health Services' NEMT manager, Medical Transportation Management, Inc. (MTM Inc.). As the NEMT manager, MTM Inc. arranges and pays for rides to covered Medicaid services for members who have no other way to receive a ride. Rides can include ambulance, SMV or common carrier transportation depending on a member's medical and transportation needs.

The NEMT manager does not coordinate transportation for the following members:

- Members who are residing in a nursing home.
 - Members residing in a nursing home have their NEMT services coordinated by the nursing home.

- Members who are enrolled in Family Care.
 - Members enrolled in Family Care receive NEMT services from the Family Care Managed Care Organization (MCO).

*this page last updated in Release Number: 13-02
Release Date: 10/25/13
Effective Date: 10/01/13*

[View History](#)

38.4 HMO ENROLLMENT

[38.4.1 Change of Circumstances](#)

[38.4.2 Disenrollment](#)

[38.4.3 Fiscal Agent Ombuds](#)

Most BadgerCare Plus members who are eligible for BadgerCare Plus and reside in a BadgerCare Plus HMO service area must enroll in an HMO.

Members may choose their own HMO or work with the HMO Enrollment Specialist to choose the best one for their needs. They may choose at any time during the enrollment process. All eligible members of the member's family must choose the same HMO. However, individuals within a family may be eligible for an exemption from enrollment.

This is the enrollment process:

1. Members residing in an HMO service area receive an HMO enrollment packet. The packet has an enrollment form, a list of available HMOs, instructions on how to choose an HMO and how to find out if a provider is affiliated with an HMO.

2. If the member lives in an area covered by two or more HMOs, enrollment is mandatory. In areas with only one available HMO, enrollment is voluntary and the process stops here.

3. If the member lives in a mandatory area and does not choose an HMO, he or she will be assigned an HMO. A letter explaining the assignment will be sent to him or her. He or she will receive another enrollment form and have an opportunity to change the assigned HMO.
4. He or she will then receive a notice confirming enrollment in the assigned or chosen HMO for the following month. The member has up to three months to change HMOs, once enrolled. This is the open enrollment period. After the initial three months, the member is locked into the HMO and cannot change for nine months. If your member has questions about HMO enrollment, he or she should contact the Enrollment Specialist at 1-800-291-2002.

Exemptions: A member may qualify for an exemption from HMO enrollment if he or she meets certain criteria, such as a chronic illness, high-risk third trimester pregnancy, or continuity of care concerns, etc.

If the member believes he or she has a valid reason for exemption, he or she should call the HMO Enrollment Specialist at 1-800-291-2002. The number is also in the enrollment materials he or she receives.

38.4.1 Change of Circumstances

Members who lose BadgerCare Plus eligibility, but become eligible again may be automatically re-enrolled in their previous HMO.

If the member's eligibility is re-established after a Restrictive Re-enrollment Period (*RRP*), he or she will be automatically re-enrolled in the previous HMO, unless the HMO is no longer accepting reassignments.

After six months, or if the HMO is no longer accepting reassignments or has exceeded its enrollment level, he or she will receive an enrollment packet, and the enrollment process will start over.

38.4.2 Disenrollment

Members are automatically disenrolled from the HMO program if:

1. Their medical status code changes to a BadgerCare Plus subprogram that does not require enrollment in an HMO.
2. They become eligible for Medicare.
3. They lose eligibility.
4. They move out of the HMO's service area.

Members can be disenrolled by the HMO's request in the following situations:

1. They become inmates of a public institution.
2. They need an experimental transplant.

Note: HMO disenrollment is not automatic in these situations.

Members who move out of the HMO service area receive a new packet showing the HMO(s) available in the new area and the enrollment process begins again. If no HMO covers the member's new area, he or she remains fee-for-service.

38.4.3 Fiscal Agent Ombuds

Members with questions about their rights as HMO members may call 1-800-760-0001 or write:

HMO Ombudsman
P.O. Box 6470
Madison, WI 53791-9823

*this page last updated in Release Number: 13-02
Release Date: 10/25/13
Effective Date: 10/01/13*

[View History](#)

38.5 BADGERCARE PLUS CARDS

[38.5.1 BadgerCare Plus Cards Introduction](#)

[38.5.1.1 BadgerCare Plus & Medicaid Card Image](#)

[38.5.1.2 SeniorCare Card Image](#)

[38.5.1.3 Wisconsin Well Woman Program Card Image](#)

[38.5.2 Appeals](#)

[38.5.3 Homeless](#)

[38.5.4 Pharmacy Services Lock-in Program](#)

[38.5.5 Temporary Cards](#)

[38.5.6. Lost-Stolen Cards](#)

38.5.1 BadgerCare Plus Cards Introduction

All BadgerCare Plus members are issued ForwardHealth cards. These cards are plastic and display the words: **ForwardHealth**.

Note: Members who were previously enrolled in the BadgerCare Core Plan or the BadgerCare Plus Basic Plan received cards with the program names listed. These programs ended on March 31, 2014.

Members use the same ForwardHealth card each month to receive services on a fee for service basis and/or through a managed care organization, if enrolled. Monthly cards are not issued.

Each person in the family who is eligible receives his or her own card for the Benefit Plan for which they are eligible. Members may have multiple ID cards if they have been in one or more of the plans listed above.

The cards do not display eligibility dates. Health care providers use the ID number on the front of the card to bill for services provided to the member.

Members will know if they are eligible, and for which Benefit Plan, based on positive and negative notices sent from the IM agency. They will also receive separate notices if enrolled in a Managed Care Organization. Members who receive a notice that they are no longer eligible for BadgerCare Plus should keep their ForwardHealth cards. Cards should not be thrown away. If a member becomes eligible again, he or she will use the same ForwardHealth card originally issued. If members have questions regarding their eligibility status, they can log into [ACCESS](#)> Change My Benefits or call Member Services at 1-800-362-3002.

38.5.1.1 BadgerCare Plus & Medicaid Card Image



38.5.1.2 SeniorCare Card Image

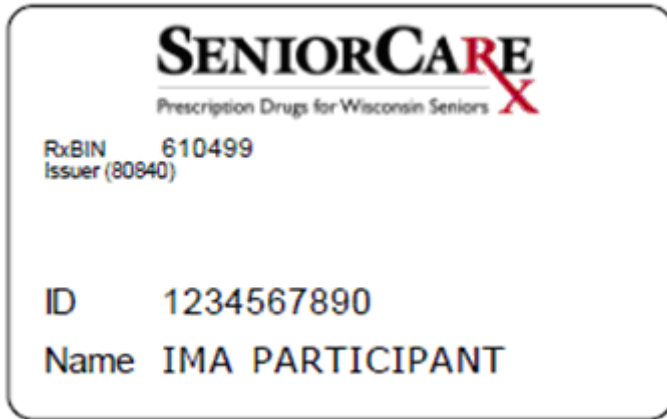

38.5.1.3 Wisconsin Well Woman Program Card Image



38.5.2 Appeals

Keep a BadgerCare Plus case in appeal status open if the member makes a request prior to the closure date. The member can continue to use his or her ForwardHealth card until a decision is made regarding his or her eligibility.

38.5.3 Homeless

Make ID cards available to homeless BadgerCare Plus members who have no fixed address or mailing address. Use your agency address or some other fixed address for delivery.

38.5.4 Pharmacy Services Lock-in Program

Members enrolled in the Pharmacy Services Lock-In Program are assigned to one primary care provider and one pharmacy to reduce unnecessary physician and pharmacy utilization and to discourage the non-medical or excessive use of prescription drugs. The Pharmacy Services Lock-In program applies to members in fee-for-service as well as members enrolled in Medicaid SSI HMOs and BadgerCare Plus HMOs. Members remain enrolled in the Pharmacy Services Lock-In Program for two years and are continuously monitored for their prescription drug usage. At the end of the two-year enrollment period, an assessment is made to determine if the member should continue enrollment in the Pharmacy Services Lock-In Program.

The Pharmacy Services Lock-In Program monitors claims for pharmacy services and prescription drugs specifically. The Pharmacy Services Lock-In Program does not address other types of member fraud or misuse of benefits, such as misuse of the ForwardHealth identification card or excessive use of emergency room services.

If a provider suspects that a member is abusing his or her benefits or misusing his or her ForwardHealth card, providers are required to notify ForwardHealth by calling Provider Services at (800) 947-9627 or by writing to the following office:

Wisconsin Division of Health Care Access and Accountability
Bureau of Program Integrity
PO Box 309
Madison WI 53701-0309

38.5.5 Temporary Cards

With implementation of the ForwardHealth ID card, temporary ID cards are no longer used or available for ordering from HP.

38.5.6. Lost-Stolen Cards

If a member needs a replacement card, he or she or an *authorized representative*, can request a replacement card by:

1. Going to [ACCESS](#)
 - Create a [MyACCESS Account](#), then
 - Go to your [MyACCESS Page](#) and select a new ForwardHealth Card, or
2. Contacting Member Services at 1-800-362-3002.

Workers may also log into the [Partner Portal](#) and select "Replacement ID Card Request" under

the Quick Links on the right side of the page.

If the member has multiple benefit ID cards, there will be a choice of which ID card to request.

A new ForwardHealth card will be created the evening of the request and will be sent out the following business day.

Replacement cards are issued automatically when the card has been returned as undeliverable and the member's address changes.

You cannot request replacement cards using a F-10110 (formerly DES 3070) or CARES.

This page last updated in Release Number: 11-01

Release Date: 03/29/11

Effective Date: 03/29/11

[View History](#)

38.6 GOOD FAITH CLAIMS

[38.6.1 Definition of Good Faith Claims](#)

[38.6.2 Denials](#)

[38.6.3 Causes and Resolutions](#)

[38.6.4 Process](#)

[38.6.5 Instructions](#)

38.6.1 Definition of Good Faith Claims

A Good Faith claim is a claim that has been denied by BadgerCare Plus with an eligibility-related Explanation of Benefits (EOB) code. This occurs even though the provider verified eligibility for the dates of service billed and submitted a correct and complete claim. Providers can resubmit the claim to HP Enterprise Services to be processed as a Good Faith claim. If the eligibility file has been updated by the time the claim is resubmitted, it will be paid automatically. If the file still does not reflect eligibility for the period covered by the claim, HP Enterprise Services will try to resolve the eligibility discrepancy. If they are unable to resolve it from the information available, they will contact the IM agency to verify eligibility. The Good Faith form ([F-10111](#)) is used for this purpose. A Good Faith claim cannot be reimbursed until the HP Enterprise Services member file is updated.

38.6.2 Denials

If a provider receives a claim denial for one of the following reasons on the Remittance Advice, the provider can resubmit it as a Good Faith claim

R/A Report Denial Code	Reason
029	Medicaid number doesn't match recipient's last name.
172	Recipient Medicaid ID number not eligible for dates of service.
281	Recipient Medicaid ID number is incorrect. Verify and correct the Medicaid number and resubmit claim.
614	Medicaid number doesn't match recipient's first name.

38.6.3 Causes and Resolutions

Causes and a Good Faith claim can occur when:

1. A member presents an ID card that is invalid because:
 - a. You issued a temporary ID card for a prior period or manually determined case and didn't update [CARES](#) or send HP Enterprise Services an F-10110 (formerly DES 3070) to update the member's eligibility file. HP Enterprise Services will apply the dates of eligibility indicated on the card with med stat 71. A letter will be sent to you to confirm that the member is eligible for the dates on the card. The letter will include instructions on how to complete an [F-10111](#) and the information that is needed.
 - b. The provider suspects the member of misusing or abusing a ForwardHealth card (i.e. using an altered card or a card that belongs to someone else). If the provider submits a copy of the card and HP Enterprise Services can tell that it was altered, HP Enterprise Services will contact you to verify that the member was eligible or forward it to the Division of Health Care Access and Accountability (DHCAA) for review.

2. The member's name has changed since the card was issued. HP Enterprise Services can usually resolve claims that are denied with code "029" and "614". If necessary, HP Enterprise Services will contact you to confirm the information.

With the implementation of the ForwardHealth cards, providers are less likely to receive one of the eligibility-related denials used for Good Faith claims submission. Providers are told to verify eligibility using the variety of methods available to them through the Eligibility Verification System (EVS). When the provider verifies the member's eligibility, they are getting the most current information available on the ForwardHealth interChange. Therefore, it is unlikely that they will be told the member is eligible when he or she is not.

The most likely reason a Good Faith situation arises is when a provider sees a temporary paper ID card issued by the agency. The provider may bill BadgerCare Plus before the eligibility is updated on ForwardHealth interChange, or perhaps the eligibility was never sent to ForwardHealth interChange. In either case, if the member presents a valid temporary BadgerCare Plus ID card for the dates of service, and the provider sends a copy of the card with

the Good Faith claim, HP Enterprise Services will update the member's eligibility file with a good faith segment and pay the claim immediately.

HP Enterprise Services will then attempt to resolve the discrepancy from information on file or contact you to confirm eligibility and correct the eligibility segment. If the provider doesn't send a copy of the ID card with the claim, HP Enterprise Services must confirm eligibility with you before the claim can be paid.

The definition of a 'valid' card is either a:

1. Forward card that indicates eligibility for the dates of service through the EVS.
2. A temporary paper card showing dates of eligibility.

38.6.4 Process

HP Enterprise Services initiate claim process by sending you a Good Faith form ([F-10111](#)) that they have partially completed, and one or two letters, depending on what documentation of eligibility the provider included with their claim. Complete the [F-10111](#) form if this is a new member (cert. 1) or return a new F-10110 (formerly DES 3070) for amended certifications (cert. 3). Send completed [F-10111](#) forms to:

Forward Health iChange
P.O. Box 7636
Madison, WI 53707-7636
Fax: (608) 221-8815

Send completed 3070 forms by:

1. Mail: HP Enterprise Services
P.O. Box 7636
Madison, WI 53707

2. Fax: (608) 221-8815

38.6.5 Instructions

Agency Denial

If the member identified on the Good Faith form was neither eligible nor possessed a valid ID card for the dates of service indicated in field six, place an "X" in this box. If you check "Yes" here, you must also check the reason in the field below.

Recipient Did Not Have ID Card After Date of Service

Place an "X" in this box if you are certain that the member did not possess a valid ID card for the date of service. In the blank provided, enter the closing date of eligibility.

Recipient Not Eligible

Place an "X" in this box if the member was not eligible for any of the dates of service shown. If the member was eligible for some of the dates of service, follow the instructions for completing the Partial Deny box.

Record Not Found

Place an "X" in this box if the member has never been eligible for BadgerCare Plus in your agency.

Dates of Services

HP Enterprise Services enters the dates of service for the claim.

Partial Deny

Use this field only if the member had eligibility for some of the dates of service. Enter the "from" and "to" dates which cover the portion of the dates of service for which the member did not have eligibility.

Type of Certification

HP Enterprise Services will check one of these boxes:

1. Initial Certification

HP Enterprise Services will place an "X" in this box when the member and BadgerCare Plus ID number submitted on the claim cannot be found on the eligibility master file.

2. Amended Certification

HP Enterprise Services will place an "X" in this box when the member is on interChange, but no eligibility exists for the claimed dates of service.

Agency Number

HP Enterprise Services will enter the three-digit code of the agency they believe may have certified the member during the dates in question.

Casehead ID Number

HP Enterprise Services will enter the known or suspected interChange case number (primary person's **SSN** + tie-breaker) of the member listed on the provider's claim.

Action Date

HP Enterprise Services enters the date they completed the Good Faith form.

Medical Status Code

When HP Enterprise Services receives the provider's claim along with a photocopy of an ID card, a hard copy response received through EVS or a transaction log number from the Automated Voice Response (AVR). HP Enterprise Services compares the dates of service with the dates on the card. If the dates of service fall within the dates of eligibility for the ID number on the card, HP Enterprise Services enters a "71" medical

status code and pays the claim immediately. HP Enterprise Services then enters the eligibility dates for the entire month in which services were provided.

If the member was eligible for the entire period of certification shown on the Good Faith form ([F-10111](#)), remove the "71" medical status code and write in the correct code.

Attach an F-10110 (formerly DES 3070) to add the *certification period* and appropriate medical status code for the time when the member was eligible for BadgerCare Plus.

Period of Certification

If HP Enterprise Services has entered the suspected period of certification to be added to the member master file, check it for accuracy. Then complete an F-10110 (formerly DES 3070) and enter the period of certification if the member file does not show eligibility for the time when the member was eligible or for the time covered by an ID card issued to the member.

Control Name Year of Birth

HP Enterprise Services will enter the suspected control name and year of birth (YOB) for the member. This control name must be the first four letters of the member's last name. The YOB is the last two digits in the member's year of birth. Both of these items must match the information currently in the member's HP Enterprise Services file.

Current ID Number

HP Enterprise Services will enter the member's current ID number.

Date of Birth

HP Enterprise Services completes this field only for initial certifications. Change this birth date if the date entered is incorrect. Indicate birth date as MM/DD/CCYY.

Signature of Agency Director

Good Faith forms must have an authorized signature for initial certifications.

Worker ID

On initial certifications, enter the six-digit worker code of the certifying IM worker.

This page last updated in Release Number: 11-03

Release Date: 11/29/11

Effective Date: 11/29/11

[View History](#)

38.7 IMPACT ON DUAL ELIGIBLE INDIVIDUALS

Individuals who are enrolled in Medicare (Part A and/or B) and are eligible for BadgerCare Plus under a Title 19 (Medicaid) funded Med Stat Code (51.1), are referred to as Dual Eligible individuals. Since January 1, 2006, Medicaid does not provide prescription drug coverage for

39.1 Emergency Services Income Limits

these individuals. Instead these individuals receive prescription drug coverage through Medicare Part D.

These Dual Eligible individuals are deemed eligible for "Extra Help" from CMS to help pay for their Medicare Part D drug costs.

A Medicare Part D Preferred Drug Plan (PDP) card will be issued to them and it must be used for prescription drugs instead of their Forward Card.

For more information on Medicare Part D, see:

<http://www.medicare.gov/navigation/medicare-basics/medicare-benefits/part-d.aspx>

*This page last updated in Release Number: 11-01
Release Date: 03/29/11
Effective Date: 03/29/11*

39 Emergency Services

[View History](#)

39.1 EMERGENCY SERVICES INCOME LIMITS

BadgerCare Plus Emergency Services is a limited BadgerCare Plus benefit for documented immigrants who have not been in the U.S. for 5 years or more and for undocumented immigrants.

A citizen is not eligible for BadgerCare Plus Emergency Services even when he or she cannot produce citizenship and/or identity verification.

Example 1: Jill applies for BadgerCare Plus, declares U.S. citizenship and is asked to provide documents proving her citizenship and identity. She has a driver license to prove identity but does not have anything to prove her citizenship. Since Emergency Services BadgerCare Plus does not require proof of citizenship and identity as an eligibility requirement, she then asks to be considered for this program. However, the IM worker cannot process BadgerCare Plus Emergency Services eligibility for persons declaring to be U.S. citizens. BadgerCare Plus Emergency Services is reserved for non-qualifying non-citizens.

Because Emergency Services is funded through Title XIX only those who would receive their BadgerCare Plus benefits under Title XIX are eligible for BadgerCare Plus Emergency Services. Therefore, not everyone who meets the income limits for BadgerCare Plus qualifies for BadgerCare Plus Emergency Services.

Prior to April 2014, an immigrant who only met the eligibility criteria for the BadgerCare Plus Core Plan was not eligible for Emergency Services. Starting April 2014, immigrants who only meet the criteria for BadgerCare Plus under the childless adults' coverage group under *MAGI* rules will also be ineligible for Emergency Services.

An immigrant who is ineligible for BadgerCare Plus because of his or her *immigration status* is eligible for BadgerCare Plus Emergency Services coverage if:

1. He or she meets the income limits listed in the chart below and
2. Meets all other eligibility requirements, except having or applying for an [SSN](#) .

BadgerCare Plus Emergency Services Income Limit Through January 31, 2014

Group	Income
Pregnant Women	Up to 300% FPL
Newborns to age 1	Up to 300% FPL
Children ages 1 - 5	Up to 185% FPL
Children ages 6 - 18	Up to 150% FPL
Former Foster Care Youth	Any FPL Level
Parents and Caretakers	Up to 200% FPL

BadgerCare Plus Emergency Services Income Limit Effective February 1, 2014

A 5% income disregard and 1% conversion factor will be applied to the Emergency Services income limit for pregnant women and children effective January 1, 2014.

Group	Income
Pregnant Women	Up to 306% FPL
Newborns to age 1	Up to 306% FPL
Children ages 1 - 5	Up to 191% FPL
Children ages 6 - 18	Up to 156% FPL
Former Foster Care Youth	Any FPL Level
Parents and Caretakers	Up to 100% FPL

Note: Pregnant *non-qualifying immigrants* may be eligible under the BadgerCare Plus Prenatal Program.

An emergency means a medical condition (including labor and delivery) that shows acute symptoms of sufficient severity (including severe pain) such that the lack of immediate medical treatment could result in one or more of the following:

1. Serious jeopardy to the patient's health.
2. Serious impairment to bodily functions.
3. Serious dysfunction of a bodily organ or part.

BadgerCare Plus Emergency Services covers :

- Only those medical services needed for the treatment of an emergency medical condition.
- All labor and delivery services for eligible non-qualifying immigrants.

See Process Help [Chapter 11.1](#), for BadgerCare Plus Emergency Services manual *application* processing.

his page last updated in Release Number: 14-03

Release Date: 09/02/14

Effective Date: 04/01/14

[View History](#)

39.2 DETERMINING IF AN EMERGENCY EXISTS

It is not the responsibility of the IM agency to determine if the applicant's condition is or was an emergency condition and reimbursable under BadgerCare Plus Emergency Services. The medical provider submits claims for emergency medical services to the *fiscal agent*. The fiscal agent then determines if a condition is an emergency medical condition covered by BadgerCare Plus Emergency Services.

39.2.1 Determining Eligibility

It is the IM agency's responsibility to manually determine if the non-qualifying immigrant meets all eligibility requirements during the dates of service and to certify if he or she is eligible for Emergency Services.

Medicaid providers who have treated non-US citizens for emergency services can provide them with a form verifying that the services provided were to treat an emergency medical condition.

The form is "Certification of Emergency for Non-US Citizens ([F-01162](#)). Providers are instructed to have the patient present this to the local IM agency when applying for assistance.

Note: The [F-01162](#) is not required to certify Emergency Services eligibility.

If a non-qualifying immigrant provides a "Certification of Emergency for Non-U.S. Citizens" at the time of *application*, his or her eligibility for BadgerCare Plus Emergency Services is determined for the dates of the emergency indicated on the form.

If a non-qualifying immigrant does not have the form at the time of application, ask him or her for the dates that he or she received emergency services.

Emergency Services coverage begins at the time of the first treatment for the emergency and ends when the condition is no longer an emergency.

Determine eligibility of a pregnant immigrant on the date emergency services were provided.

The pregnancy due date is required to determine eligibility for pregnant immigrants. (See [39.3](#) for Emergency Services certification dates for pregnant women.)

*If a non-qualifying immigrant would only qualify for BadgerCare Plus if he or she was disabled, follow disability determination procedures (including presumptive disability) before certifying Emergency Services eligibility.

Certification of Emergency Services is not done through *CARES* and must be done manually.

However, all applications should be processed through CARES to determine BadgerCare Plus eligibility. If the immigrant does not have an *SSN*, CARES will assign a pseudo SSN. That pseudo SSN should be used when submitting the manual certification. When an immigrant is determined eligible for Emergency Services, complete and submit a manual certification (F-10110 or DES 3070). See [Process Help 81.3](#). The fiscal agent needs a beginning and end date to process eligibility. In setting the end date, use the last day of the emergency. If that is not known, use the last day of the month in which the emergency is expected to end. Use the AE

39.3 Emergency Services For Pregnant Women

medical status code.

Note: The *Federally Facilitated Marketplace* will send accounts to State consortia and tribal agencies for individuals who have been assessed as potentially eligible for BadgerCare Plus Emergency Services.

The F-10110 may be submitted to the fiscal agent in the following ways:

1. Mail: Forward Health iChange

P.O. Box 7636
Madison, WI 53707-7636

2. Fax: (608) 221-8815

An individual eligible for BadgerCare Plus Emergency Services will not receive a ForwardHealth card because BadgerCare Plus Emergency Services eligibility ends when the emergency ends.

However, women determined eligible for the BadgerCare Plus Prenatal Program will be issued a ForwardHealth Card, which can also be used to access emergency services under the Emergency Services coverage group after the BadgerCare Plus Prenatal Program coverage ends.

39.2.2 Providing Manual Positive or Negative Notice

The IM agency must provide a manual positive or negative notice regarding the applicant's eligibility. Positive notices must provide the dates of eligibility for BadgerCare Plus Emergency Services. Negative notices must provide the reason(s) for the denial or termination.

*this page last updated in Release Number: 13-02
Release Date: 10/25/13
Effective Date: 10/01/13*

[View History](#)

39.3 EMERGENCY SERVICES FOR PREGNANT WOMEN

A pregnant non-qualifying immigrant may apply for emergency services up to one calendar month before her due date. Certify an eligible pregnant non-qualifying immigrant from the date of *application*, if she applies no more than one calendar month prior to her due date, through the end of the month in which the 60th day occurs following her due date. Adjust the *certification period* based on the actual pregnancy end date, once it is known.

Note: As of January 1, 2014, pregnancy is no longer required to be verified.

Example 1: Sara is a pregnant non-qualifying immigrant applying for BadgerCare Plus Emergency Services. Sara has two weeks until her due date, which is March 3rd. Certify Sara for BadgerCare Plus Emergency Services from the date of application through the end of May.

Example 2: Erica applied for BadgerCare Plus Emergency Services because she was a pregnant non-qualifying immigrant on March 13th. Her expected due date is April 5th. Erica is certified for BadgerCare Plus Emergency Services from March 13th through the end of June. Erica delivers her son on March 15th. Her certification period should be adjusted from March 13th through the end of May.

If a pregnant non-qualifying immigrant applies prior to the calendar month, before her due date, and she has not received a service, deny her BadgerCare Plus Emergency Services eligibility because she has not received a service.

If a woman applies for BadgerCare Plus Emergency Services, within three months after her pregnancy has ended, certify her from the pregnancy end date through the end of the month in which the 60th day occurs.

Example 3: Vienne miscarries on April 5th, which is more than one month from her due date of July 15th. Vienne applies on April 6th for BadgerCare Plus Emergency Services. Certify Vienne for BadgerCare Plus Emergency Services from April 5th through the end of June.

Example 4: Guadeloupe was in a car accident and admitted to a Fort Atkinson Hospital on February 18th. On March 15th, Guadeloupe applied for BadgerCare Plus Emergency Services for both the February hospital stay and her pregnancy, with a verified due date of April 15th. Certify Guadeloupe for BadgerCare Plus Emergency Services from February 18th through the end of June.

An immigrant who gives birth while enrolled in BadgerCare Plus Emergency Services remains eligible for emergency services for an additional 60 days after the last day of pregnancy through the end of the month in which the 60th day occurs. The emergency does not have to be related to the pregnancy.

*this page last updated in Release Number: 13-02
Release Date: 10/25/13
Effective Date: 10/01/13*

[View History](#)

39.4 NEWBORNS

Babies born to mothers covered under BadgerCare Plus Emergency Services are BadgerCare Plus eligible as continuously eligible newborns, if all other eligibility conditions are met. ([Chapter 8.2](#))

*This page last updated in Release Number: 07-01
Release Date: 10/29/07
Effective Date: 02/01/08*

[View History](#)

39.5 ELIGIBILITY BEGIN DATE FOR NON-QUALIFYING IMMIGRANTS WHO LOSE ELIGIBILITY FOR THE BADGERCARE PLUS PRENATAL PROGRAM

A non-qualifying immigrant, who loses eligibility for the BadgerCare Plus Prenatal Program ([Chapter 41](#)) when her pregnancy ends, or for any reason other than moving out of state, is eligible for BadgerCare Plus Emergency Services from the date she lost BadgerCare Plus Prenatal Program eligibility. Like other pregnant immigrants, these women should have BC + Emergency Services coverage through the end of the month in which the 60th day occurs, following her due date or the pregnancy end date, if that is known.

Example 1: A pregnant non-qualifying immigrant is found eligible for the BadgerCare Plus Prenatal Program. Her expected due date is July 10th. She is terminated effective April 30th from the BadgerCare Plus Prenatal Program due to non-payment of the BC premium. [CARES](#) will send the [fiscal agent](#) a record terminating her BadgerCare Plus on April 30th, and send a record to certify her as eligible for BadgerCare Plus Emergency Services from May 1st through September 30th.

Pregnant *non-qualifying immigrants* who are not found eligible for the BC Prenatal Program should have BadgerCare Plus Emergency Services eligibility determined according to the instructions in [39.3](#).

Example 2: A pregnant non-qualifying immigrant applies on January 15th. Her expected due date is May 10th. She is denied BadgerCare Plus Prenatal Program

eligibility due to access to health insurance through her employer. To receive Emergency Services, she must re-apply no earlier than April 10th. BadgerCare Plus Emergency Services eligibility continues through the end of the month following the 60th day after the pregnancy ends.

*This page last updated in Release Number: 13-02
Release Date: 10/25/13
Effective Date: 10/01/13*

[View History](#)

39.6 BADGERCARE PLUS DEDUCTIBLE

Immigrants who apply for Emergency Services and who are under 19 years of age and ineligible due to access to health insurance or who are pregnant and have countable household income over 300% of the FPL, may become eligible for BadgerCare Plus Emergency Services through a BadgerCare Plus *deductible*. If, on the date he or she applies and he or she meets all other eligibility criteria, apply the same deductible policies to him or her as any other *applicant*. ([Chapter 17](#))

*This page last updated in Release Number: 07-01
Release Date: 10/29/07
Effective Date: 02/01/08*

40 Family Planning Only Services (FPOS)

[View History](#)

40.1 FAMILY PLANNING ONLY SERVICES PROGRAM

BadgerCare Plus Family Planning Only Services program (*FPOS*) provides limited benefits for family planning services for women and men with income at or below 300% of the FPL (under *non-MAGI* rules) or 306% FPL (under *MAGI* rules) and who are:

1. Of child bearing or reproductive age, and
2. Not enrolled in BadgerCare Plus or receiving other full benefit Medicaid.

For more information about income disregards under MAGI rules, see [16.1.2](#).

Individuals who are eligible for (*FPOS*) may be eligible to receive more than one limited benefit program.

These include:

1. Tuberculosis-related (MEH [25.7](#))
2. Qualified Medicare Beneficiary (MEH [32.2](#))
3. Specified Low-Income Medicare Beneficiary (MEH [32.3](#)).

In certain circumstances, women enrolled in FPOS may be eligible for the Wisconsin Well Woman Medicaid plan. (See [MEH chapter 36](#))”

*This page last updated in Release Number: 14-03
Release Date: 09/05/14
Effective Date: 10/01/14*

[View History](#)

40.2 FPOS PRESUMPTIVE ELIGIBILITY (PE)

[40.2.1 Introduction](#)

[40.2.2 Qualified Entities](#)

[40.2.3 IM Agency](#)

[40.2.4 Express Enrollment Process in ACCESS](#)

40.2.1 Introduction

Note: Wisconsin’s presumptive eligibility programs are known by multiple terms: Express Enrollment, Temporary Enrollment, and Presumptive Eligibility. Express Enrollment (EE) is the **online application** in ACCESS for making PE determinations. Presumptive Eligibility (PE) is the **determination** of whether an applicant is eligible to temporarily enroll in BadgerCare Plus (BadgerCare Plus) or Family Planning Only Services (FPOS). Temporary Enrollment (TE) is when an applicant has been found **eligible to temporarily enroll** in BadgerCare Plus or FPOS. All such policy in this handbook will be collectively referred to as Presumptive Eligibility.

FPOS temporary enrollment through a PE determination provides family planning services beginning on the day that a qualified provider determines that the individual has income at 306% FPL, and is:

1. Of child bearing or reproductive age, and
2. A Wisconsin resident, and

3. Not enrolled in BadgerCare Plus or receiving full benefit Medicaid,
4. One of the following:

For individuals under 19:

- U.S. Citizen, or
- Lawfully present in the United States (no requirement for the amount of time the person is lawfully present in the U.S.).

For individuals age 19 and older:

- U.S. Citizen;
- Lawfully residing in the United States under one of the eligible immigration statuses/situations listed in section [4.3.4](#).

For more information about income disregards under MAGI rules, see [16.1.2](#).

The qualified entity should refer non-citizens to the Income Maintenance Agency (IM) for a BadgerCare Plus eligibility determination.

FPOS PE extends from the date that an individual is determined eligible by the qualified provider through either:

1. The last day of the month following the month in which he or she was determined presumptively eligible, **or**
2. If the individual applies for FPOS by the end of the month following the month in which he or she was found presumptively eligible, the enrollment period ends the day on which the agency determines his or her eligibility.

FPOS PE can only be received once within a rolling 12-month period.

40.2.2 Qualified Entities

Qualified entities are certified ForwardHealth to make PE determinations. A qualified entity determines if an individual is eligible to temporarily enroll in FPOS. If the individual is eligible, the qualified entity will:

1. Complete and sign the Temporary Enrollment for FPOS form ([F-10119](#)). Beginning September 28, 2014, qualified entities will be able to make PE determinations for FPOS using the Express Enrollment process in ACCESS. See [ACCESS Handbook Chapter 12](#).”
2. Complete the temporary ID card ([F-10119](#)) and give it to the member. The certification dates are from the date FPOS PE is determined through the end of the month following the month in which the determination is made.

3. Explain that the duration of a FPOS PE period depends on when the member applies for BadgerCare Plus and ongoing FPOS benefits through the local IM agency.
 - a. If the member applies for ongoing FPOS by the end of the month following the month in which he or she was determined eligible for FPOS PE, the ongoing FPOS period begins the first of the month in which the member applied and is found eligible. The FPOS PE period ends the day before the members ongoing FPOS period begins.

Example 1: Amber applied for FPOS PE on September 19th. She is temporarily enrolled through October 31st.

Amber applied for ongoing FPOS on November 2nd and was found eligible. Amber's ongoing FPOS begins November 1st, and ends October 31st of the following year. Amber did not request a three month backdate.

- b. If the member does not apply by the end of the second month following the month in which he or she was determined eligible for FPOS PE, the FPOS PE period ends the last day of the second month following the month in which the member was determined eligible for FPOS PE.

Example 2: Brenda applied for FPOS PE on April 3, 2011. Her FPOS PE continues through May 31, 2011. Brenda does not apply for ongoing FPOS until August 15, 2011 and is found eligible. Brenda requests a backdate of the FPOS for three months and is found eligible. Her FPOS is backdated to May 1, 2011.

4. Send a copy of the completed [F-10119](#) to the [fiscal agent](#) within five days of completion.

40.2.3 IM Agency

If an individual applies for ongoing FPOS at the IM agency on or before the last day of the FPOS PE period:

1. Verify the member is presumptively by checking ForwardHealth interChange for a medical status code of PF.

2. Consider the [application](#) filed if the member's name, address and signature are on the application.
3. If you are unable to finish processing the application, by the end of the FPOS PE period, submit an [F-10110](#) to extend the FPOS PE period for an additional calendar month.

40.2.4 Express Enrollment Process in ACCESS

Refer to [ACCESS Handbook](#) Chapter 12 for more information on determining presumptive eligibility for BadgerCare Plus using the Express Enrollment process in ACCESS.

*This page last updated in Release Number: 14-03
Release Date: 09/05/14
Effective Date: 10/01/14*

[View History](#)

40.3 FPOS APPLICATION

Eligibility for *FPOS* begins on the first of the month of *application* , if all non-financial ([40.4](#)) and financial ([40.5](#)) eligibility requirements are met. FPOS may be backdated up to three months from the month of application

*This page last updated in Release Number: 10-05
Release Date: 12/15/10
Effective Date: 12/15/10*

[View History](#)

40.4 FPOS NON-FINANCIAL REQUIREMENTS

The following are *FPOS* specific non-financial requirements:

1. Of child bearing or reproductive age,
2. A Wisconsin resident, and
3. Not be enrolled in BadgerCare Plus or receiving other full benefit Medicaid.
4. One of the following:

For individuals under age 19:

- Lawfully residing in the United States (no requirement for the amount of time the person is lawfully present in the U.S.).

For non-pregnant individuals age 19 and older:

- U.S. Citizen; or
- Lawfully residing in the United States under one of the eligible immigration statuses/situations listed in section [4.3.4](#).

5. Meet all BadgerCare Plus non-financial criteria (See [Section 2.1](#)) with the exceptions listed below:
 - An individual applying for or receiving BadgerCare Plus FPOS is not subject to the health insurance access or coverage policies.
 - An individual applying for or receiving BadgerCare Plus FPOS is not required to cooperate with Medical Support, unless he or she is also applying for or receiving BadgerCare Plus for any child for whom he or she is the *caretaker relative*.
 - An individual applying for or receiving BadgerCare Plus FPOS is not required to cooperate with *Third Party Liability (TPL)*, unless he or she is also applying for or receiving BadgerCare Plus for any child for whom he or she is the caretaker relative.
 - Any individual applying for or receiving FPOS who refuses to cooperate with MSL or TPL requirements when he or she has a child in the home who is receiving BadgerCare Plus or Medicaid, is ineligible for FPOS unless he or she is under 19 or has *Good Cause*.

This page last updated in Release Number: 14-03

Release Date: 09/02/14

Effective Date: 10/01/14

[View History](#)

40.5 FPOS FINANCIAL REQUIREMENTS

[40.5.1 Financial Eligibility Requirements Specific to FPOS](#)

[40.5.2 Income Under MAGI Rules](#)

40.5.1 Financial Eligibility Requirements Specific to FPOS

The following specific financial eligibility requirements apply to **FPOS** members, regardless of the methodology used to determine his or her **FPOS** income:

1. Countable income calculated in the **application** month is used to determine the member's financial eligibility for the entire 12-month eligibility period. Income changes do not need to be reported until the next review.
2. Any change in income or household size reported after confirmation for **FPOS** during the 12-month eligibility period is only applied if it results in enrollment in BadgerCare Plus with no premium or eligibility for other full benefit Medicaid.
3. All changes in income or household composition that result in enrollment in BadgerCare Plus with no premium or eligibility for other full benefit Medicaid will result in **FPOS** closure prior to the 12th month.
4. All changes in income will be applied at the 12-month **FPOS** eligibility renewal.

40.5.2 Income Under MAGI Rules

Because FPOS eligibility is determined based on a group size of one, the applicant's taxable earned and unearned income is the only income that should be used when calculating their income for purposes of FPOS eligibility under MAGI rules. When a child under 19 is applying, their parents' income is not included in his or her eligibility determination. If a married individual is applying for FPOS coverage, do not include the income of the spouse, even if he or she is living with his or her spouse.

*This page last updated in Release Number: 13-02
Release Date: 10/25/13
Effective Date: 10/01/13*

[View History](#)

40.6 FPOS GROUP

[40.6.1 Fetus](#)

[40.6.2 Children 18 Years of Age](#)

[40.6.3 FPOS Group under MAGI Rules](#)

[40.6.4 Transitioning to MAGI Rules](#)

40.6.1 Fetus

For *non-MAGI* based FPOS groups, increase the *FPOS* group by one for each fetus a pregnant woman in the *FPOS* group is carrying.

Example: Samantha and Howard are married, and have two minor daughters, Shannon and Colleen. Shannon is pregnant. Samantha is only requesting *FPOS* for herself, and is requesting BadgerCare Plus for her two daughters.

Shannon and Colleen are found eligible for BadgerCare Plus. In building the *FPOS* group, Shannon, Shannon's fetus, and Colleen are counted children. Howard is part of the *FPOS* group, because he is legally responsible for Samantha. The *FPOS* group size is five for Samantha.

40.6.2 Children 18 years of Age

For *non-MAGI* based FPOS groups, children under 19 who are applying for *FPOS* are a group of one, unless he or she is married and/or has children. Parents are not included in the group.

40.6.3 FPOS Group under MAGI Rules

For all individuals, including children under 19, whose eligibility for *FPOS* is determined under *MAGI* rules, the group size of the applicant will always be one, regardless of his or her marital status, pregnancy status, and whether or not he or she has children or tax dependents.

40.6.4 Transitioning to MAGI Rules

Current *FPOS* members whose eligibility for the program is based on *non-MAGI* rules will transition to *MAGI* rules in the same manner as BadgerCare Plus members: on March 31, 2014 or their regularly scheduled 2014 renewal, whichever is later.

All applicants to the *FPOS* program who apply on or after February 1, 2014 will have his or her eligibility determined under *MAGI* rules.

*This page last updated in Release Number: 14-01
Release Date: 02/07/14
Effective Date: 02/01/14*

[View History](#)

40.7 FPOS PROGRAM CHOICE

An individual applying for both BadgerCare Plus and *FPOS* may request at any time to discontinue enrollment in BadgerCare Plus in order to receive only FPOS. Change the health care request on the program request page to "No" in order to receive the FPOS.

An individual applying for both BadgerCare Plus and FPOS is not given a choice at the time of confirmation if he or she meets the eligibility for both benefits. He or she will be enrolled in BadgerCare Plus.

An individual found to be eligible for a *deductible* may also be eligible for FPOS benefits during a deductible period. The member may receive FPOS benefits until he or she has met a deductible. The member can report any out-of-pocket medical bills incurred while he or she is receiving services through FPOS, in order to meet a deductible. Once a deductible has been met, he or she is receiving full-benefit BadgerCare Plus/ Medicaid, and is no longer eligible for FPOS. However, he or she will continue to receive the same family planning services through BadgerCare Plus/Medicaid.

Example: Theresa is an 18-year-old woman applying for Medicaid, BadgerCare Plus and FPOS for herself and for BadgerCare Plus for her daughter Sara (age three). She is found to be eligible for BadgerCare Plus with a premium or a deductible. If Theresa chooses BadgerCare Plus, she is required to pay a premium but would be able to receive family planning services through BadgerCare Plus as well as having coverage for her whole family. If she chooses the deductible, she can receive family planning-related services through FPOS until her deductible has been met.

*This page last updated in Release Number: 13-02
Release Date: 10/25/13
Effective Date: 10/01/13*

[View History](#)

40.8 FPOS CHANGES

Members receiving *FPOS* only are not required to report changes in income or household composition during the 12-month *certification period*. However, FPOS members are still required to report all other changes that would result in ineligibility such as moving out of state, incarceration, etc. within 10 days of the change.

Changes reported in household composition or income resulting in ineligibility will not affect FPOS benefits for the remainder of the 12-month certification period. Eligibility is put into an extension phase until the end of the 12-month certification period or until the member reports an income decrease that is again below the FPOS income limit.

Note: Household composition changes will not affect eligibility when the member's eligibility is

40.9 FPOS BadgerCare Plus Extension Phase

determined using *MAGI* rules in 2014, as all FPOS assistance groups will only include the member in the household composition, regardless of his or her living arrangement.

Changes reported in income or household composition resulting in eligibility for BadgerCare Plus should be applied. If there is a request for BadgerCare Plus on file, he or she will be found eligible for BadgerCare Plus. At that time, FPOS will end.

FPOS eligibility terminates when a member loses non-financial eligibility. Terminate eligibility, using *adverse action* logic, when she:

1. Moves out of state.
2. Is 19 years or over and is no longer cooperating with TPL, Medical Support, or Social Security Number (*SSN*) requirements.
3. Enrolls in BadgerCare Plus or becomes eligible for other full benefit Medicaid.
4. Becomes an inmate of a public institution.

*This page last updated in Release Number: 14-04
Release Date: 11/20/14
Effective Date: 11/20/14*

[View History](#)

40.9 FPOS BADGERCARE PLUS EXTENSION PHASE

An *FPOS* member enters into a FPOS extension phase if a change is reported at any time during the 12-month *certification period* in income or household composition that results in income that exceeds the FPOS income limit.

The extension continues until the renewal date that was originally set for the FPOS eligibility.

Note: Household composition changes will not affect eligibility when the member's eligibility is determined using *MAGI* rules in 2014, as all FPOS assistance groups will only include the member in the household composition, regardless of his or her living arrangement.

This page last updated in Release Number: 13-02

Release Date: 10/25/13

Effective Date: 10/01/13

[View History](#)

40.10 FPOS REVIEWS AND RECERTIFICATIONS

A renewal/recertification ([Chapter 26](#)) is required every 12 months, after an initial eligibility determination. At the time of the *FPOS* renewal, income and household composition are again tested against the FPOS eligibility criteria.

If a member completes a renewal for another program of assistance at any time during the 12 month FPOS *certification period* and the information collected from that renewal indicates that she still meets FPOS eligibility requirements, the FPOS renewal date will be set 12 months from that renewal date.

If a member completes a renewal for another program of assistance at any time before the 12th month of FPOS eligibility ends, and no longer meets the FPOS eligibility requirements, he or she will enter into an FPOS extension phase. He or she will be required to complete a renewal at the end of the original 12-month certification period. If at this renewal, he or she is found to still have income in excess of the FPOS limit, eligibility for FPOS ends.

Through December 31, 2013, FPOS cases can be selected for administrative renewal ([26.1.2](#)). These cases must meet all the following criteria to be selected for this process:

- No child in household turning 18 in current or next month
- Countable income of individuals age 18 and above at or below 275% of the FPL.

Administrative renewals for FPOS case will not be allowed in 2014.

This page last updated in Release Number: 13-02

Release Date: 10/25/13

Effective Date: 10/01/13

[View History](#)

40.11 FPOS CONFIDENTIALITY

41.1 BadgerCare Plus Prenatal Program

Members applying for or receiving *FPOS* benefits will have all of the confidentiality protections as other BadgerCare Plus applicants, as well as the following additional confidentiality protections:

1. If requested, member can have written communication sent to an alternate address instead of the home address.
2. Minors are not referred to child support.
3. Eligibility information regarding minors who apply independently for FPOS is kept confidential from parents or guardians, unless the member gives clear consent for release of the information.

*This page last updated in Release Number: 10-05
Release Date: 12/15/10
Effective Date: 12/15/10*

41 BadgerCare Plus Prenatal Program

[View History](#)

41.1 BADGERCARE PLUS PRENATAL PROGRAM

The BadgerCare Plus Prenatal Program provides coverage for women who:

- Meet the non-financial and financial eligibility requirements for BadgerCare Plus outside of incarceration or immigration status
- Have verified pregnancies, and
- Are not eligible for BadgerCare Plus because they are either inmates of a public institution or *Non-qualifying immigrants*.

Note: Pregnancy will no longer be verified for the BadgerCare Plus Prenatal Program beginning on January 1, 2014. Only verify pregnancy if the worker has information that contradicts the member or *applicant's* self-declared information.

*This page last updated in Release Number: 13-02
Release Date: 10/25/13
Effective Date: 10/01/13*

[View History](#)

41.2 BADGERCARE PLUS PRENATAL PROGRAM ELIGIBILITY REQUIREMENTS

Pregnant women (or when applicable, their assistance group), must meet the following BadgerCare Plus eligibility requirements to qualify for the BadgerCare Plus Prenatal Program:

1. The applicant's net countable income must not exceed 300% of the FPL (under *non-MAGI* rules) or 306% of the FPL (under *MAGI* rules).
2. The [applicant](#) must not have current or past access to an employer's health insurance benefit where the employer pays 80% or more of the premium cost or to any State of Wisconsin health insurance plan.
3. The applicant must provide any required verifications.

Note: For eligibility beginning on or after January 1, 2014, pregnancy will only be verified if the worker has information that contradicts the applicant's self-declared information.

4. The applicant must not have health insurance coverage ([Chapter 7](#)) through any HIPAA standard plan now or in the three calendar months prior to the BadgerCare Plus Prenatal request.

41.2.1 Unique Aspects of BadgerCare Plus Prenatal Program

1. Providing an *SSN* is not an eligibility requirement for either inmates or *non-qualifying immigrants* applying for the BadgerCare Plus Prenatal Program.
2. Cooperation with Child Support Enforcement is not an eligibility requirement for this program.
3. Unlike regular BadgerCare Plus which locks in eligibility throughout the pregnancy, BadgerCare Plus Prenatal Program eligibility may be terminated with timely notice for failure to meet any of the BadgerCare Plus eligibility requirements listed in [41.1](#).
4. There is no Presumptive Eligibility for the BadgerCare Plus Prenatal Program. Eligibility for the BadgerCare Plus Prenatal Program may only be determined by the IM agencies.
5. There is no 3-month backdating option available for Prenatal Program members.
6. Unlike BadgerCare Plus for Pregnant Women, Prenatal Program members are not eligible for the 60-day pregnancy extension, but are eligible for Emergency Services during that time.

*This page last updated in Release Number: 13-02
Release Date: 10/25/13*

Effective Date: 10/01/13

[View History](#)

41.3 BADGERCARE PLUS PRENATAL POLICY FOR NON-QUALIFYING IMMIGRANTS

1. For immigrants who are legally present in the United States, verify [immigration status](#) through normal [SAVE](#) procedures in order to determine eligibility for BadgerCare Plus. If SAVE verifies the pregnant woman is a non-qualifying immigrant, proceed with determining eligibility for the BadgerCare Plus Prenatal Program.
2. For immigrants who do not have legal immigration status, do not request SAVE verification and continue with the determination of eligibility for the BadgerCare Plus Prenatal Program.
3. A non-qualifying immigrant whose immigration status changes while she is pregnant and receiving BadgerCare Plus Prenatal benefits must have her eligibility re-determined using the new immigration status. If her new status makes her eligible for BadgerCare Plus for Pregnant Women, she is no longer eligible for the BadgerCare Plus Prenatal Program.

This page last updated in Release Number: 13-02

Release Date: 10/24/13

Effective Date: 10/01/13

[View History](#)

41.4 BADGERCARE PLUS PRENATAL PROGRAM POLICY FOR INMATES

1. Inmates will always be considered to be residing in the county where the jail or prison facility is located.
2. An inmate who is released from jail or prison while receiving BadgerCare Plus Prenatal Program must have her eligibility re-determined based on her new circumstances. Once released from an institution, she is no longer eligible for the BadgerCare Plus Prenatal Program.

Note: When a BadgerCare Plus Prenatal Program member notifies the IM agency that she has become a citizen or qualifying immigrant, or is released from prison or jail, **CARES** will redetermine BadgerCare Plus eligibility based on the new information.

*This page last updated in Release Number: 08-03
Release Date: 03/11/08
Effective Date: 03/11/08*

[View History](#)

41.5 BADGERCARE PLUS PRENATAL PROGRAM ELIGIBILITY BEGIN DATE

BadgerCare Plus Prenatal Program eligibility begins no sooner than the first of the month in which a valid *application* is received. For applicants whose eligibility is beginning prior to December 31, 2013, the pregnancy must be verified before eligibility can begin.

Example: An application for the BadgerCare Plus Prenatal Program is received on October 20, 2013. The agency does not receive a verification of the pregnancy until November 5th. BadgerCare Plus Prenatal Program is denied for October due to lack of pregnancy verification in that month. If the woman is otherwise eligible for the BadgerCare Plus Prenatal Program, eligibility may begin on November 1st.

Pregnant *non-qualifying immigrants* who are not eligible for the BadgerCare Plus Prenatal Program should have Emergency Services eligibility determined according to policy in ([Chapter 39](#)).

*This page last updated in Release Number: 13-02
Release Date: 10/25/13
Effective Date: 10/01/13*

[View History](#)

41.6 BADGERCARE PLUS PRENATAL ELIGIBILITY END DATE

BadgerCare Plus Prenatal Program eligibility ends when the pregnancy ends. Benefits will continue through the end of the month following timely notice requirements.

Non-qualifying immigrants who lose eligibility for the BadgerCare Plus Prenatal Program when their pregnancy ends, for any reason other than moving out of state, are eligible for Emergency Services ([Chapter 39](#)) from the time they lose BadgerCare Plus Prenatal Program eligibility.

*This page last updated in Release Number: 07-01
Release Date: 10/29/07
Effective Date: 02/01/08*

[View History](#)

41.7 DETERMINING BADGERCARE PLUS PRENATAL GROUP

[41.7.1 The BadgerCare Plus Prenatal Group through January 31, 2014](#)

[41.7.2 The BadgerCare Plus Prenatal Group after February 1, 2014](#)

41.7.1 The BadgerCare Plus Prenatal Group through January 31, 2014

For individuals who applied prior to January 31, 2014, continue to form the BadgerCare Plus Prenatal group according to the following rules:

1. If a pregnant woman is in a household where her spouse or her children are eligible, or applying for BadgerCare Plus, she is to be included in the BadgerCare Plus group with the other non-financially eligible members of her family. Include the number of verified fetuses when determining the BadgerCare Plus group size. If the number is not verified, always count one fetus.
2. Pregnant inmates must always be considered to be living alone. If the inmate is married while incarcerated, consider her to be separated (ignore the spouse) when determining eligibility. The pregnant inmate's BadgerCare Plus group size will always include herself and the number of fetuses she is carrying.

Note: Women in the Huber program who are eligible for BadgerCare Plus are not eligible for the BadgerCare Plus Prenatal Program.

3. Pregnant *Non-qualifying immigrants* who have no other born children in the home will have their financial eligibility determined in the same way as pregnant women applying for BadgerCare Plus. The BadgerCare Plus group size will only include the woman, the fetuses and her spouse. If the pregnant immigrant is a minor living with her parent(s), the parent(s) will be included in the BadgerCare Plus Test Group.

BadgerCare Plus Prenatal Program Group Examples

Household	Test Group Size	Participation Status	
Mom and fetus	2	EA	
Mom and fetus, boyfriend/alleged father	2	EA	XA
Mom and fetus,	3	EA	CA

spouse				
Mom and fetus, father, and child-in-common eligible for BC	4	EA	EA	EC
Minor Mom and fetus and Minor's parents (2)	4	EC	EA	EA

41.7.2 The BadgerCare Plus Prenatal Group After February 1, 2014

Effective February 1, 2014, all new applicants for the BadgerCare Plus Prenatal Program will have their eligibility determined under MAGI rules. Follow the rules outlined in Chapter 2 in order to form group size.

Beginning January 1, 2014, pregnancy, the number of fetuses, and the due date are not required to be verified unless the worker has information that contradicts the applicant's self-declared information. The effective begin date for the BadgerCare Plus Prenatal Program is the first of the month in which they apply and are otherwise eligible.

*This page last updated in Release Number: 14-01
Release Date: 02/07/14
Effective Date: 02/01/14*

[View History](#)

41.8 BADGERCARE PLUS PRENATAL PROGRAM BENEFIT INFORMATION

Women determined eligible for the BadgerCare Plus Prenatal Program receive a ForwardHealth card, which can also be used to access emergency services under BadgerCare Plus Emergency Services only after BadgerCare Plus ends.

BadgerCare Plus Prenatal Program and BadgerCare Plus Emergency Services members will not be enrolled in an HMO. Services will only be provided on a fee-for-service basis.

*This page last updated in Release Number: 07-01
Release Date: 10/29/07
Effective Date: 02/01/08*

42 Long-term Care for Childless Adults

[View History](#)

42.0 LONG-TERM CARE FOR CHILDLESS ADULTS

Institutionalized childless adults who do not meet the eligibility criteria for *EBD* Medicaid but are eligible for BadgerCare Plus under the *MAGI* rules are eligible to have their *LTC* services covered by BadgerCare Plus if they are functionally eligible. "Institutionalized" means the individual has resided in a medical institution for 30 or more consecutive days or is likely to reside in a medical institution for 30 or more consecutive days.

42.1 Long-term Care Eligibility Requirements for Childless Adults Eligible for BadgerCare Plus

In order to be eligible to have their LTC services covered by BadgerCare Plus while they are institutionalized, childless adults need to meet the following requirements:

- They do not meet the eligibility criteria for EBD Medicaid. This includes any of the following:
 - They do not meet the asset test for EBD Medicaid.
 - They do not meet the income test for EBD Medicaid.
 - They fail to provide or verify asset information or any other information needed to determine EBD Medicaid eligibility.
 - They have not yet been determined disabled.
 - They have not yet been determined presumptively disabled.
- They are eligible for BadgerCare Plus as a childless adult.
- They have not divested in order to qualify for receipt of LTC services. Institutionalized childless adults who divest are not eligible for LTC services although they remain eligible for Medicaid services.
- They disclose information about any annuities purchased on or after January 1, 2009, in which they or their community spouse have an interest.
- They designate the state of Wisconsin as the remainder beneficiary of any annuities purchased or created on or after January 1, 2009.
- If they own their own home, the equity interest in the home must not exceed \$750,000 (see the [Medicaid Eligibility Handbook Section 16.8.1.4 Home Equity over \\$750,000.00](#)) in order to receive LTC services.
- They assign to the state of Wisconsin their rights to payments from a nursing home, hospital, or LTC insurance policy and send any payments to the state of Wisconsin that they received from a nursing home, hospital, or LTC insurance carrier while receiving BadgerCare Plus.

*This page last updated in Release Number: 15-02
Release Date: 09/02/2015
Effective Date: 05/11/2015*

[View History](#)

42.2 PATIENT LIABILITY, ESTATE RECOVERY, AND OTHER POLICIES FOR CHILDLESS ADULTS ELIGIBLE FOR BADGERCARE PLUS WHILE IN LONG-TERM CARE

The following conditions apply to any childless adult who is eligible for BadgerCare Plus under the *MAGI* rules while institutionalized:

- The individual does not have any nursing home patient liability.
- The individual is still subject to regular copayments for medical services unless his or her net countable income is equal to \$0.
- The individual is exempt from HMO enrollment unless he or she is enrolled in a Family Care *MCO*, in which case, the individual can continue to be enrolled in the Family Care MCO.
- The individual is not subject to an asset limit.
- The individual is not subject to having a lien put on his or her home (see the [Medicaid Eligibility Handbook Section 22.1.4 Liens](#)).
- The LTC services the individual receives are not subject to estate recovery (see the [Medicaid Eligibility Handbook Section 22.1.2 Recoverable Services](#)) unless the individual is 55 years old or older.

This page last updated in Release Number: 15-02

Release Date: 09/02/2015

Effective Date: 05/11/2015

[View History](#)

42.3 INSTITUTIONALIZED INDIVIDUALS DETERMINED ELIGIBLE FOR ELDERLY, BLIND, OR DISABLED MEDICAID

The conditions outlined in [Section 42.2 Patient Liability, Estate Recovery, and Other Policies for Childless Adults Eligible for BadgerCare Plus While in Long-term Care](#) only apply to institutionalized individuals while they remain eligible for BadgerCare Plus as a childless adult. When an institutionalized individual has been determined eligible for *EBD* Medicaid, he or she is not eligible for BadgerCare Plus as a childless adult. When an individual becomes eligible for *LTC* under EBD Medicaid rules, he or she is subject to regular estate recovery rules and will have to pay the monthly nursing home patient liability. If the individual later becomes ineligible for EBD Medicaid, he or she may again become eligible for BadgerCare Plus under *MAGI* rules.

Example 1: Andrew is institutionalized and is eligible for BadgerCare Plus as a childless adult under the *MAGI* rules. BadgerCare Plus covers his *LTC* services.

Andrew starts receiving Medicare on August 1, so he is no longer eligible for BadgerCare Plus as a childless adult as of August 1. To continue receiving coverage for LTC services, Andrew would have to meet all regular EBD Medicaid eligibility criteria. He would then be subject to regular estate recovery rules and patient liability.

Example 2: Jana is an institutionalized childless adult eligible for BadgerCare Plus and is waiting on a disability determination. She will receive coverage for LTC services under BadgerCare Plus until the agency receives and processes the disability determination. Once this happens, if she meets all other criteria for EBD Medicaid (including providing asset information and meeting the asset test), she will begin receiving coverage of LTC services under EBD Medicaid. However, if Jana still does not meet all of the eligibility criteria for EBD Medicaid (for example, because she fails to verify assets), she will continue to receive coverage for LTC services under BadgerCare Plus as long as she continues to meet all of the eligibility criteria for BadgerCare Plus.

*This page last updated in Release Number: 15-02
Release Date: 09/02/2015
Effective Date: 05/11/2015*

43 BadgerCare Plus Core Plan

[View History](#)

43.1 BADGERCARE PLUS CORE PLAN

The BadgerCare Plus Core Plan ended on March 31, 2014. This entire chapter has been removed. To see policy history about the BadgerCare Plus Core Plan, refer to Chapter 43 in the archived PDF versions of the BadgerCare Plus Handbook prior to Release 14-02.

*This page last updated in Release Number: 14-02
Release Date: 05/13/14
Effective Date: 04/01/14*

44 Reserved

[View History](#)

RESERVED

*This page last updated in Release Number: 13-02
Release Date: 10/25/13
Effective Date: 10/01/13*

45 BC+ Basic Plan

[View History](#)

45.1 BADGERCARE PLUS BASIC PLAN

The BadgerCare Plus Basic Plan ended on March 31, 2014. This entire chapter has been removed. To see policy history about the BadgerCare Plus Basic Plan, refer to Chapter 45 in the previous PDF versions of the BadgerCare Plus Handbook prior to Release 14-02.

*This page last updated in Release Number: 14-02
Release Date: 05/14/14
Effective Date: 02/01/14*

46-47 Reserved

RESERVED

TABLES (CHAPTERS 48-52)

48 Premiums

[View History](#)

48.1 BADGERCARE PLUS PREMIUM TABLES

[48.1.1 Premiums for Children](#)

[48.1.2 Premiums for Adults](#)

[48.1.3 Premiums for Adult Caretaker Families with Self-Employment Income](#)

48.1.1 Premiums for Children

Under *MAGI* rules, non-exempt children whose BadgerCare Plus eligibility is determined under MAGI rules and with an assistance group income above 201 percent of the *FPL* will be required to pay premiums. Each child's premium will be based on his or her own assistance group's size and income. The five percent cap for the cost of total household premiums for children will continue to apply. The cap will be five percent of the income of the premium paying assistance group with the highest countable income amount. The total household's premiums will be determined based on the combined amount of all children's premiums or the five percent cap, whichever amount is less. See [Section 19.2 Premium Calculations](#) and [Section 19.3 Premium Limits](#) for more information on premium caps.

The below table outlines the premium amounts for children whose income is determined under MAGI rules.

FPL Income Range	Above 201% to 210.99%	211% to 220.99%	221% to 230.99%	231% to 240.99%	241% to 250.99%	251% to 260.99%	261% to 270.99%	271% to 280.99%	281% to 290.99%	291% to 300.99%	301% to 306.00%
Premium Amounts	\$10	\$10	\$10	\$15	\$23	\$34	\$44	\$55	\$68	\$82	\$97.53

Note: Children in extensions are not required to pay premiums (see [Section 19.1 BadgerCare Plus Premiums](#)). If a parent in the household is in an extension, the children are exempt from paying premiums regardless of their income.

48.1.2 Premiums for Adults

The tables below provide the range of premiums for adults in BadgerCare Plus based on family size and income level. The amounts listed for households with incomes over 200 percent of the FPL apply to families in a BadgerCare Plus Extension and to members whose income increases after their renewal approval.

48.1 BadgerCare Plus Premium Tables

BadgerCare Plus parents, caretakers, and childless adults with income at or below 100 percent of the FPL are not required to pay premiums. Non-exempt parents and caretakers in an extension with income above 133 percent of the FPL are required to pay premiums. Effective with extensions that begin on or after April 1, 2014, non-exempt parents and caretakers in an extension with income between 100 and 133 percent of the FPL are required to pay premiums starting in the seventh calendar month of their extension.

Click the link below to see the premiums for different assistance groups.

[Family Size 1](#) [Family Size 6](#)
[Family Size 2](#) [Family Size 7](#)
[Family Size 3](#) [Family Size 8](#)
[Family Size 4](#) [Family Size 9](#)
[Family Size 5](#) [Family Size 10](#)

Family Size	FPL%	Monthly Income	Premium Rate	Monthly Premium Range
1	100.01–133%	\$990.01–1,316.70	2.0%	\$20–26
	133.01–139.99%	\$1,316.71–1,385.99	3.0%	\$40–42
	140–149.99%	\$1,386.00–1,484.99	3.5%	\$49–52
	150–159.99%	\$1,485.00–1,583.99	4.0%	\$59–63
	160–169.99%	\$1,584.00–1,682.99	4.5%	\$71–76
	170–179.99%	\$1,683.00–1,781.99	4.9%	\$82–87
	180–189.99%	\$1,782.00–1,880.99	5.4%	\$96–102
	190–199.99%	\$1,881.00–1,979.99	5.8%	\$109–115
	200–209.99%	\$1,980.00–2,078.99	6.3%	\$125–131
	210–219.99%	\$2,079.00–2,177.99	6.7%	\$139–146
	220–229.99%	\$2,178.00–2,276.99	7.0%	\$152–159
	230–239.99%	\$2,277.00–2,375.99	7.4%	\$168–176

240– 249.99%	\$2,376.00– 2,474.99	7.7%	\$183– 191
250– 259.99%	\$2,475.00– 2,573.99	8.1%	\$200– 208
260– 269.99%	\$2,574.00– 2,672.99	8.3%	\$214– 222
270– 279.99%	\$2,673.00– 2,771.99	8.6%	\$230– 238
280– 289.99%	\$2,772.00– 2,870.99	8.9%	\$247– 256
290– 299.99%	\$2,871.00– 2,969.99	9.2%	\$264– 273
300%+	\$2,970.00+	9.5%	\$282+

For incomes over 300 percent of the FPL, multiply the net income times .095 and round to the nearest dollar to get the premium amount.

Family Size	FPL%	Monthly Income	Premium Rate	Monthly Premium Range
2	100.01– 133%	\$1,335.01– 1,775.55	2.0%	\$27–36
	133.01– 139.99%	\$1,775.56– 1,868.99	3.0%	\$53–56
	140– 149.99%	\$1,869.00– 2,002.49	3.5%	\$65–70
	150– 159.99%	\$2,002.50– 2,135.99	4.0%	\$80–85
	160– 169.99%	\$2,136.00– 2,269.49	4.5%	\$96–102
	170– 179.99%	\$2,269.50– 2,402.99	4.9%	\$111–118
	180– 189.99%	\$2,403.00– 2,536.49	5.4%	\$130–137
	190– 199.99%	\$2,536.50– 2,669.99	5.8%	\$147–155
	200– 209.99%	\$2,670.00– 2,803.49	6.3%	\$168–177
	210– 219.99%	\$2,803.50– 2,936.99	6.7%	\$188–197
	220– 229.99%	\$2,937.00– 3,070.49	7.0%	\$206–215
230–	\$3,070.50–	7.4%	\$227–237	

48.1 BadgerCare Plus Premium Tables

	239.99%	3,203.99		
	240– 249.99%	\$3,204.00– 3,337.49	7.7%	\$247–257
	250– 259.99%	\$3,337.50– 3,470.99	8.1%	\$270–281
	260– 269.99%	\$3,471.00– 3,604.49	8.3%	\$288–299
	270– 279.99%	\$3,604.50– 3,737.99	8.6%	\$310–321
	280– 289.99%	\$3,738.00– 3,871.49	8.9%	\$333–345
	290– 299.99%	\$3,871.50– 4,004.99	9.2%	\$356–368
	300%+	\$4,005.00+	9.5%	\$380+

For incomes over 300 percent of the FPL, multiply the net income times .095 and round to the nearest dollar to get the premium amount.

Family Size	FPL%	Monthly Income	Premium Rate	Monthly Premium Range
3	100.01– 133%	\$1,680.01– 2,234.40	2.0%	\$34–45
	133.01– 139.99%	\$2,234.41– 2,351.99	3.0%	\$67–71
	140– 149.99%	\$2,352.00– 2,519.99	3.5%	\$82–88
	150– 159.99%	\$2,520.00– 2,687.99	4.0%	\$101–108
	160– 169.99%	\$2,688.00– 2,855.99	4.5%	\$121–129
	170– 179.99%	\$2,856.00– 3,023.99	4.9%	\$140–148
	180– 189.99%	\$3,024.00– 3,191.99	5.4%	\$163–172
	190– 199.99%	\$3,192.00– 3,359.99	5.8%	\$185–195
	200– 209.99%	\$3,360.00– 3,527.99	6.3%	\$212–222
	210– 219.99%	\$3,528.00– 3,695.99	6.7%	\$236–248
	220– 229.99%	\$3,696.00– 3,863.99	7.0%	\$259–270
230–	\$3,864.00–	7.4%	\$286–298	

	239.99%	4,031.99		
	240– 249.99%	\$4,032.00– 4,199.99	7.7%	\$310–323
	250– 259.99%	\$4,200.00– 4,367.99	8.1%	\$340–354
	260– 269.99%	\$4,368.00– 4,535.99	8.3%	\$363–376
	270– 279.99%	\$4,536.00– 4,703.99	8.6%	\$390–405
	280– 289.99%	\$4,704.00– 4,871.99	8.9%	\$419–434
	290– 299.99%	\$4,872.00– 5,039.99	9.2%	\$448–464
	300%+	\$5,040.00+	9.5%	\$479+

For incomes over 300 percent of the FPL, multiply the net income times .095 and round to the nearest dollar to get the premium amount.

Family Size	FPL%	Monthly Income	Premium Rate	Monthly Premium Range
4	100.01– 133%	\$2,025.01– 2,693.25	2.0%	\$41–54
	133.01– 139.99%	\$2,693.26– 2,834.99	3.0%	\$81–85
	140– 149.99%	\$2,835.00– 3,037.49	3.5%	\$99–106
	150– 159.99%	\$3,037.50– 3,239.99	4.0%	\$122–130
	160– 169.99%	\$3,240.00– 3,442.49	4.5%	\$146–155
	170– 179.99%	\$3,442.50– 3,644.99	4.9%	\$169–179
	180– 189.99%	\$3,645.00– 3,847.49	5.4%	\$197–208
	190– 199.99%	\$3,847.50– 4,049.99	5.8%	\$223–235
	200– 209.99%	\$4,050.00– 4,252.49	6.3%	\$255–268
	210– 219.99%	\$4,252.50– 4,454.99	6.7%	\$285–298
	220– 229.99%	\$4,455.00– 4,657.49	7.0%	\$312–326
	230–	\$4,657.50–	7.4%	\$345–360

48.1 BadgerCare Plus Premium Tables

	239.99%	4,859.99		
	240– 249.99%	\$4,860.00– 5,062.49	7.7%	\$374–390
	250– 259.99%	\$5,062.50– 5,264.99	8.1%	\$410–426
	260– 269.99%	\$5,265.00– 5,467.49	8.3%	\$437–454
	270– 279.99%	\$5,467.50– 5,669.99	8.6%	\$470–488
	280% - 289.99%	\$5,670.00– 5,872.49	8.9%	\$505–523
	290% - 299.99%	\$5,872.50– 6,074.99	9.2%	\$540–559
	300%+	\$6,075.00+	9.5%	\$577+

For incomes over 300 percent of the FPL, multiply the net income times .095 and round to the nearest dollar to get the premium amount.

Family Size	FPL%	Monthly Income	Premium Rate	Monthly Premium Range
5	100.01– 133%	\$2,370.01– 3,152.10	2.0%	\$47–63
	133.01– 139.99%	\$3,152.11– 3,317.99	3.0%	\$95–100
	140– 149.99%	\$3,318.00– 3,554.99	3.5%	\$116–124
	150– 159.99%	\$3,555.00– 3,791.99	4.0%	\$142–152
	160– 169.99%	\$3,792.00– 4,028.99	4.5%	\$171–181
	170– 179.99%	\$4,029.00– 4,265.99	4.9%	\$197–209
	180– 189.99%	\$4,266.00– 4,502.99	5.4%	\$230–243
	190– 199.99%	\$4,503.00– 4,739.99	5.8%	\$261–275
	200– 209.99%	\$4,740.00– 4,976.99	6.3%	\$299–314
	210– 219.99%	\$4,977.00– 5,213.99	6.7%	\$333–349
	220– 229.99%	\$5,214.00– 5,450.99	7.0%	\$365–382
	230–	\$5,451.00–	7.4%	\$403–421

	239.99%	5,687.99		
	240– 249.99%	\$5,688.00– 5,924.99	7.7%	\$438–456
	250– 259.99%	\$5,925.00– 6,161.99	8.1%	\$480–499
	260– 269.99%	\$6,162.00– 6,398.99	8.3%	\$511–531
	270– 279.99%	\$6,399.00– 6,635.99	8.6%	\$550–571
	280– 289.99%	\$6,636.00– 6,872.99	8.9%	\$591–612
	290– 299.99%	\$6,873.00– 7,109.99	9.2%	\$632–654
	300%+	\$7,110.00+	9.5%	\$675+

For incomes over 300 percent of the FPL, multiply the net income times .095 and round to the nearest dollar to get the premium amount.

Family Size	FPL%	Monthly Income	Premium Rate	Monthly Premium Range
6	100.01– 133%	\$2,715.01– 3,610.95	2.0%	\$54–72
	133.01– 139.99%	\$3,610.96– 3,800.99	3.0%	\$108–114
	140– 149.99%	\$3,801.00– 4,072.49	3.5%	\$133–143
	150– 159.99%	\$4,072.50– 4,343.99	4.0%	\$163–174
	160– 169.99%	\$4,344.00– 4,615.49	4.5%	\$195–208
	170– 179.99%	\$4,615.50– 4,886.99	4.9%	\$226–239
	180– 189.99%	\$4,887.00– 5,158.49	5.4%	\$264–279
	190– 199.99%	\$5,158.50– 5,429.99	5.8%	\$299–315
	200– 209.99%	\$5,430.00– 5,701.49	6.3%	\$342–359
	210– 219.99%	\$5,701.50– 5,972.99	6.7%	\$382–400
	220– 229.99%	\$5,973.00– 6,244.49	7.0%	\$418–437
	230–	\$6,244.50–	7.4%	\$462–482

48.1 BadgerCare Plus Premium Tables

	239.99%	6,515.99		
	240– 249.99%	\$6,516.00– 6,787.49	7.7%	\$502–523
	250– 259.99%	\$6,787.50– 7,058.99	8.1%	\$550–572
	260– 269.99%	\$7,059.00– 7,330.49	8.3%	\$586–608
	270– 279.99%	\$7,330.50– 7,601.99	8.6%	\$630–654
	280– 289.99%	\$7,602.00– 7,873.49	8.9%	\$677–701
	290– 299.99%	\$7,873.50– 8,144.99	9.2%	\$724–749
	300%+	\$8,145.00+	9.5%	\$774+

For incomes over 300 percent of the FPL, multiply the net income times .095 and round to the nearest dollar to get the premium amount.

Family Size	FPL%	Monthly Income	Premium Rate	Monthly Premium Range
7	100.01– 133%	\$3,060.84– 4,070.91	2.0%	\$61–81
	133.01– 139.99%	\$4,070.92– 4,285.16	3.0%	\$122–129
	140– 149.99%	\$4,285.17– 4,591.24	3.5%	\$150–161
	150– 159.99%	\$4,591.25– 4,897.32	4.0%	\$184–196
	160– 169.99%	\$4,897.33– 5,203.41	4.5%	\$220–234
	170– 179.99%	\$5,203.42– 5,509.49	4.9%	\$255–270
	180– 189.99%	\$5,509.50– 5,815.57	5.4%	\$298–314
	190– 199.99%	\$5,815.58– 6,121.66	5.8%	\$337–355
	200– 209.99%	\$6,121.67– 6,427.74	6.3%	\$386–405
	210– 219.99%	\$6,427.75– 6,733.82	6.7%	\$431–451
	220– 229.99%	\$6,733.83– 7,039.91	7.0%	\$471–493
	230–	\$7,039.92–	7.4%	\$521–544

	239.99%	7,345.99		
	240– 249.99%	\$7,346.00– 7,652.07	7.7%	\$566–589
	250– 259.99%	\$7,652.08– 7,958.16	8.1%	\$620–645
	260– 269.99%	\$7,958.17– 8,264.24	8.3%	\$661–686
	270– 279.99%	\$8,264.25– 8,570.32	8.6%	\$711–737
	280– 289.99%	\$8,570.33– 8,876.41	8.9%	\$763–790
	290– 299.99%	\$8,876.42– 9,182.49	9.2%	\$817–845
	300%+	\$9,182.50+	9.5%	\$872+

For incomes over 300 percent of the FPL, multiply the net income times .095 and round to the nearest dollar to get the premium amount.

Family Size	FPL%	Monthly Income	Premium Rate	Monthly Premium Range
8	100.01– 133%	\$3,407.51– 4,531.98	2.0%	\$68–91
	133.01– 139.99%	\$4,531.99– 4,770.49	3.0%	\$136–143
	140– 149.99%	\$4,770.50– 5,111.24	3.5%	\$167–179
	150– 159.99%	\$5,111.25– 5,451.99	4.0%	\$204–218
	160– 169.99%	\$5,452.00– 5,792.74	4.5%	\$245–261
	170– 179.99%	\$5,792.75– 6,133.49	4.9%	\$284–301
	180– 189.99%	\$6,133.50– 6,474.24	5.4%	\$331–350
	190– 199.99%	\$6,474.25– 6,814.99	5.8%	\$376–395
	200– 209.99%	\$6,815.00– 7,155.74	6.3%	\$429–451
	210– 219.99%	\$7,155.75– 7,496.49	6.7%	\$479–502
	220– 229.99%	\$7,496.50– 7,837.24	7.0%	\$525–549
	230–	\$7,837.25–	7.4%	\$580–605

48.1 BadgerCare Plus Premium Tables

	239.99%	8,177.99		
	240– 249.99%	\$8,178.00– 8,518.74	7.7%	\$630–656
	250– 259.99%	\$8,518.75– 8,859.49	8.1%	\$690–718
	260– 269.99%	\$8,859.50– 9,200.24	8.3%	\$735–764
	270– 279.99%	\$9,200.25– 9,540.99	8.6%	\$791–821
	280– 289.99%	\$9,541.00– 9,881.74	8.9%	\$849–879
	290– 299.99%	\$9,881.75– 10,222.49	9.2%	\$909–940
	300%+	\$10,222.50+	9.5%	\$971+

For incomes over 300 percent of the FPL, multiply the net income times .095 and round to the nearest dollar to get the premium amount.

Family Size	FPL%	Monthly Income	Premium Rate	Monthly Premium Range
9	100.01– 133%	\$3,754.18– 4,993.04	2.0%	\$75–100
	133.01– 139.99%	\$4,993.05– 5,255.82	3.0%	\$150–158
	140– 149.99%	\$5,255.83– 5,631.24	3.5%	\$184–197
	150– 159.99%	\$5,631.25– 6,006.66	4.0%	\$225–240
	160– 169.99%	\$6,006.67– 6,382.07	4.5%	\$270–287
	170– 179.99%	\$6,382.08– 6,757.49	4.9%	\$313–331
	180– 189.99%	\$6,757.50– 7,132.91	5.4%	\$365–385
	190– 199.99%	\$7,132.92– 7,508.32	5.8%	\$414–435
	200– 209.99%	\$7,508.33– 7,883.74	6.3%	\$473–497
	210– 219.99%	\$7,883.75– 8,259.16	6.7%	\$528–553
	220– 229.99%	\$8,259.17– 8,634.57	7.0%	\$578–604
	230–	\$8,634.58–	7.4%	\$639–667

	239.99%	9,009.99		
	240– 249.99%	\$9,010.00– 9,385.41	7.7%	\$694–723
	250– 259.99%	\$9,385.42– 9,760.82	8.1%	\$760–791
	260– 269.99%	\$9,760.83– 10,136.24	8.3%	\$810–841
	270– 279.99%	\$10,136.25– 10,511.66	8.6%	\$872–904
	280– 289.99%	\$10,511.67– 10,887.07	8.9%	\$936–969
	290– 299.99%	\$10,887.08– 11,262.49	9.2%	\$1,002–1,036
	300%+	\$11,262.50+	9.5%	\$1,070+

For incomes over 300 percent of the FPL, multiply the net income times .095 and round to the nearest dollar to get the premium amount.

Family Size	FPL%	Monthly Income	Premium Rate	Monthly Premium Range
10	100.01– 133%	\$4,100.84– 5,454.11	2.0%	\$82–109
	133.01– 139.99%	\$5,454.12– 5,741.16	3.0%	\$164–172
	140– 149.99%	\$5,741.17– 6,151.24	3.5%	\$201–215
	150– 159.99%	\$6,151.25– 6,561.32	4.0%	\$246–262
	160– 169.99%	\$6,561.33– 6,971.41	4.5%	\$295–314
	170– 179.99%	\$6,971.42– 7,381.49	4.9%	\$342–362
	180– 189.99%	\$7,381.50– 7,791.57	5.4%	\$399–421
	190– 199.99%	\$7,791.58– 8,201.66	5.8%	\$452–476
	200– 209.99%	\$8,201.67– 8,611.74	6.3%	\$517–543
	210– 219.99%	\$8,611.75– 9,021.82	6.7%	\$577–604
	220– 229.99%	\$9,021.83– 9,431.91	7.0%	\$632–660
	230–	\$9,431.92–	7.4%	\$698–728

48.1 BadgerCare Plus Premium Tables

	239.99%	9,841.99		
	240– 249.99%	\$9,842.00– 10,252.07	7.7%	\$758–789
	250– 259.99%	\$10,252.08– 10,662.16	8.1%	\$830–864
	260– 269.99%	\$10,662.17– 11,072.24	8.3%	\$885–919
	270– 279.99%	\$11,072.25– 11,482.32	8.6%	\$952–987
	280– 289.99%	\$11,482.33– 11,892.41	8.9%	\$1,022–1,058
	290– 299.99%	\$11,892.42– 12,302.49	9.2%	\$1,094–1,132
	300%+	\$12,302.50+	9.5%	\$1,169+

For incomes over 300 percent of the FPL, multiply the net income times .095 and round to the nearest dollar to get the premium amount.

48.1.3 Premiums for Adult Caretaker Families with Self-Employment Income

The table below includes premium amounts set at five percent of the countable household income for groups with self-employment income at or below 200 percent after subtracting *depreciation*, but above 200 percent and below 300 percent when the depreciation is included.

Families with self-employment income below 200 percent after subtracting depreciation but above 300 percent when including depreciation will pay either the five percent premium amount or the combined premiums for the children, whichever is greater.

Note: These amounts only apply to self-employed parents and caretakers who applied prior to February 1, 2014, and have their eligibility determined under non-MAGI rules. Self-employed parents and caretakers who apply on or after February 1, 2014, have their eligibility determined under MAGI rules, which considers depreciation to be an allowable expense. Eligibility ends March 31, 2014, for self-employed parents and caretakers with incomes over 100 percent of the FPL.

Group Size	201–211%	211–221%	221–231%	231–241%	241–251%	251–261%	261–271%	271–281%	281–291%	291–301%	301%–306%
1	99.00	104.00	109.00	114.00	119.00	124.00	129.00	134.00	139.00	144.00	148.00
2	134.00	140.00	147.00	154.00	160.00	167.00	174.00	180.00	187.00	194.00	200.00
3	168.00	177.00	185.00	194.00	202.00	210.00	219.00	227.00	236.00	244.00	252.00
4	203.00	213.00	223.00	233.00	244.00	254.00	264.00	274.00	284.00	294.00	304.00

5	238.00	250.00	261.00	273.00	285.00	297.00	309.00	321.00	332.00	344.00	356.00
6	272.00	286.00	300.00	313.00	327.00	340.00	354.00	367.00	381.00	395.00	408.00
7	307.00	322.00	338.00	353.00	368.00	384.00	399.00	414.00	430.00	445.00	460.00
8	342.00	359.00	376.00	393.00	410.00	427.00	444.00	461.00	478.00	495.00	512.00
9	377.00	396.00	414.00	433.00	452.00	471.00	489.00	508.00	527.00	546.00	565.00
10	412.00	432.00	453.00	473.00	494.00	514.00	535.00	555.00	576.00	596.00	617.00
11	446.00	469.00	491.00	513.00	535.00	558.00	580.00	602.00	624.00	647.00	669.00
12	481.00	505.00	529.00	553.00	577.00	601.00	625.00	649.00	673.00	697.00	721.00
13	516.00	542.00	568.00	593.00	619.00	645.00	670.00	696.00	722.00	747.00	773.00
14	551.00	578.00	606.00	633.00	661.00	688.00	716.00	743.00	770.00	798.00	825.00

*This page last updated in Release Number: 16-01
 Release Date: 02/15/2016
 Effective Date: 02/01/2016*

49 Health Care Choice

[View History](#)

49.1 HEALTH CARE CHOICE

For individuals whose eligibility is determined under **non-MAGI** rules:

EBD Eligibility	BadgerCare Plus Eligibility	System Choice
MS/NS/MAPP w/no premium	No premium	EBD
MS/NS/MAPP w/no premium	Premium	EBD
MS/NS/MAPP w/o premium	BadgerCare Plus Deductible	EBD
MAPP w/premium	No premium	BadgerCare Plus
NS Deductible	No premium	BadgerCare Plus
MAPP w/premium	Standard Plan with Premium	The program with the lesser premium
MAPP w/premium	Benchmark Plan with Premium	EBD

50.1 Federal Poverty Level Table

NS Deductible	Premium	Member Choice
MAPP Premium	Deductible	Member Choice
NS Deductible	Deductible	Member Choice

Note: The BadgerCare Benchmark plan ended on March 31, 2014.

For individuals whose eligibility is determined under *MAGI* rules:

Once an individual has been determined eligible for EBD Medicaid, he or she must be enrolled in EBD Medicaid, even if they are also eligible for BadgerCare Plus, unless they have a change in circumstances that results in ineligibility for EBD Medicaid. The only exception to this policy is pregnant women who are eligible for both EBD Medicaid and BadgerCare Plus. In these instances, the pregnant woman will be enrolled in BadgerCare Plus.

If someone is pending for EBD Medicaid or if they have an unmet deductible for EBD Medicaid, the individual is not considered eligible for EBD Medicaid and can enroll in BadgerCare Plus. Pending for EBD Medicaid includes, but is not limited to, waiting for a disability determination from DDB or not eligible for Medicare. If an individual enrolled in EBD Medicaid becomes ineligible for EBD Medicaid for any reason, including going over the asset limit or failure to pay a MAPP premium, he or she can enroll in BadgerCare Plus if he or she is still eligible to do so.

*This page last updated in Release Number: 14-01
Release Date: 02/07/14
Effective Date: 02/01/14*

50 Federal Poverty Level Table

[View History](#)

50.1 FEDERAL POVERTY LEVEL TABLE

Group Size	Annual FPL	100% FPL	133% FPL	150% FPL	156% FPL	191% FPL	201% FPL	300% FPL	306% FPL
1	\$11,880	\$990.00	\$1,316.70	\$1,485.00	\$1,544.40	\$1,890.90	\$1,989.90	\$2,970.00	\$3,029.40
2	16,020	\$1,335.00	\$1,775.55	\$2,002.50	\$2,082.60	\$2,549.85	\$2,683.35	\$4,005.00	\$4,085.10
3	20,160	\$1,680.00	\$2,234.40	\$2,520.00	\$2,620.80	\$3,208.80	\$3,376.80	\$5,040.00	\$5,140.80
4	24,300	\$2,025.00	\$2,693.25	\$3,037.50	\$3,159.00	\$3,867.75	\$4,070.25	\$6,075.00	\$6,196.50
5	28,440	\$2,370.00	\$3,152.10	\$3,555.00	\$3,697.20	\$4,526.70	\$4,763.70	\$7,110.00	\$7,252.20
6	32,580	\$2,715.00	\$3,610.95	\$4,072.50	\$4,235.40	\$5,185.65	\$5,457.15	\$8,145.00	\$8,307.90
7	36,730	\$3,060.83	\$4,070.91	\$4,591.25	\$4,774.90	\$5,846.19	\$6,152.28	\$9,182.50	\$9,366.15
8	40,890	\$3,407.50	\$4,531.98	\$5,111.25	\$5,315.70	\$6,508.33	\$6,849.08	\$10,222.50	\$10,426.95

9	45,050	\$3,754.17	\$4,993.04	\$5,631.25	\$5,856.50	\$7,170.46	\$7,545.88	\$11,262.50	\$11,487.75
10	49,210	\$4,100.83	\$5,454.11	\$6,151.25	\$6,397.30	\$7,832.59	\$8,242.68	\$12,302.50	\$12,548.55
11	53,370	\$4,447.50	\$5,915.18	\$6,671.25	\$6,938.10	\$8,494.73	\$8,939.48	\$13,342.50	\$13,609.35
12	57,530	\$4,794.17	\$6,376.24	\$7,191.25	\$7,478.90	\$9,156.86	\$9,636.28	\$14,382.50	\$14,670.15
13	61,690	\$5,140.83	\$6,837.31	\$7,711.25	\$8,019.70	\$9,818.99	\$10,333.08	\$15,422.50	\$15,730.95
14	65,850	\$5,487.50	\$7,298.38	\$8,231.25	\$8,560.50	\$10,481.13	\$11,029.88	\$16,462.50	\$16,791.75
15	70,010	\$5,834.17	\$7,759.44	\$8,751.25	\$9,101.30	\$11,143.26	\$11,726.68	\$17,502.50	\$17,852.55
16	74,170	\$6,180.83	\$8,220.51	\$9,271.25	\$9,642.10	\$11,805.39	\$12,423.48	\$18,542.50	\$18,913.35
17	78,330	\$6,527.50	\$8,681.58	\$9,791.25	\$10,182.90	\$12,467.53	\$13,120.28	\$19,582.50	\$19,974.15
18	82,490	\$6,874.17	\$9,142.64	\$10,311.25	\$10,723.70	\$13,129.66	\$13,817.08	\$20,622.50	\$21,034.95
each additional person	\$4,160	\$346.67	\$461.07	\$520.00	\$540.80	\$662.13	\$696.80	\$1,040.00	\$1,060.80
		BadgerCare Plus Extensions Trigger BadgerCare Plus Adults Limit	BadgerCare Plus Extension Six-Month Premium Limit	BadgerCare Plus Child Deductible Limit	BadgerCare Plus Limit for Children 6–18 Years Old Subject to Access, Backdating, and <i>PE</i>	BadgerCare Plus Limit for Children 1–5 Years Old Subject to Access, Backdating, and PE	BadgerCare Plus Children Premiums Limit	BadgerCare Plus Pregnant Women Deductible Limit	BadgerCare Plus Pregnant Women Children/ <i>FPOS</i> Limit

An FPL calculator can be found at www.safetyweb.org/fpl.php.

*This page last updated in Release Number: 16-01
Release Date: 02/15/2016
Effective Date: 02/01/2016*

51 BadgerCare Plus Medical Status Codes

[View History](#)

51.1 BADGERCARE PLUS MEDICAL STATUS CODES

For a complete list of Medical Status Codes see Process Help [Chapter 81 Forward Health iChange](#)

The following Medical Status Codes are in effect April 1, 2014 for all BadgerCare Plus members.

Med Stat	Description	Income (FPL)	BadgerCare Plus Plan	Subject to Co-Pay	Premium	Funding
BA	Pregnant Woman	>0 - 100%	Standard	No	No	T19

51.1 BadgerCare Plus Medical Status Codes

AB	Pregnant Woman	>100 - 200%	Standard	No	No	T19
9C	Pregnant Woman	>200 - 300%	Standard	No	No	T19
9M	Pregnant Woman <i>Deductible</i>	> 300%	Standard	No	No	T19
9D	Pregnant minor under age 19	>200 - 300%	Standard	No	No	T19
BS	Pregnant non- qualifying immigrant	0 - 200%	Standard	No	No	T21 Separate CHIP
9A	Pregnant non- qualifying immigrant	>200 - 300%	Standard	No	No	T21 Separate CHIP
BX	Pregnant Inmate	0 - 200%	Standard	No	No	State Funded
9B	Pregnant Inmate	>200 - 300%	Standard	No	No	State Funded
N1	CEN - Mom on T19 on DOB	0 - 100%	Standard	No	No	T19
N4	CEN - Mom on T19 on DOB	>100 - 133%	Standard	No	No	T19
7V	CEN - Mom on T19 on DOB	>133 - 150%	Standard	No	No	T19
7W	CEN - Mom on T19 on DOB	>150 - 200%	Standard	Yes	No	T19
9H	CEN - Mom on T19 on DOB	>200%	Standard	Yes	No	T19
BE	Child under age 19	0 - 100%	Standard	No	No	T19
BJ	Child under age 6	>100 - 133%	Standard	No	No	T19
7J	Child under age 6	>133 - 150%	Standard	No	No	T19
7N	Child < age 1	>150 - 200%	Standard	Yes	No	T19
9F	Child < age 1	>200 - 250%	Standard	Yes	No	T19
9G	Child < age 1	>250% - 300%	Standard	Yes	No	T19
7F	Child age 1 through 5	>150 - 185%	Standard	No	No	T19
C3	Child age 1 through 5	>185 - 200%	Standard	Yes	No	T21 Separate CHIP
TF	Child age 1 through 5 who is a tribal member	>185% - 200%	Standard	No	No	T21 Separate CHIP
9U	Child age 6 through 18	>100 - 133%	Standard	No	No	T19

BC+ Handbook Release 16-01

99	Child age 6 through 18	>133 - 150%	Standard	Yes	No	T19
BG	Child age 6 through 18	>150 - 200%	Standard	Yes	No	T21 Separate CHIP
TG	Child age 6 through 18 who is a tribal member	>150% - 200%	Standard	No	No	T21 Separate CHIP
9K	Child age 1 through 18	>200 - 250%	Standard	Yes	Yes	T21 Separate CHIP
T8	Child age 1 through 18 who is a tribal member	>200 - 250%	Standard	No	No	T21 Separate CHIP
9L	Child age 1 through 18	>250 - 300%	Standard	Yes	Yes	T21 Separate CHIP
T9	Child age 1 through 18 who is a tribal member	>250 - 300%	Standard	No	No	T21 Separate CHIP
9N	Child, under age 19 deductible	> 150%	Standard	Yes	No	T19
NC	Child under age 19 Residing in a medical institution.	≤200%	Standard	No	No	T19
9Z	12-month BadgerCare Plus Transitional Benefit Child <19	N/A	Standard	Yes	No	T21 Separate CHIP
9Y	Adult (Parent or Caretaker)	0%	Standard	No	No	T19
BL	Parents/Caretakers	>0 - 100%	Standard	Yes	No	T19
BY	Youths exiting out of home care up to age 21	N/A	Standard	Yes	No	T19
9Q	Former Foster Care Youth, up to age 26	N/A	Standard	Yes	No	T19
9W	Childless Adults	0%	Standard	No	No	T19
9X	Transitional Childless Adults	0%	Standard	No	No	T19
9P	Childless Adults	>0 - 100%	Standard	Yes	No	T19
9V	Transitional Childless Adults	>0 - 100%	Standard	Yes	No	T19
9R	Earnings Extension – 12 Mo (Adults)	> 133%	Standard	Yes	Yes	T19
JM	Earnings Extension, Disabled Adult	> 100%	Standard	Yes	No	T19

51.1 BadgerCare Plus Medical Status Codes

	(effective July 1, 2014)					
JJ	Child/Spousal Support Extension, Disabled Adult (effective July 1, 2014)	> 100%	Standard	Yes	No	T19
JC	Earnings Extension, Non-disabled Adult (effective July 1, 2014)	> 100%, < 133%	Standard	Yes	Yes**	T19
JL	Child/Spousal Support Extension, Non-disabled Adult (effective July 1, 2014)	> 100%, < 133%	Standard	Yes	No	T19
9S	Child Support Extension – 4 Mo (Adults)	> 133%	Standard	Yes	Yes	T19
X8	Earnings extension - 12 Mo, child under 19	>100%	Standard	No	No	T19
X9	Child/Spousal Support extension - 4 Mo, child under 19	>100%	Standard	No	No	T19
BU	Presumptive eligibility for a Child age 1-18	0 - 150%	Standard	No	No	T19
7S	Presumptive eligibility for a Child ages 1 through 5	>150 - 185%	Standard	No	No	T19
EC	Presumptive eligibility for a Child <age 1	0 - 133%	Standard	No	No	T19
7Q	Presumptive eligibility for a Child <age 1	>133 -200%	Standard	No	No	T19
9J	Presumptive eligibility for a Child <age 1	>200 - 300%	Standard	No	No	T19
BV	Presumptive eligibility for a Pregnant Woman	0 - 200%	Standard	No	No	T19
9E	Presumptive eligibility for a Pregnant Woman	>200 - 300%	Standard	No	No	T19
PP	Presumptive eligibility for parents/caretakers	0 – 100%	Standard	No	No	T19
PN	Presumptive eligibility for childless adults	0 – 100%	Standard	No	No	T19

AE*	Alien; Emergency- Services-Only	≤300%	Emergency- Service-Only	N/A	No	T19
FS	Family Planning Services	≤300%	FPS Services Only	N/A	No	T19

*See BadgerCare Plus Emergency Services Income Limits in [39.1](#).

**Premiums only for months 7 to 12 extension.

*This page last updated in Release Number: 15-01
Release Date: 05/15/2015
Effective Date: 05/15/2015*

52 Core Plan Health Insurance

[View History](#)

52.1 CORE PLAN HEALTH INSURANCE

The BadgerCare Plus Core Plan ended on March 31, 2014. To see previously covered services under the BadgerCare Plus Core Plan, select "View History" in the upper right hand corner for more information.

*This page last updated in Release Number: 14-02
Release Date: 05/14/14
Effective Date: 04/01/14*